

COMMUNITY DEVELOPMENT AGENCY  
FEDERAL GRANTS DIVISION

Brian C. Crawford  
DIRECTOR

Roy Bateman  
COMMUNITY DEVELOPMENT  
COORDINATOR

May 8, 2012

Mailing Address:  
Marin County Civic Center  
3501 Civic Center Drive  
Suite 308  
San Rafael, CA 94903

Office Location:  
*Do not use for mail*  
899 Northgate Drive  
Suite 408  
San Rafael, CA

415 473 6279 T  
415 473 4061 F  
California Relay Service 711

[www.marincounty.org/cdbg](http://www.marincounty.org/cdbg)

Marin County Board of Supervisors  
3501 Civic Center Drive  
San Rafael, CA 94903

**SUBJECT:** Federal Fiscal Year 2012 Amendments to Consolidated Plan  
(Including Budgets for the Community Development Block Grant  
Program (CDBG), the HOME Investment Partnerships Program  
(HOME), and the Housing Opportunities for Persons with AIDS  
Program (HOPWA))

Dear Board Members,

**RECOMMENDATIONS:**

1. Hold a public hearing on May 8, 2012, for comment on:
  - A. Marin County's housing and community development needs.
  - B. Marin County's community development performance.
  - C. The Consolidated Plan and amendments to the Consolidated Plan, including activities proposed for federal Fiscal Year 2012 funding from the Community Development Block Grant Program (CDBG), the HOME Investment Partnerships Program (HOME), and the Housing Opportunities for Persons with AIDS Program (HOPWA).
  - D. The proposed budget for the use of federal Fiscal Year 2012 (2012-13 local program year) CDBG funds, included in the Consolidated Plan amendments.
  - E. The proposed reprogramming of past years' CDBG funds to new activities and the proposed use of CDBG program income, included in the Consolidated Plan amendments.
  - F. The proposed budget for the use of federal Fiscal Year 2012 (2012-13 local program year) HOME funds, included in the Consolidated Plan amendments.

- G. The proposed reprogramming of past years' HOME funds to new activities and the proposed use of HOME program income, included in the Consolidated Plan amendments. *(Please see Summary section for new information about proposed reprogramming of \$163,250 in Fiscal Year 2010 HOME funds from The Redwoods to Housing for Working Families [Homeward Bound of Marin] and Marinwood Plaza [BRIDGE Housing Corporation].)*
  - H. The proposed budget for the use of federal Fiscal Year 2012 (2012-13 local program year) HOPWA funds, included as an information item in the Consolidated Plan amendments.
  - I. The Local Standard for Affordable Rents.
  - J. The Civil Rights Policy.
  - K. The Residential Antidisplacement and Relocation Assistance Plan.
2. Following public testimony, approve the Consolidated Plan amendments and related documents, as attached, including the items listed above, and authorize any budget changes necessary to implement these actions.
  3. Following public testimony, approve the Resolution authorizing staff to submit the Consolidated Plan amendments to the U.S. Department of Housing and Urban Development (HUD), with the understanding that staff will adjust the budget amounts for specific CDBG and HOME projects, in accordance with the previous recommendations of the CDBG Priority Setting Committee, after HUD announces any final changes in our Fiscal Year 2012 formula grant amounts, and authorize staff to act in connection with the submission of the Consolidated Plan amendments and to provide such additional information as HUD may require.
  4. Announce that copies of the Consolidated Plan (as amended) are available from the Community Development Agency, and that program files, records regarding past use of CDBG, HOME, and HOPWA funds, the Local Standard for Affordable Rents, the Civil Rights Policy, the Residential Antidisplacement and Relocation Assistance Plan, and the Nondiscrimination Policy are available for inspection at the Community Development Agency.

**SUMMARY:**

On May 4, 2010, the Marin County Board of Supervisors approved the Consolidated Plan for Fiscal Years 2010-14, the document required by HUD as our application for formula funding from the Community Development Block Grant Program (CDBG) and the HOME Investment Partnerships Program (HOME). The five-year Consolidated Plan included an analysis of needs and statements of policies for the entire period, as well as CDBG and HOME project budgets for the first year of the five-year period. In the second, third, fourth, and fifth years, the Consolidated Plan must be amended with an "Action Plan" to add each year's CDBG and HOME project budgets. On July 1, 2012, we will begin the third year covered by the Consolidated Plan, so an annual amendment is required.

The attached amendments to Marin County's five-year Consolidated Plan update the policy section and add budgets for the use of an estimated \$1,166,041 in federal Fiscal Year 2012 CDBG funds and an estimated \$595,350 in federal Fiscal Year 2012 HOME funds. The Consolidated Plan also reports on the planned use of an estimated \$337,700 in federal Fiscal Year 2012 HOPWA funds. HUD allocates HOPWA formula funds to San Francisco on behalf of Marin, San Francisco, and San Mateo Counties, so that Marin's HOPWA allocation is formally included in San Francisco's Consolidated Plan. Staff is recommending that the HOPWA funds available to Marin be used to continue an ongoing rental assistance program administered by the Marin Housing Authority. The budget also includes CDBG and HOME funds from prior years which are recommended for reprogramming (reallocation) to new projects, and allocations of CDBG and HOME program income. The federal Fiscal Year 2012 CDBG, HOME, and HOPWA funds become available to the County at the start of the local program year, which runs from July 1, 2012 to June 30, 2013. CDBG, HOME, and HOPWA grants are carried in Fund 22050, Fund Center 4000071000, where they will be held until the 2012-13 fiscal year begins, at which time they will be transferred to Fund Centers 4000991025 (CDBG), 4000992018 (HOME), and 4000993008 (HOPWA).

Compared to last year's grants, the estimated 2012-13 grant amounts represent a 19% decrease in Marin's CDBG allocation, a 46% decrease in HOME, and a 1% decrease in HOPWA.

The CDBG and HOME budget information in the attached Consolidated Plan was developed following one workshop, five public hearings held by the County in the Planning Areas, one hearing held by the Novato City Council, one hearing held by the San Rafael City Council, and one hearing held by the Countywide Priority Setting Committee on March 29, 2012. Because HUD might make minor changes in its calculations of the County's final CDBG and HOME formula grant allocations, each hearing resulted in a set of instructions for staff on how to adjust the funding amounts for each project after the final grant amount is known.

On April 25, 2012, The Redwoods, a senior housing complex in Mill Valley, relinquished \$163,250 in 2010 HOME funds which were being held for its renovation project. Staff recommends that this amount be used to increase the HOME allocation for Housing for Working Families (Homeward Bound of Marin) by \$79,026 and to provide an \$84,224 HOME allocation to Marinwood Plaza (BRIDGE Housing Corporation). Because of HUD timing requirements that require the County to put the 2010 HOME funds under contract quickly, staff recommends that the Board of Supervisors make this allocation today, but that the decision be reported at the next meeting of the Countywide Priority Setting Committee so that the Committee will have an opportunity to review the decision and possibly recommend a different use of the funds. In the event that the Priority Setting Committee recommends a change, and the Board agrees, the Board could amend the Homeward Bound HOME contract to switch the source of funds from 2010 HOME funds to the 2012 HOME funds already approved by the Priority Setting Committee for the Homeward Bound project.

The attached draft Consolidated Plan Amendment includes only the funding recommendations that were approved by the Countywide Priority Setting Committee on March 29, 2012. Staff recommends that those recommendations be changed to budget the \$163,250 in 2010 HOME funds from The Redwoods as outlined in the above paragraph. In order to meet HUD's timing and commitment requirements for

the 2010 HOME funds, staff recommends that the 2010 funds be allocated to the project which is most ready to proceed, which is the Homeward Bound proposal. This can be accomplished by making a dollar-for-dollar trade of new and reprogrammed funds between Homeward Bound and BRIDGE Housing, so that all the reprogrammed HOME funds go to Homeward Bound. This would result in a recommended revised allocation of HOME funds for these two projects as follows:

Project	2012-13 HOME Funds	HOME Program Income and Reprogrammed Funds	Total
Housing for Working Families (Homeward Bound of Marin)	\$362,288 (an \$84,224 decrease from the amount approved by the Priority Setting Committee)	\$168,250 (a \$163,250 increase from the amount approved by the Priority Setting Committee)	\$530,538 (a \$79,026 increase from the amount approved by the Priority Setting Committee)
Marinwood Plaza (BRIDGE Housing Corporation)	\$84,224 (an \$84,224 increase from the amount approved by the Priority Setting Committee)	0	\$84,224 (an \$84,224 increase from the amount approved by the Priority Setting Committee)

**FISCAL/STAFFING IMPACT:**

The amendments to the Consolidated Plan serve as Marin County's application for federal CDBG and HOME grants, which the County then distributes to eligible projects sponsored by local nonprofit organizations and public agencies. Acceptance of these awards has no impact on the General Fund.

**REVIEWED BY:**

- Department of Finance                       N/A
- County Counsel                                       N/A
- Human Resources                                       N/A

**SIGNATURE:**



Roy Bateman  
Community Development Coordinator

RESOLUTION NO. \_\_\_\_\_

RESOLUTION OF THE MARIN COUNTY BOARD OF SUPERVISORS AUTHORIZING  
SUBMISSION OF AMENDMENTS TO THE CONSOLIDATED PLAN  
FOR THE USE OF COMMUNITY DEVELOPMENT BLOCK GRANT PROGRAM AND  
HOME INVESTMENT PARTNERSHIPS PROGRAM FUNDS

**WHEREAS**, the Board of Supervisors of the County of Marin, in cooperation with eleven cities in the County, has adopted a community development strategy establishing six interjurisdictional Community Development Block Grant (CDBG) citizen participation/planning areas, allocating a portion of Federal Fiscal Year 2012 (2012-13 local program year) CDBG funding to the planning areas and establishing a countywide allocation of a portion of its CDBG funds for housing; and

**WHEREAS**, one informational workshop was held, and seven local public hearings were held to elicit public response and program ideas; and

**WHEREAS**, the Countywide Priority Setting Committee, the countywide citizen participation body for the CDBG Program and the HOME Investment Partnerships Program (HOME), conducted a public hearing on March 29, 2012 to solicit public testimony on community development objectives and the projected use of CDBG and HOME funds, and to make funding recommendations to be forwarded to the Board of Supervisors of the County of Marin; and

**WHEREAS**, a notice of availability of the draft Consolidated Plan Action Plan amendment for Fiscal Year 2012 (2012-13), including the proposed CDBG and HOME Fiscal Year 2012 budgets, has been published in the Marin Independent Journal, a newspaper of general circulation; and

**WHEREAS**, the Board of Supervisors of the County of Marin conducted a public hearing on May 8, 2012, to hear public testimony and consider in full the draft Consolidated Plan and associated documents; and

**WHEREAS**, the Board of Supervisors of the County of Marin has certified that the Community Development Program has been developed with citizen input and gives maximum feasible priority to activities which will principally benefit low or moderate income persons;

**NOW, THEREFORE, BE IT RESOLVED**, that the Board of Supervisors of the County of Marin hereby authorizes County staff to sign and submit the Consolidated Plan, including the required Certifications and associated documents, to the United States Department of Housing and Urban Development, and authorizes staff to act in connection with the submission of the Consolidated Plan and to provide such additional information and non-substantial budget adjustments as may be required.

**PASSED AND ADOPTED** at a regular meeting of the Board of Supervisors of the County of Marin held on this 8th day of May 2012, by the following vote:

AYES:

NOES:

ABSENT:

ABSTAIN:

---

PRESIDENT, BOARD OF SUPERVISORS

ATTEST:

---

DEPUTY CLERK

**COUNTY OF MARIN**  
**COMMUNITY DEVELOPMENT BLOCK GRANT PROGRAM**

---

**LOCAL STANDARD FOR AFFORDABLE RENTS**

In order for most rental housing projects to qualify for Community Development Block Grant assistance, a specified percentage of the units must be occupied by low and moderate income households at affordable rents. The Community Development Block Grant regulations at 24 CFR 570.208(a)(3) require that localities define "affordable rents" for this purpose.

It is the policy of the County of Marin that, for the purposes of 24 CFR 570.208(a)(3), for each dwelling unit, affordable rent equals the greater of:

- (a) 30% of the occupant household's gross income, or
- (b)  $30\% \times 1.3 \times$  the San Francisco Primary Metropolitan Statistical Area Very Low-Income limit, as published by the U.S. Department of Housing and Urban Development, for the appropriate household size for the unit.

<u>Number of Bedrooms</u>	<u>Appropriate Household Size</u>
0	1
1	2
2	3
3	5
4	6

(Appropriate household size is  
1.5 persons per bedroom,  
rounding upward.)

Part (b) of this standard may not be applied to projects with less than four individual dwelling units. Part (b) of this standard may not be applied to existing tenants already in occupancy if it would result in a rent increase beyond normal annual increases in debt service and operating expenses.

This Local Standard for Affordable Rents is to be used solely for determining whether projects meet Community Development Block Grant Program eligibility standards, and does not in any way supersede the requirements of the Uniform Relocation Assistance and Real Property Acquisition Policies Act of 1970, as amended, Section 104(d) of the Housing and Community Development Act of 1974, as amended, or the federal and local regulations and policies implementing those statutes.

## COUNTY OF MARIN

---

### CIVIL RIGHTS POLICY

In accordance with requirements for receiving funding from the U.S. Department of Housing and Urban Development, it is the policy of the County of Marin that:

The use of excessive force by law enforcement agencies within its jurisdiction against any individuals engaged in non-violent civil rights demonstrations is prohibited; and

Applicable state and local laws against physically barring entrance to or exit from a facility or location which is the subject of such non-violent civil rights demonstrations within its jurisdiction will be enforced.

### RESIDENTIAL ANTIDISPLACEMENT AND RELOCATION ASSISTANCE PLAN

In accordance with the replacement housing requirements of Section 104(d) of the Housing and Community Development Act of 1974, as amended, it is the policy of the County of Marin that:

All reasonable steps, consistent with other goals and objectives of the Community Development Block Grant Program, the Housing Opportunities for Persons with AIDS Program, the HOME Investment Partnerships Program, and the Homelessness Prevention and Rapid Re-Housing Program, will be taken to minimize the displacement of families and individuals from their homes and neighborhoods as a result of any activities assisted by the Community Development Block Grant Program, the Housing Opportunities for Persons with AIDS Program, the HOME Investment Partnerships Program, or the Homelessness Prevention and Rapid Re-Housing Program. In its evaluation of project proposals, Marin County will give substantially lower priority to projects which will cause involuntary displacement or which will cause rents to rise so as to cause involuntary economic displacement of residential tenants. In all cases, Marin County will carefully weigh the benefits of a proposed project against any hardship it might impose on potential displacees, giving special consideration to the shortage of low-priced rental housing in Marin County.

In accordance with the requirements of 24 CFR 570.606(c)(1), if any occupied or vacant occupiable low/moderate-income dwelling units are demolished or converted to a use other than low/moderate-income dwelling units in connection with an activity assisted by Community Development Block Grant Program funds, Housing Opportunities for Persons with AIDS Program funds, HOME Investment Partnerships Program funds, or Homelessness Prevention and Rapid Re-Housing Program funds, the demolished or converted units will be replaced with low/moderate-income dwelling units which are located within Marin County, which are sufficient in number and size to house no fewer than the



number of occupants who could have been housed in the units that are demolished or converted, which are in standard condition, which are initially available for occupancy during the period required by 24 CFR 570.606(c)(1)(ii)(D), and which will remain as low/moderate-income dwelling units for at least 10 years.

Any eligible displaced person will be given relocation assistance as required by all applicable regulations, including 24 CFR 570.606(c)(2). Any displaced person who is eligible under 24 CFR 570.606(c)(2) will be advised of the option to receive benefits under either Section 104(d) of the Housing and Community Development Act of 1974, as amended, or 49 CFR 24.

If Community Development Block Grant Program funds, Housing Opportunities for Persons with AIDS Program funds, HOME Investment Partnerships Program funds, or Homelessness Prevention and Rapid Re-Housing Program funds are committed for any activity that would directly result in the demolition of low/moderate-income dwelling units or the conversion of low/moderate-income dwelling units to another use, the County will make public and submit to the U.S. Department of Housing and Urban Development the information required by 24 CFR 570.606(c)(1)(iii).

#### **AVAILABILITY OF INFORMATION**

Additional information about the Community Development Block Grant (CDBG) Program, the Housing Opportunities for Persons with AIDS Program, the HOME Investment Partnerships Program, and the Homelessness Prevention and Rapid Re-Housing Program is available from Roy Bateman at the Marin County Community Development Agency, Federal Grants Division, 899 Northgate Drive, Room 408, San Rafael, California, phone 499-6698. This information includes copies of the Consolidated Plan, records regarding past use of funds, a plan for minimizing the displacement of persons as a result of CDBG activities, a plan to assist persons actually displaced by CDBG activities, and an assessment of Marin County's housing and community development performance prepared by the U.S. Department of Housing and Urban Development. Copies of documents are available in accessible formats upon request.

#### **COUNTY OF MARIN** **NOTICE OF NONDISCRIMINATION POLICY**

The County of Marin does not discriminate on the basis of handicap in violation of 24 CFR Part 8 in admission or access to, or treatment or employment in, its federally assisted programs and activities, including those funded by the Community Development Block Grant Program, the HOME Investment Partnerships Program, the Housing Opportunities for Persons With AIDS Program, and the Homelessness Prevention and Rapid Re-Housing Program. Anyone with questions about this policy or the activities of the programs listed above may contact Roy Bateman at the Marin County Community Development Agency, Federal Grants Division, 65 Mitchell Boulevard, Suite 200-C, San Rafael, phone 473-6698. The person who has been

designated to process grievances under this policy is William Campagna, Section 504 Coordinator, Marin County Civic Center, 3501 Civic Center Drive, Room 304, San Rafael, California 94903, phone 473-6065. Information about the existence and location of accessible services, activities, and facilities is available from the Section 504 Compliance Office, Marin County Civic Center, 3501 Civic Center Drive, Room 304, San Rafael, California 94903, phone 473-6065. People using TTY devices may reach all County of Marin offices, including the Section 504 Compliance Office and the Federal Grants Division Office, at 473-3232, or through the California Relay Service at 711.

# **COUNTY OF MARIN CONSOLIDATED PLAN AMENDMENTS FOR FISCAL YEAR 2012**

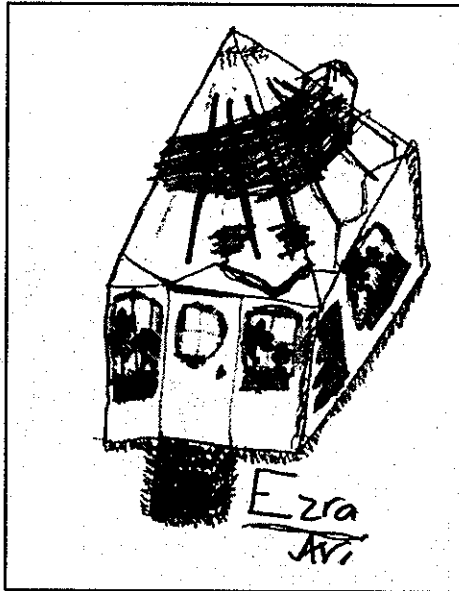

Original art by Avi and Ezra Thaler

## **INCLUDING PROJECT BUDGETS FOR:**

- ◆ **Community Development Block Grant Program  
(Federal Fiscal Year 2012)  
(Local Program Year July 1, 2012-June 30, 2013)**
  
- ◆ **HOME Investment Partnerships Program  
(Federal Fiscal Year 2012)  
(Local Program Year July 1, 2012-June 30, 2013)**

**Prepared by the Marin County Community Development Agency,  
Federal Grants Division**

**Approved by the Marin County Board of Supervisors on  
May 8, 2012**

Application for Federal Assistance SF-424		Version 02
*1. Type of Submission:		*2. Type of Application * If Revision, select appropriate letter(s)
<input type="checkbox"/> Preapplication		<input checked="" type="checkbox"/> New
<input checked="" type="checkbox"/> Application		<input type="checkbox"/> Continuation *Other (Specify)
<input type="checkbox"/> Changed/Corrected Application		<input type="checkbox"/> Revision _____
3. Date Received:	4. Applicant Identifier: CDBG FY 2012	
5a. Federal Entity Identifier:		*5b. Federal Award Identifier:
<b>State Use Only:</b>		
6. Date Received by State:		7. State Application Identifier:
<b>8. APPLICANT INFORMATION:</b>		
*a. Legal Name: County of Marin		
*b. Employer/Taxpayer Identification Number (EIN/TIN): 94-6000519		*c. Organizational DUNS: 078787744
<b>d. Address:</b>		
*Street 1:	<u>Marin County Community Development Agency</u>	
Street 2:	<u>3501 Civic Center Drive, Room 308</u>	
*City:	<u>San Rafael</u>	
County:	<u>Marin</u>	
*State:	<u>California</u>	
Province:	_____	
*Country:	<u>USA</u>	
*Zip / Postal Code	<u>94903</u>	
<b>e. Organizational Unit:</b>		
Department Name: Marin County Community Development Agency		Division Name: Federal Grants Division
<b>f. Name and contact information of person to be contacted on matters involving this application:</b>		
Prefix: _____	*First Name: <u>Roy</u>	
Middle Name: _____		
*Last Name: <u>Bateman</u>		
Suffix: _____		
Title:	<u>Community Development Coordinator</u>	
Organizational Affiliation: <u>Marin County Community Development Agency</u>		
*Telephone Number: (415) 473-6698		Fax Number: (415) 473-7880
*Email: <u>rbateman@marincounty.org</u>		

**Application for Federal Assistance SF-424**

Version 02

**\*9. Type of Applicant 1: Select Applicant Type:**

B. County Government

Type of Applicant 2: Select Applicant Type:

Type of Applicant 3: Select Applicant Type:

\*Other (Specify)

**\*10 Name of Federal Agency:**

U.S. Department of Housing and Urban Development

**11. Catalog of Federal Domestic Assistance Number:**

14.218

**CFDA Title:**

Community Development Block Grant Program

**\*12 Funding Opportunity Number:**

\*Title:

**13. Competition Identification Number:**

Title:

**14. Areas Affected by Project (Cities, Counties, States, etc.):**

Marin County, California

**\*15. Descriptive Title of Applicant's Project:**Community Development Block Grant Program (Urban County Entitlement Grant)  
Program Year 2012-13  
Federal Fiscal Year 2012

Application for Federal Assistance SF-424		Version 02
<b>16. Congressional Districts Of:</b>		
*a. Applicant: CA-006	*b. Program/Project: CA-006	
<b>17. Proposed Project:</b>		
*a. Start Date: July 1, 2012	*b. End Date: June 30, 2013	
<b>18. Estimated Funding (\$):</b>		
*a. Federal	\$1,166,041	
*b. Applicant		
*c. State		
*d. Local		
*e. Other		
*f. Program Income	450,000 (estimated)	
*g. TOTAL	\$1,616,041 (estimated)	
<b>*19. Is Application Subject to Review By State Under Executive Order 12372 Process?</b>		
<input type="checkbox"/> a. This application was made available to the State under the Executive Order 12372 Process for review on _____		
<input type="checkbox"/> b. Program is subject to E.O. 12372 but has not been selected by the State for review.		
<input checked="" type="checkbox"/> c. Program is not covered by E. O. 12372		
<b>*20. Is the Applicant Delinquent On Any Federal Debt? (If "Yes", provide explanation.)</b>		
<input type="checkbox"/> Yes <input checked="" type="checkbox"/> No		
21. *By signing this application, I certify (1) to the statements contained in the list of certifications** and (2) that the statements herein are true, complete and accurate to the best of my knowledge. I also provide the required assurances** and agree to comply with any resulting terms if I accept an award. I am aware that any false, fictitious, or fraudulent statements or claims may subject me to criminal, civil, or administrative penalties. (U. S. Code, Title 218, Section 1001)		
<input checked="" type="checkbox"/> ** I AGREE		
** The list of certifications and assurances, or an internet site where you may obtain this list, is contained in the announcement or agency specific instructions		
<b>Authorized Representative:</b>		
Prefix: _____	*First Name: <u>Matthew</u>	
Middle Name: _____		
*Last Name: <u>Hymel</u>		
Suffix: _____		
*Title: County Administrator		
*Telephone Number: (415) 473-6358	Fax Number: (415) 473-4104	
* Email: mhymel@marincounty.org		
*Signature of Authorized Representative:		*Date Signed: May 9, 2012

**Application for Federal Assistance SF-424**

Version 02

**\*Applicant Federal Debt Delinquency Explanation**

The following should contain an explanation if the Applicant organization is delinquent of any Federal Debt.

[Empty text area for explanation]

**Application for Federal Assistance SF-424** Version 02

<b>*1. Type of Submission:</b> <input type="checkbox"/> Preapplication <input checked="" type="checkbox"/> Application <input type="checkbox"/> Changed/Corrected Application	<b>*2. Type of Application</b> * If Revision, select appropriate letter(s) <input checked="" type="checkbox"/> New <input type="checkbox"/> Continuation    *Other (Specify) _____ <input type="checkbox"/> Revision	
--	---	--

3. Date Received:	4. Applicant Identifier: <span style="float: right;">HOME FY 2012</span>
-------------------	--

5a. Federal Entity Identifier:	*5b. Federal Award Identifier:
--------------------------------	--------------------------------

**State Use Only:**

6. Date Received by State:	7. State Application Identifier:
----------------------------	----------------------------------

**8. APPLICANT INFORMATION:**

\*a. Legal Name: County of Marin

*b. Employer/Taxpayer Identification Number (EIN/TIN): 94-6000519	*c. Organizational DUNS: 078787744
--	---------------------------------------

**d. Address:**

\*Street 1: Marin County Community Development Agency

Street 2: 3501 Civic Center Drive, Room 308

\*City: San Rafael

County: Marin

\*State: California

Province: \_\_\_\_\_

\*Country: USA

\*Zip / Postal Code 94903

**e. Organizational Unit:**

Department Name: Marin County Community Development Agency	Division Name: Federal Grants Division
---	---

**f. Name and contact information of person to be contacted on matters involving this application:**

Prefix: \_\_\_\_\_ \*First Name: Roy

Middle Name: \_\_\_\_\_

\*Last Name: Bateman

Suffix: \_\_\_\_\_

Title: Community Development Coordinator

Organizational Affiliation:  
Marin County Community Development Agency

*Telephone Number: (415) 473-6698	Fax Number: (415) 473-7880
-----------------------------------	----------------------------

\*Email: rbateman@marincounty.org



**Application for Federal Assistance SF-424**

Version 02

**\*9. Type of Applicant 1: Select Applicant Type:**

B.County Government

Type of Applicant 2: Select Applicant Type:

Type of Applicant 3: Select Applicant Type:

\*Other (Specify)

**\*10 Name of Federal Agency:**

U.S. Department of Housing and Urban Development

**11. Catalog of Federal Domestic Assistance Number:**

14.239

CFDA Title:

HOME Investment Partnerships Program

**\*12 Funding Opportunity Number:**

\*Title:

**13. Competition Identification Number:**

Title:

**14. Areas Affected by Project (Cities, Counties, States, etc.):**

Marin County, California

**\*15. Descriptive Title of Applicant's Project:**

HOME Investment Partnerships Program  
Program Year 2012-13  
Federal Fiscal Year 2012

HOME

<b>Application for Federal Assistance SF-424</b>		Version 02
<b>16. Congressional Districts Of:</b>		
*a. Applicant: CA-006	*b. Program/Project: CA-006	
<b>17. Proposed Project:</b>		
*a. Start Date: July 1, 2012	*b. End Date: June 30, 2013	
<b>18. Estimated Funding (\$):</b>		
*a. Federal	\$595,350	_____
*b. Applicant	_____	_____
*c. State	_____	_____
*d. Local	→ 150,000	_____
*e. Other	_____	_____
*f. Program Income	→ 5,000	_____
*g. TOTAL	\$750,350	_____
<b>*19. Is Application Subject to Review By State Under Executive Order 12372 Process?</b>		
<input type="checkbox"/> a. This application was made available to the State under the Executive Order 12372 Process for review on _____		
<input type="checkbox"/> b. Program is subject to E.O. 12372 but has not been selected by the State for review.		
<input checked="" type="checkbox"/> c. Program is not covered by E. O. 12372		
<b>*20. Is the Applicant Delinquent On Any Federal Debt? (If "Yes", provide explanation.)</b>		
<input type="checkbox"/> Yes <input checked="" type="checkbox"/> No		
21. *By signing this application, I certify (1) to the statements contained in the list of certifications** and (2) that the statements herein are true, complete and accurate to the best of my knowledge. I also provide the required assurances** and agree to comply with any resulting terms if I accept an award. I am aware that any false, fictitious, or fraudulent statements or claims may subject me to criminal, civil, or administrative penalties. (U. S. Code, Title 218, Section 1001)		
<input checked="" type="checkbox"/> ** I AGREE		
** The list of certifications and assurances, or an internet site where you may obtain this list, is contained in the announcement or agency specific instructions		
<b>Authorized Representative:</b>		
Prefix: _____	*First Name: <u>Matthew</u> _____	
Middle Name: _____		
*Last Name: <u>Hymel</u> _____		
Suffix: _____		
*Title: County Administrator		
*Telephone Number: (415) 473-6358	Fax Number: (415) 473-4104	
* Email: mhymel@marincounty.org		
*Signature of Authorized Representative:	*Date Signed: May 9, 2012	

**Application for Federal Assistance SF-424**

Version 02

**\*Applicant Federal Debt Delinquency Explanation**

The following should contain an explanation if the Applicant organization is delinquent of any Federal Debt.

## **Executive Summary**

In its use of Community Development Block Grant (CDBG) and HOME Investment Partnerships Program (HOME) funds, Marin County has four major emphases:

- Expanding the supply of affordable housing (with outcomes to be measured by the number of units produced),
- Accessibility improvements for people with disabilities for public facilities in the City of San Rafael (with outcomes to be measured by the number of public facilities improved),
- Preserving the existing supply of affordable housing (with outcomes to be measured by the number of units rehabilitated), and
- A variety of public services which will assist seniors, persons with disabilities, youth, single-parent families, and the working poor (with outcomes to be measured by the number of persons assisted).

This year, the HOME Program is funding three housing development projects, Housing for Working Families (Homeward Bound of Marin), Inverness Valley Inn Housing (Community Land Trust Association of West Marin), and Marinwood Plaza (BRIDGE Housing Corporation).

Marin County is an extremely high-cost housing market, and there continues to be a serious shortage of affordable housing in Marin County for low-income workers, people with disabilities, and seniors. Each year, we make a little bit of progress in building affordable housing, and we plan to continue that progress by continuing to build more affordable rental housing. Because Marin County is an extremely high-cost housing market, with a very high cost of land, and where most vacant developable parcels have significant site engineering issues, we expect that the per-unit costs of rental housing development will continue to be extremely high. There is increasing support for “green” affordable housing development from environmental activists, who recognize the spillover effects of the air pollution caused by long commutes to Marin. We are fortunate to have active non-profit housing development organizations with a strong sense of social conscience and the entrepreneurial skills to be capable of building housing under difficult economic conditions.

**MARIN COUNTY CONSOLIDATED PLAN AMENDMENTS**  
**AND ACTION PLAN FOR FISCAL YEAR 2012**

**Action Plan for Fiscal Year 2012**

The Marin County Consolidated Plan presents a vision for housing and community development. In 2010, the County of Marin adopted a five-year Consolidated Plan covering Fiscal Years 2010-2014. The Consolidated Plan, as amended, is Marin County's Housing Assistance Plan. Each year, the County adopts an amendment to update the five-year Consolidated Plan. The Fiscal Year 2012 amendment to the Consolidated Plan includes a One-Year Action Plan for spending:

- \$1,166,041 in Fiscal Year 2012 Community Development Block Grant (CDBG) funds,
- \$595,350 in Fiscal Year 2012 HOME Investment Partnerships Program (HOME) funds,
- \$403,522 in CDBG reprogrammed funds,
- \$163,250 in HOME reprogrammed funds,
- an estimated \$453,860 in CDBG program income, and
- \$5,000 in HOME program income.

Marin County's share of the regional Housing Opportunities for Persons with AIDS Program (HOPWA) formula allocation is received via the San Francisco Redevelopment Agency, and is therefore included in San Francisco's Consolidated Plan. For informational purposes only, a copy of the proposed HOPWA budget is included here.

Please note that Fiscal Year 2012 CDBG, HOME, and HOPWA funds come from the federal budget that covers the period October 1, 2011 to September 30, 2012, but are used locally for the program year that runs from July 1, 2012 to June 30, 2013.

The CDBG, HOME, and HOPWA grant amounts in this Action Plan are estimates. After we are notified of our exact CDBG, HOME, and HOPWA allocations, we will revise the project-by-project grant amounts accordingly.

The CDBG, HOME, and HOPWA funds will be spent on housing, capital, and public service activities. The Action Plan presents the budget for the use of Federal Fiscal Year 2012 CDBG and HOME funds, presented in the form of a list of proposed activities to be undertaken during the program year that runs from July 1, 2012 to June 30, 2013 to address local priority needs. *Priority needs are detailed in Section 91.215(b) of the 2010-2014 Consolidated Plan, and the priority needs have not changed in the past year.*

## 91.105 and 91.200 Citizen Participation

### Citizen Participation Plan

#### Applicability

This revised plan provides for and encourages citizen participation in the development of the County's application to the U.S. Department of Housing and Urban Development (HUD) for Community Development Block Grant, HOME, and other federal housing programs, and in the development of the County's Consolidated Plan. The Consolidated Plan details housing and non-housing community development needs, identifies federal funds available to the County, and lists the projected use of these funds. This plan also provides for citizen involvement in the amending of previous years' applications, in reprogramming, and in evaluating program and project performance.

This revised plan is designed especially to encourage participation by low and moderate income persons residing near where federal community development funds are proposed to be used, and by residents of predominantly low and moderate income neighborhoods, particularly those who are disabled, racial and ethnic minorities, and single parent householders living in areas where Federal funds are most likely to be spent.

#### Policy

A. All residents will be encouraged to:

1. Participate in all phases of the project selection process.
2. Articulate needs.
3. Assist in establishing goals and strategies appropriate to meeting such goals.
4. Express preferences about proposed activities.
5. Assist in the selection of priorities.
6. Evaluate program and project performance.
7. Participate in the development of federal assistance program applications, any program amendments to them, the Consolidated Plan, any substantial amendments to the Plan, and performance reports.
8. Have reasonable and timely access to local meetings, information, and records relating to both the proposed and actual use of federal housing and community development funds, in compliance with all regulations.

## Plan

To implement this policy, the County of Marin will encourage citizen participation at several levels as follows:

### I. Citizen Participation/Planning Areas

- A. Six interjurisdictional planning/citizen participation areas have been established, encompassing both participating incorporated cities and adjacent unincorporated areas. These subregional areas are designated to provide manageable planning units and support the concept of a community of interest. The areas are:
1. Novato Planning Area (includes Novato, Ignacio, Bel Marin Keys, and Black Point)
  2. San Rafael Planning Area (includes San Rafael, Los Ranchitos, Lucas Valley, Marinwood, and Santa Venetia)
  3. Upper Ross Valley (includes Fairfax, Ross, and San Anselmo)
  4. Lower Ross Valley (includes Corte Madera, Larkspur, Kentfield, Greenbrae, and San Quentin)
  5. Richardson Bay (includes Belvedere, Mill Valley, Sausalito, Tiburon, Marin City, Strawberry, Tam Valley, and Waldo Point)
  6. West Marin, encompassing the inland rural and coastal corridors.
- B. To solicit public input, an annual informational workshop for citizens, public agencies, and other interested parties shall be held prior to the County adopting the Consolidated Plan to:
1. Review the amount of funds and program income expected to be received by the County and to be available to each planning area for community development and/or housing purposes, the kinds of activities previously funded with federal funds, a proposed schedule of upcoming meetings and hearings, the range of activities that may be undertaken with available funds, and the estimated amount that will benefit low and moderate income persons. Information about plans to minimize the displacement of persons and to assist persons displaced as a result of federal housing program activities will also be made available. Information regarding assistance the County will provide to displaced persons will be made available in written form in accordance with the County's displacement policies. Interested parties will be provided with reasonable and timely access to local meetings.
  2. Assess housing and community development needs and determine goals and strategies.

3. Discuss potential community development projects and recommend priorities and alternatives for funding.
  4. Review program requirements, such as environmental policies, equal opportunity, labor standards, citizen participation, relocation provisions and contracting procedures.
  5. Establish needs for new and existing assisted housing.
  6. Identify potential target areas for housing rehabilitation and other community development assistance.
- C. The County, working closely with city staff, the County Supervisor(s), and the Priority Setting Committee members from each subarea, shall establish meeting agendas, meeting dates, and locations.
- D. The Priority Setting Committee members and city and county staffs shall keep the City Councils and the Board of Supervisors fully informed and involved in the area planning process, with the clear understanding that the cities and county have jurisdiction over land use issues within their boundaries.
- E. Local Area Committees and/or the Priority Setting Committee shall hear proposals for the reallocation of Community Development Block Grant funds from existing approved projects within each Planning Area. Minor reallocations may go directly to the Board of Supervisors for approval. Project sponsors of existing projects will be notified in writing at least 30 days in advance of a hearing at which reallocation of funds from a project will be considered.

## II. Countywide Priority Setting Committee

- A. The Countywide Priority Setting Committee shall consist of one representative of the Council of each participating city or town, additional members representing racial and ethnic minorities and people with disabilities, and a member of the Marin County Board of Supervisors. The Committee shall provide detailed involvement in housing and community development activities for the representatives selected by the participating entities. The role of the Committee will encompass the following responsibilities, and any other activities deemed appropriate by the Board of Supervisors:
1. Hold at least one annual countywide public hearing during the development of the Consolidated Plan to obtain citizen comments on housing and community development needs, development of proposed programs, and review of program performance. Each hearing shall be held after adequate notice is given and at times and locations convenient to potential or actual beneficiaries, and with accommodation to persons with disabilities.



2. Review the amount of funds available to the County as a whole for community development and housing activities.
3. Assess needs and determine goals and strategy for the County as a whole, incorporating the materials developed by the citizen participation/planning areas.
4. Coordinate community development projects and funding priorities.
5. Be informed of program requirements, including environmental policies, equal opportunity, labor standards, relocation, and acquisition provisions.
6. Consider proposals for new and existing assisted housing on a countywide basis and evaluate competing proposals for funding.
7. Participate in the subregional workshops and hearings and serve as liaison from the community meetings to the respective Councils.
8. Keep respective City and Town Councils fully apprised of all Committee actions and request ratification of major policy and program issues, as needed. Town or City Council consensus on each Committee action is not required.
9. Recommend reallocation of funds from lagging or ineligible activities, by designating new activities or locations, and by recommending program or policy changes to the Board of Supervisors for final action.
10. Consolidate the subregional programs into a comprehensive Countywide package for community development and housing, for referral to the Board of Supervisors, ensuring that the program presented is consistent with HUD guidelines and appropriate to meeting identified needs.
11. Recommend approval or modification of the methodology of community development and housing project selection and of the citizen participation plan.
12. Set annual funding and policy for local housing assistance program. Monitor program progress and performance.
13. Have an oversight role for the Implementation Plan for the Analysis of Impediments to Fair Housing Choice. The Priority Setting Committee will track actions localities take to affirmatively further fair housing, and will lead a process of peer evaluation of each community's efforts to affirmatively further fair housing.

- B. Periodic meetings shall be scheduled with a minimum of one annual public hearing at which citizens may examine and comment on the County's proposed statement of community development objectives and projected use of funds.

III. Local Area Committees

- A. For each Planning Area, the Local Area Committee shall consist of all the city and town council appointees to the Priority Setting Committee from the cities and towns in the Planning Area, non-elected community representative(s) of protected classes (racial and ethnic minorities and people with disabilities), plus a County Supervisor whose supervisorial district most closely coincides with the Planning Area. Each Local Area Committee shall:

1. Hold at least one annual public hearing during the development of the Consolidated Plan to obtain citizen comments on housing and community development needs, development of proposed needs, and review of program performance. Each hearing shall be held after adequate notice is given and at times and locations convenient to potential or actual beneficiaries, and with accommodation for persons with disabilities. Planning Area hearings shall be held before the proposed Consolidated Plan is published for comment.
2. Review the amount of funds available to the Planning Area for community development and housing activities.
3. Be informed of program requirements, including environmental policies, equal opportunity, labor standards, relocation, and acquisition provisions.
4. Consider proposals for new and existing assisted housing, capital, and public service projects to benefit residents within its Planning Area.
5. Keep respective City and Town Councils fully apprised of all Local Area Committee actions.
6. Recommend reallocation of funds from lagging or ineligible activities, by designating new activities or locations, and by recommending program or policy changes to the Priority Setting Committee.
7. Recommend allocation of Planning Area funds for specific community development and housing projects, for referral to the Priority Setting Committee, ensuring that the projects presented are consistent with HUD guidelines and appropriate to meeting identified needs.

- B. For any CDBG Planning Area which includes a city with a population of 50,000 or more (according to population estimates issued by the U.S. Department of Housing and Urban Development), the system described above for allocation of CDBG funds in that Planning Area will, at the option of the largest city in the Planning Area, be modified as follows:

The City Council of the largest city in the Planning Area, rather than the Local Area Committee (consisting of one representative designated by the Board of Supervisors, one representative designated by each of the participating cities located within the planning area, and non-elected representatives of protected classes), will prepare the proposed list of projects for the use of (a) that Planning Area's funds, and (b) that Planning Area's "proportional share" of CDBG Countywide Housing funds. "Proportional share" shall be defined as the same proportion by which Planning Area funds are distributed among the Planning Areas. The City Council will establish its own system for setting local funding priorities, but its process for selecting projects must include a public hearing. The City Council must consider the needs of all eligible persons who reside within the planning area, including those outside city limits, but will not be subject to any quotas with regard to the type or location of projects. The Priority Setting Committee will recommend allocation of HOME funds on a countywide basis, but may restrict the CDBG Countywide Housing funds remaining under its jurisdiction to planning areas not implementing the provisions of this paragraph.

#### IV. City Councils

City Councils shall be involved in the program through endorsement of major policy issues, through the workshop and subregional hearing process, through cooperation agreements, and through their representatives on the Priority Setting Committee.

#### V. Board of Supervisors

- A. The Board of Supervisors, as the sole responsible agent to HUD, shall be involved individually in the area hearings, by representation on the Priority Setting Committee, and by reviewing and approving the Consolidated Plan before it is submitted to HUD.
- B. The Board of Supervisors shall conduct at least one public hearing each year on the Consolidated Plan and the proposed use of federal housing and community development funds.
- C. The Board of Supervisors shall conduct a minimum of one public hearing whenever the policies of the Consolidated Plan vary significantly from housing and community development policies previously approved.

#### VI. Outreach

##### A. Consolidated Plan

- 1. The County will develop the Consolidated Plan which details housing and non-housing community development needs in Marin County. The Consolidated Plan will identify available federal funds available and the projected use for these funds.

2. The County will publish a notice of availability of the proposed Consolidated Plan in the Marin Independent Journal, a local newspaper of general circulation, and make copies of the proposed plan available upon request. The proposed plan shall be available for not less than 30 days to allow for public comment on the plan prior to a public hearing on the plan held by the Board of Supervisors. Once adopted, the County shall make the Consolidated Plan, any amendments to the Consolidated Plan, and any performance reports available to the public. Marin County will provide a reasonable number of free copies of the plan to citizens and groups requesting it.
3. The County will consider any comments or views of citizens received in writing, or orally in preparing the final Consolidated Plan. Interested parties will be given at least 30 days to comment on the Consolidated Plan. A summary of comments or views either accepted or not accepted, and the rationale, will be included.
4. The County of Marin will amend the Consolidated Plan whenever it decides to carry out an activity not previously described in the Consolidated Plan, or to substantially change the purpose, scope, location, or beneficiaries of an activity. If the funding level for an activity changes by no more than 10%, then the change will not be considered substantial. If the location of an activity is described in the Consolidated Plan as "to be determined," "to be selected," "community wide," "citywide," "countywide," or similar terms, then the selection of a site will not be considered to be a substantial change. A change in scope or beneficiaries will be considered substantial if the change affects the eligibility of the project for the intended HUD funding program.
5. The County of Marin will amend the Consolidated Plan whenever it: 1) decides to make a change in its allocation priorities or a change in the method of distributing funds, 2) decides to carry out an activity not previously described in the Action Plan, using funds from any program covered by the Consolidated Plan (including program income), 3) decides to change the purpose, scope, location, or beneficiaries of an activity, or 4) reprograms funds by transferring an allocation from one project to one or more projects. If the funding level for an activity changes by no more than 10%, then the change will not be considered substantial. If the location of an activity is described in the Consolidated Plan as "to be determined," "to be selected," "community wide," "citywide," "countywide," or similar terms, then the selection of a site will not be considered to be a substantial change. A change in scope or beneficiaries will be considered substantial if the change affects the eligibility of the project for the intended HUD funding program.
6. The County will publish a notice to amend the Consolidated Plan in the Marin Independent Journal, a local newspaper of general circulation, when a proposed amendment is substantial. The County will provide not less

than 30 days to allow for public comment on the amendment prior to a public hearing on the amendment held by the Board of Supervisors. Marin County will ensure that all notices of public hearings inform persons with vision impairments of the availability of records in alternate formats, upon request; and will include, for persons with hearing impairments, a telephone contact number of the person responsible for receiving requests for the provision of reasonable accommodations during the CDBG citizen participation process.

7. The County will consider any comments or views of citizens received in writing, or orally, in preparing the Consolidated Plan performance report. Once the performance report is drafted, a notice will be published in the Marin Independent Journal giving interested parties 15 days to comment on the performance report that is to be submitted to HUD. A summary of these comments or views, an indication of whether they are either accepted or not accepted, and the rationale for acceptance or rejection, will be attached to the performance report.
- B. News media will be informed of all meetings.
  - C. Summary community profiles of selected census tracts and/or smaller neighborhood areas will be made available. These neighborhood analyses will identify concentrations of lower income households.
  - D. County staff will seek out and respond to project ideas, comments, and inquiries, and will encourage participation by lower income persons, residents of lower income neighborhoods, lower income residents of slum and blighted areas, lower income residents of areas in which funds are proposed to be used, individuals and organizations which are currently serving the needs of lower income persons, and all other persons. Staff will provide appropriate technical assistance to groups representing lower income people in developing project proposals. Assistance in developing project ideas and realistic project budgets will be provided. Use of funds and timing of each application process will be explained. Staff will provide responses to written proposals prior to the final hearing for each housing assistance program.
  - E. All public hearings will be noticed at least two weeks in advance of the hearing with notices indicating the date, time, place and procedures of the hearing and the topics to be considered, and each hearing will provide program information, review program status, and provide a forum for public input, questions, and project requests. All hearing locations shall be accessible to persons with disabilities. Staff will take necessary actions to encourage participation by people with special needs.
  - F. County staff will provide appropriate technical assistance to all citizens and project sponsors who request assistance in developing funding proposals for funding assistance under any of the programs covered by the Consolidated Plan.

- G. Staff will make all program information fully available to the public.
- H. Staff will make available for citizen review during normal working hours at the Marin County Community Development Agency office the following program documents: all mailings and promotional material, records of hearings, all prior applications, all letters of approval, all grant agreements, records regarding the past use of funds, all performance reports, all evaluation reports, and other reports required by HUD, including the citizen participation plan, the proposed and approved statements of community development objectives and projected use of funds, copies of the regulations and issuances governing the program, and documents regarding other important program requirements such as contracting procedures, environmental policies, fair housing and other equal opportunity requirements and relocation provisions.
- I. Staff will encourage the participation of all persons including those with disabilities including mobility, visual, or hearing impairments.
- J. Staff will encourage the participation of non-English speaking residents and identify how their needs can be met, and when a significant number of non-English speaking residents can reasonably be expected to participate in a public hearing, to make arrangements for their full participation, including provision of translators.
- K. Staff will encourage, in conjunction with the Marin County Housing Authority, the participation of residents of public and assisted housing developments in the process of developing and implementing the Consolidated Plan, along with other low income residents throughout the County. The County will provide information to the Housing Authority about projects identified in the Consolidated Plan related to Housing Authority developments and surrounding communities so that the Housing Authority can make this information available at the annual public hearing required under the Comprehensive Grant Program.
- L. The County will provide residents with a reasonable opportunity to comment on the original citizen participation plan and on substantial amendments to the citizen participation plan. If requested, the citizen participation plan shall be made available in a format accessible to people with disabilities.

## VII. Performance

- A. The grantee's performance will be reviewed at Planning Area and Countywide public hearings. (See Part I.)
- B. Copies of all reporting documents submitted to HUD will be available to interested parties upon request.

## VIII. Citizen Participation

Copies of this Citizen Participation Plan, the Consolidated Plan, as adopted, substantial amendments to the Consolidated Plan, and performance reports, shall be made available to interested private individuals, associations, public organizations, and participating communities upon request. If requested, these materials shall be made available in a format accessible to persons with disabilities.

## IX. Grievance Mechanism

Staff will provide written responses to written complaints and grievances within 15 days of receipt, where practicable. If the complaint is not resolved at a staff level, the Priority Setting Committee shall serve as a first appeal level. If a grievance is not resolved at that level, it may be appealed to the Board of Supervisors, whose decision shall be final. Citizens will also be notified of the opportunity to submit views and criticisms to the HUD Area Office.

## X. Displacement Policy

- A. It is the policy of Marin County to minimize the displacement of persons as a result of community development activities. It is the policy of Marin County to, whenever possible, avoid using HUD funds to undertake or support activities which would result in involuntary displacement of persons from their homes and neighborhoods. In its evaluation of project proposals, Marin County will give substantially lower priority to projects which will cause involuntary residential displacement or which will cause rents to rise so as to cause involuntary economic displacement of residential tenants. In all cases, Marin County will carefully weigh the benefits of a proposed project against any hardship it might impose on those potentially displaced, giving special consideration to the shortage of low-priced rental housing in Marin County.
- B. It is the policy of Marin County to assist persons actually displaced by community development activities. It is the policy of Marin County to mitigate the adverse effects of any involuntary permanent residential displacement caused by HUD-supported activities, with particular concern for low and moderate income persons. If involuntary permanent residential displacement occurs as a result of HUD-supported activities, Marin County will attempt to assist displaced persons to relocate within their own neighborhoods or in newly constructed or substantially rehabilitated publicly assisted housing. Marin County will provide for reasonable benefits to any person involuntarily and permanently displaced as a result of the use of HUD funds to acquire or substantially rehabilitate property. This assistance may take the form of technical assistance and/or financial assistance, depending on the circumstances. In any case where the HUD regulations require the County to provide relocation assistance or follow particular relocation procedures, Marin County will comply with these requirements. In any case where the Uniform Relocation Assistance and Real Property Acquisition Policies Act of 1970 (as amended) requires the County to provide relocation assistance or follow particular relocation procedures, Marin County will comply with these requirements.

### Development of the Annual Plan

In developing the Consolidated Plan, Marin County consulted with units of local government on housing and non-housing community development needs in Marin County. In developing the amendments, the County staff consulted with housing providers and non-profit social service providers and with local governments where proposed projects would be located.

### Citizen Participation Process

Copies of the amended Consolidated Plan were made available to interested persons, associations, public organizations, and participating communities upon request. The Plan was developed by the Marin County Community Development Agency, after consultation with adjacent units of government, affordable housing advocates, nonprofit housing developers, public and nonprofit social service providers, and staffs of Marin County governmental departments. On September 20, 2011, and on March 29, 2012, public hearings were held to solicit public comment on the housing and priority non-housing community development needs of extremely low, very low, low, and moderate income persons for inclusion in the amended Consolidated Plan. An additional public hearing to solicit comment on these same issues was held on May 8, 2012. In addition to the three hearings on housing and non-housing community development needs, seven public hearings were held to solicit comments on the proposed use of CDBG funds in six geographical areas of Marin County. On March 23, 2012, a notice was published in the Marin Independent Journal announcing that the draft Fiscal Year 2012 amendment to the Consolidated Plan would be available for a 30-day public review. No public comments were received.

On September 12, 2011, the CDBG Countywide Priority Setting Committee approved an Analysis of Impediments to Fair Housing Choice (AI), including an Implementation Plan that sets out a variety of actions intended to improve the County's performance on fair housing issues in Marin. The AI (including the Implementation Plan) was approved by the Marin County Board of Supervisors on October 11, 2011. One of the recommendations in the AI was the expansion of the CDBG Priority Setting Committee to add representatives of racial and ethnic minorities and people with disabilities.

At its February 16, 2012 meeting, the CDBG Countywide Priority Setting Committee added six non-elected community members representing racial and ethnic minorities and people with disabilities.

### Description of the Lead Agency

The Federal Grants Division is a small office within the Marin County Community Development Agency which is responsible for the development of the Consolidated Plan and the administration of federal housing and community development grants.

### **91.220(a) Application For Federal Assistance (Standard Form 424)**

The Applications for Federal Assistance (Standard Form 424) are located at the beginning of this plan.



**91.220(b) (including 91.220(b)(1) and (b)(2))      Resources**

Anticipated annual CDBG funding	\$1,166,041
Anticipated annual HOME funding	\$595,350

Marin County also expects to receive additional funding from the following sources:

<b>Federal</b>
Shelter Plus Care Program
Section 8 Rental Vouchers
Veterans Administration Supportive Housing Vouchers
Housing Opportunities for Persons with AIDS (HOPWA)
Capital Fund (Public Housing)
Senior/Disabled Public Housing operating fund
Marin City Public Housing operating fund
Section 8 Substantial Rehabilitation HAP – Bradley House
Resident Opportunities For Self-Sufficiency (ROSS)
Family Self-Sufficiency
Section 8 Homeownership

<b>Local</b>
Shelter Plus Care (CMHS)
Rebate for Marin Renters-Housing Stability Program
Below-Market Rate Sales Program (11 local jurisdictions)
Family Self-Sufficiency (Marin City Public Housing)

Nonprofit agencies in Marin County receive a limited portion of their funding from governmental assistance. They also receive substantial foundation grants. The following are resources expected to be received directly by nonprofit agencies in Marin County during the 2012-13 program year (July 1, 2012-June 30, 2013) for their housing and community development activities:

<b>Private</b>
Marin Community Foundation (grants for housing and community development)
Other Private Foundations

The HOME Program matching funds obligation will be met primarily by leveraging funds from the Marin Community Foundation, the Affordable Housing Program (AHP), state government programs, private donors, and other foundations, and by obtaining credit for waivers of local fees.

**91.220(c)      Activities to be Undertaken**

The following pages list the budget for the use of CDBG and HOME funds for the period July 1, 2012 through June 30, 2013. New Fiscal Year 2012 funds, reprogrammed funds, and program income are included. This section provides a list of proposed activities to be undertaken during

the next program year to address local priority needs. The number and type of families that will benefit from the proposed activities are indicated. Questions regarding specific activities may be addressed by contacting the Marin County Community Development Agency, Federal Grants Division office at 473-6695.

All the listed Community Development Block Grant projects meet the National Objective of low and moderate income benefit. None of the projects meet the two other National Objectives, "urgent needs" and "slums and blight."

References to the Novato Planning Area, San Rafael Planning Area, Lower Ross Valley Planning Area, Upper Ross Valley Planning Area, Richardson Bay Planning Area, West Marin Planning Area, and Countywide Housing Funds are intended to refer to Community Development Block Grant funds which are locally distributed through those designations. The source of budgeted funds is designated with the following codes:

Countywide	Countywide Housing component of CDBG
HOME	HOME Program
Lower Ross Valley	Lower Ross Valley Planning Area component of CDBG
Novato	Novato Planning Area component of CDBG
Richardson Bay	Richardson Bay Planning Area component of CDBG
San Rafael	San Rafael Planning Area component of CDBG
Upper Ross Valley	Upper Ross Valley Planning Area component of CDBG
West Marin	West Marin Planning Area component of CDBG

**CDBG and HOME Projects - 2012-13  
Project Descriptions**

PROJECT NAME	PROJECT SPONSOR	PROJECT ADDRESS	DESCRIPTION
After School Transportation Program	Fairfax-San Anselmo Children's Center	199 Porteous Avenue, Fairfax 94930	Staff salaries
Fair Housing Services	Fair Housing of Marin	615 B Street, Suite #1, San Rafael 94901 30 North San Pedro Road, Suite 245, San Rafael 94903	Fair housing services
Family Law Legal Services	Family & Children's Law Center	5520 Nave Drive (94949), 1320 Lynwood Drive (94947), Novato	Legal assistance for low income families
Family Outreach Project	Marin Head Start (Community Action Marin)	300 Napa Street, Sausalito 94965	Family outreach services
Galilee Harbor-rehabilitation	Galilee Harbor Community Association		Public improvements for liveaboard community Purchase and install two sheds, fencing, etc. for affordable housing
Gibson House-storage shed	Bolinas Community Land Trust	20 Wharf Road, Bolinas 94924	
Hamilton Child Center-Rehabilitation	Community Action Marin	531 Hamilton Parkway, Novato 94949	Child care center-roof replacement
Home Care Assistance for the Elderly	West Marin Senior Services	11435 State Route 1, Creamery Annex, Point Reyes Station 94956	Home care referrals and assistance for the elderly and disabled
Housing for Working Families	Homeward Bound of Marin	5394 Nave Drive, Novato 94949	Development of affordable housing (rehabilitation and offsite improvements)
Housing Search Specialist	Marin Housing Authority	4020 Civic Center Drive, San Rafael 94903	Staff salary for housing search specialist
Human Services Program	San Geronimo Valley Community Center	6350 Sir Francis Drake Blvd., San Geronimo 94963	Staff salaries for center programs
Inverness Valley Inn Housing	Community Land Trust Association of West Marin	13275 Sir Francis Drake Blvd., Inverness 94937	Acquisition and rehabilitation of affordable housing
Lifehouse: San Anselmo House-rehabilitation	Lifehouse Inc.	1036 Sir Francis Drake Blvd., San Anselmo 94960	Rehabilitate group home-roof
Lifehouse: Sunrise I-rehabilitation	Lifehouse Inc.	627 Wilson Avenue, Novato 94947	Rehabilitate group home-kitchen
Marin Brain Injury Network Services	Marin Brain Injury Network	1132 Magnolia Avenue, Larkspur 94939	Staff salaries for services for head injury survivors
Marin City CDC-office rehabilitation	Marin City Community Development Corp.	441 Drake Avenue, Marin City 94965	ADA and safety repairs to building exterior
Marin Learning Center, Therapeutic Services	Community Action Marin	100 Phillips Drive, Marin City 94965	Therapeutic services for children
Marinwood Plaza Housing	BRIDGE Housing Corp.	121, 155, 175, 197 Marinwood Avenue, San Rafael 94903	Development of affordable housing (site acquisition and offsite improvements)
Middle School Program	Canal Alliance	91 Larkspur Street, San Rafael 94901	Staff salaries for after school and summer
North Bay Children's Center Scholarships	North Bay Children's Center	932 C Street, Novato 94949	Child care scholarships
North Bay Children's Center-Rehabilitation	North Bay Children's Center	932 C Street, Novato 94949	Rehabilitation of building and play yard
Novato Independent Elders Program	Episcopal Senior Communities	1560 Hill Road, Novato 94947	Senior services
Novato Youth Center Scholarships	Novato Youth Center	680 Wilson Avenue, Novato 94947	Child care scholarships
Performing Stars	Performing Stars of Marin	271 Drake Avenue, Marin City 94965	Social/self development for low income children
Pickleweed Children's Center	City of San Rafael	40 Canal Street, San Rafael, CA 94901 629 Plum Street (94945), 1320 Lynwood Drive (94947), Novato	Staff salaries for child care
Quality Care for Kids Scholarships	Quality Care for Kids		Child care scholarships
Rehabilitation Loan Program	Marin Housing Authority	4020 Civic Center Drive, San Rafael 94903	Staff salaries to provide residential rehabilitation loans

**CDBG and HOME Projects - 2012-13**  
**Project Descriptions**

PROJECT NAME	PROJECT SPONSOR	PROJECT ADDRESS	DESCRIPTION
Residential Accessibility Modification Program	Marin Center for Independent Living		Housing rehabilitation for handicapped accessibility
San Rafael ADA Compliance	City of San Rafael	Countywide	
Senior Access Scholarships	Senior Access	Citywide	Accessibility improvements for public facilities
Tomales Town Hall-Rehabilitation	Tomales Town Hall	70 Skyview Terrace, Bldg. B, San Rafael	Scholarships, elderly day care
		27150 Shoreline Hwy., Tomales 94971	Rehabilitate community center
CDBG Administration	County of Marin	3501 Civic Center Drive and 899 Northgate Drive, San Rafael 94903	
HOME Program Administration	County of Marin	3501 Civic Center Drive and 899 Northgate Drive, San Rafael 94903	



**CDBG and HOME Projects - 2012-13**  
**Summary of Objectives and Outcomes**

PROJECT NAME	EXPECTED COMPLETION DATE	OBJECTIVE CATEGORY	OUTCOME CATEGORIES	PRIORITY NEED CATEGORY	EXPLANATION	SPECIFIC OBJECTIVE	HOMELESS OR SPECIAL NEEDS	ACCOMPLISHMENT TYPE	PROPOSED	PROPOSED OUTCOME	PERFORMANCE MEASURE	MATRIX CODES
After School Transportation Program	6/30/2013	2	1	PS	2	K		01	60	60 persons served	Number of persons served	05D Youth Services 570.201e
Fair Housing Services	6/30/2013	2	1	PS	2	C,K		01	350	350 persons served	Number of persons served	05J Fair Housing Activities (if CDBG, then subject to 570.201e)
Family Law Legal Services	6/30/2013	2	1	PS	2	K		01	50	50 persons served	Number of persons served	05C Legal Services 570.201e
Family Outreach Project	6/30/2013	2	1	PS	2	K		01	200	Provide 200 families with support services	Number receiving family support services	05D Youth Services 570.201e
Galilee Harbor-rehabilitation	6/30/2015	2	1	PF	1	M		11	1	1 public facility improvement	Number of public facility improvements	03E Neighborhood Facilities 570.201c
Gibson House-storage shed	6/30/2013	1	1	RH	4	B		10	7	Exterior rehabilitation of 7 units	Rehabilitation of 7 units	14B Rehabilitation: Multi-Unit Residential 570.202
Hamilton Child Center-Rehabilitation	6/30/2013	2	2	PF	4	M		11	40	Rehabilitation of one child care center	Rehabilitation of child care center	03M Child Care Centers 570.201c
Home Care Assistance for the Elderly	6/30/2013	2	1	PS	2	K	✓	01	10	Home care assistance for 10 seniors	Number of persons assisted	05A Senior Services 570.201e
Housing for Working Families	12/30/2015	1	1	RH	1,4	A,C		10	15	Development and rehabilitation of buildings for affordable housing	Housing units	14B Rehabilitation: Multi-Unit Residential 570.202; 03 Public Facilities (off-site improvements) 570.201c
Housing Search Specialist	6/30/2013	1	1	PS	2,3	C	✓	01	50	50 persons served	Number of persons served	05K Tenant/Landlord Counseling 570.201e
Human Services Program	6/30/2013	2	1	PS	2	K		1	200	200 persons assisted	Number of persons assisted	05W Food Bank 570.201e
Inverness Valley Inn Housing	12/30/2015	1	2	RH	4	A,C		10	20	Acquisition, rehabilitation of buildings for affordable housing	Acquisition and rehabilitation of affordable housing	14B Rehabilitation: Multi-Unit Residential 570.202; 01 Acquisition of Real Property 570.201a
Lifehouse: San Anselmo House-rehabilitation	6/30/2013	1	3	PF	4	F	✓	11	1	Rehabilitation of one group home	Rehabilitation of group home	03B Handicapped Centers 570.201c
Lifehouse: Sunrise I-rehabilitation	6/30/2013	1	3	PF	4	F	✓	11	1	Rehabilitation of one group home	Rehabilitation of group home	03B Handicapped Centers 570.201c
Marin Brain Injury Network Services	6/30/2013	2	1	NSN	2	K	✓	01	20	20 persons served	Number of persons served	05B Handicapped Services 570.201e
Marin City CDC-office rehab	6/30/2013	2	1	PF	4	M	✓	11	1	Rehabilitation of one facility	Rehabilitation of one facility	03E Neighborhood Facilities 570.201c
Marin Learning Center, Therapeutic Services	6/30/2013	2	1	PS	1	K	✓	01	8	8 children assisted	Number of children assisted	05D Youth Services 570.201e
Marinwood Plaza Housing	12/30/2015	1	2	RH	1	A,C		10	60	Develop 60 units of affordable housing	Development of affordable housing units	01 Acquisition of Real Property 570.201a; 03 Public Facilities (off-site improvements) 570.201c
Middle School Program	6/30/2013	2	1	PS	2	K		01	30	30 youths assisted	Number of youths assisted	05D Youth Services 570.201e
North Bay Children's Center Scholarships	6/30/2013	2	1	PS	2	K		01	4	4 children served	Number of children served	05L Child Care Services 570.201e
North Bay Children's Center-Rehabilitation	6/30/2013	2	1	PF	1	M		11	1	Rehabilitation of one child care center	Rehabilitation of child care center	03M Child Care Centers 570.201c
Novato Independent Elders Program	6/30/2013	2	1	PS	1	K	✓	01	1000	1,000 persons served	Number of persons served	05A Senior Services 570.201e

**CDBG and HOME Projects - 2012-13  
Summary of Objectives and Outcomes**

PROJECT NAME	EXPECTED COMPLETION DATE	OBJECTIVE CATEGORY	OUTCOME CATEGORIES	PRIORITY NEED CATEGORY	EXPLANATION	SPECIFIC OBJECTIVE	HOMELESS OR SPECIAL NEEDS	ACCOMPLISHMENT TYPE	PROPOSED	PROPOSED OUTCOME	PERFORMANCE MEASURE	MATRIX CODES
Novato Youth Center Scholarships	6/30/2013	2	1	PS	2	K		01	4	4 children served	Number of children served	05L Child Care Services 570.201e
Performing Stars	6/30/2013	2	1	PS	2	K		01	10	10 children served	Number of children served	05D Youth Services 570.201e
Pickleweed Children's Center	6/30/2013	2	1	PS	2	K		01	10	10 children served	Number of children served	05L Child Care Services 570.201e
Quality Care for Kids Scholarships	6/30/2013	2	1	PS	2	K		01	4	4 children served	Number of children served	05L Child Care Services 570.201e
Rehabilitation Loan Program	6/30/2013	1	2	OOH	1	E		10	15	15 households provided loans	Number of households served	14A Rehab: Single-Unit Residential 570.202
Residential Accessibility Modification Program	6/30/2013	1	1	OOH, RH	1	B,E	✓	04	5	5 housing units made accessible	Number of households served	14A Rehab: Single-Unit Residential 570.202; 14B Rehab: Multi-Unit Residential 570.202
San Rafael ADA Compliance	6/30/2013	2	1	PF	1	M	✓	11	20	20 public facilities improved	Public Facilities improved	03L Sidewalks 570.201c; 03 Public Facilities 570.201c
Senior Access Scholarships	6/30/2013	2	2	PS	2	K	✓	01	24	24 persons served	Number of persons served	05A Senior Services 570.201e
Tomales Town Hall Rehabilitation	6/30/2013	2	1	PF	1	M		11	1	Rehabilitation of community center	Rehabilitation of community center	03E Neighborhood Facilities 570.201c
CDBG Administration	6/30/2013	2	1,2,3	PA	5	A,K,M		9	1	Administration of CDBG program	CDBG Program Administration	21A General Program Administration 570.206
HOME Program Administration	6/30/2013	1	1	PA	5	C		9	1	Administration of HOME Program	HOME Program administration	21A General Program Administration

## CDBG and HOME Projects - 2012-13 Summary of Objectives and Outcomes

Objective Category	Specific Objective
1 Decent housing	A Increase the supply of affordable rental housing
2 Suitable Living Environment	B Improve the quality of affordable rental housing
3 Economic Opportunity	C Improve access to affordable rental housing
Outcome Categories	D Increase the availability of affordable owner housing
1 Availability/Accessibility	E Improve the quality of owner housing
2 Affordability	F Increase range of housing options & related services for persons w/ special needs
3 Sustainability	G Improve access to affordable owner housing
Priority Need Category	H Improve access to affordable owner housing for minorities
RH Rental Housing	I Increase the number of homeless persons moving into permanent housing
OCH Owner Occupied Housing	J End chronic homelessness
PF Public Facilities	K Improve the services for low/mod income persons
I Infrastructure	L Improve quality/increase quantity of neighborhood facilities for low-income persons
ED Economic Development	M Improve quality/increase quantity of public improvements for lower income persons
PS Public Services	N Remediate and redevelop brownfields
PA Planning Administration	O Improve economic opportunities for low-income persons
NSN Non-homeless Special Needs	
O Other	
Accomplishment Type	Explanation
01 People	1 To encourage assistance to community and economic development projects for extremely low, very low, low and moderate income people and neighborhoods
04 Households	2 To provide financial assistance to public service and social service projects serving extremely low, very low, low, and moderate income people
08 Businesses	3 To provide assistance to projects that rectify systemic problems leading to chronic poverty.
09 Organizations	4 To provide financial assistance to facilities serving extremely low, very low, low, and moderate income people and neighborhoods
10 Housing Units	5 Reserve for administration costs for program
11 Public Facilities	
13 Jobs	
Other	



**91.220(d) Geographic Distribution**

For purposes of allocating Community Development Block Grant (CDBG) funds, Marin County has designated six geographic planning areas:

1. Novato Planning Area (includes Novato, Ignacio, Bel Marin Keys, and Black Point)
2. San Rafael Planning Area (includes San Rafael, Los Ranchitos, Lucas Valley, Marinwood, and Santa Venetia)
3. Upper Ross Valley (includes Fairfax, Ross, and San Anselmo)
4. Lower Ross Valley (includes Corte Madera, Larkspur, Greenbrae, Kentfield, and San Quentin)
5. Richardson Bay (includes Belvedere, Mill Valley, Sausalito, Tiburon, Marin City, Strawberry, Tam Valley, and Waldo Point)
6. West Marin, encompassing the inland rural and coastal corridors.

The county has two areas of "minority concentration," defined as Census tracts where the non-white percentage of the population is noticeably greater than the countywide percentage. (Note: The state prison in San Quentin has not been included in these calculations.) Tract 1290, an unincorporated area known as Marin City, has a high concentration of African-Americans. Tract 1122, known as the Canal Area, has a high concentration of Latinos and Asians and Pacific Islanders.

After money is set aside for administrative costs, Marin County's Community Development Block Grant (CDBG) funds are divided, with 40% allocated for housing on a countywide basis and 60% divided among the six planning areas. The planning area funds are used for housing, capital, and public service projects. The formula for distributing CDBG local area funds among Marin County's six planning areas is the same formula that the U.S. Department of Housing and Urban Development (HUD) uses on a national basis to determine Marin County's funding allocation. Three variables are included in the formula:

- Population--the total population of the planning area, expressed as a percentage of the County's total population.
- Overcrowding--the number of households in the planning area which are living in overcrowded conditions (more than one person per room), expressed as a percentage of all the households living in overcrowded conditions in the County.
- Poverty--the number of people in the planning area whose incomes are below the poverty level, expressed as a percentage of all the people in poverty in the County. (This factor is counted twice.)

The four variables (poverty is double-counted) are averaged, and the percentage derived for each planning area represents that area's proportion of Marin's CDBG planning area funds.

The Countywide Housing component of CDBG and all of the funds from the HOME Program are made available for housing projects on a countywide basis, without regard to the location of projects. The availability of CDBG Countywide Housing and HOME funds makes it possible to direct funding to housing opportunities that require a large infusion of funding for a period of one or two years, even if that project is located in an area which does not have sufficient poverty or overcrowding to qualify for a large CDBG planning area allocation. Marin County's local funding formulas balance the need to support local projects with the need to support housing on a countywide basis. This system facilitates funding housing projects outside areas of concentration of poverty, and helps the community address regional housing needs on a regional basis.

For any CDBG Planning Area which includes a city with a population of 50,000 or more (according to population estimates issued by the U.S. Department of Housing and Urban Development), the system described above for allocation of CDBG funds in that Planning Area will, at the option of the largest city in the Planning Area, be modified so that the Planning Area's "proportional share" of CDBG Countywide Housing funds will be added to, and become part of, its planning area allocation. "Proportional share" is defined as the same proportion by which Planning Area funds are distributed among the Planning Areas. The usual policy that at least 30% of each planning area's funds must be spent on housing projects is waived for planning areas which include a city with a population over 50,000. For these planning areas, the City Council of the largest city in the planning area takes on the role of the CDBG Local Area Committee. This policy is in place in the Novato and San Rafael planning areas.

While an overwhelming need for affordable housing is common to all the planning areas, each geographic area is unique and needs vary among the planning areas. The Novato planning area and the San Rafael planning area include the County's two largest urban centers. The Richardson Bay planning area includes Marin City, which has a high concentration of family public housing. Youth development programs are most needed in Marin City and the Canal neighborhood of San Rafael. The West Marin planning area is mostly rural, with a need for geographically dispersed locally-based service providers. The Upper Ross Valley and Lower Ross Valley include medium-sized residential communities.

#### **91.220(e) Homeless and Other Special Needs**

Section 91.220(c) shows the proposed activities to be undertaken serving the homeless and special needs populations. In the list of proposed CDBG and HOME projects, activities serving homeless and special needs populations are so noted.

For additional information about the homeless population in Marin and local efforts to plan to end homelessness in Marin, see Appendix A, *Marin Homelessness Planning Guide, October 2011 (updated April 2012)*.

#### **91.220 Other Actions**

To address obstacles to meeting underserved needs, the County proposes to fund activities directed at underserved populations, including racial and ethnic minorities, people with disabilities, and very low income people. For example, Community Development Block Grant

assistance will be used to support public services for children of low-income minority families (such as the Family Outreach Program of Marin Head Start and various child care programs). Conservation and expansion of the supply of subsidized family rental housing will be a major priority for the use of HUD funds.

To foster and maintain affordable housing, the County will use a large portion of its HUD funding for development, preservation, and rehabilitation of subsidized housing.

To evaluate and reduce lead-based paint hazards, the County will require all recipients of HUD funding to comply with the requirements for lead paint testing and abatement. The Housing Authority will also continue its program of lead paint testing and abatement for public housing.

To reduce the number of poverty-level families, Marin County will continue its extensive employment training program and encourage nonprofit organizations to better coordinate their services to families in distress.

To develop an improved institutional structure and to enhance coordination between public and private housing and social service agencies, the County will encourage more inter-departmental and inter-agency collaboration. Marin County is a participant in the Housing Continuum, which is bringing together representatives of public agencies and private nonprofits to envision better ways to organize the provision of subsidized housing and supportive services. The County will continue the collaboration of the Marin County Department of Health and Human Services, the Marin County Community Development Agency, the Housing Authority, and nonprofit service providers in the provision of housing and supportive services for people with AIDS. The County will continue similar efforts to better organize the provision of services for children in troubled families.

To foster public housing improvements and resident initiatives, the Housing Authority will continue to seek funding for public housing improvements and will provide public housing residents with technical assistance for resident initiatives.

### **Public Housing**

The greatest recent impact on our public housing program has been the extremely tight federal budget, delayed by the deferred federal appropriations process and cut to 88% of eligible subsidy. The Marin County Housing Authority (MHA) is attempting to re-adjust its budget but some services will have to be reduced.

### **Capital Fund:**

The Capital Fund Program (CFP) has generally been the only federal funding for public housing agencies to replace obsolete building systems (heating, electrical, plumbing, ventilation, etc.); make major repairs to elevators, roofs, exteriors, bathrooms, and kitchens; abate hazardous materials; add accessibility modifications; make site improvements; and provide energy upgrades, security, resident services, operating subsidy, and management improvements. During the last fifteen years, construction costs have increased by 203%, thereby cutting the amount of capital improvements that can be accomplished today with each CFP dollar now allocated. During this same period, CFP funding from the federal government has declined dramatically and has not been adequate to cover replacement costs for the aging public housing stock. In

2009, the federal government and HUD recognized this and in the current administration's federal stimulus funding package known as the American Recovery and Reinvestment Act (ARRA), much needed CFP stimulus grants were provided to Public Housing Authorities to address immediate capital repair and replacement needs on a competitive application basis. The Marin Housing Authority's most recent Physical Needs Assessment (PNA) identified over \$16 million in immediate capital improvement needs at its public housing but had only identified \$4 million available in its five-year plan to address these unmet physical needs. Because the Marin Housing Authority aggressively pursued the federal stimulus ARRA CFP grants, the Housing Authority was successful in receiving four additional CFP Capital grants that have allowed the Housing Authority to increase the CFP funding by over \$4 million, allowing additional capital work in its five-year CFP plan. While these additional ARRA grants significantly helped to reduce the Housing Authority's CFP funding gap, it still leaves MHA with the need to identify and pursue any other financing alternatives to preserve MHA's valuable public housing stock.

### **Resident Initiatives**

#### **Phoenix Project**

The Phoenix Project provides prevention and intervention services focused on opening education and employment opportunities to at-risk young men. The project is a partnership between Performing Stars of Marin and the Marin Housing Authority in collaboration with the Sheriff's Department, County Probation, the District Attorney's Office, the Conservation Corps North Bay, Marin City Community Development Corporation, Marin AIDS Project, Bay Area Community Resources, the Marin County Office of Education, and others. It is funded by the Marin Community Foundation, the Milagro Foundation, the Marin County Board of Supervisors, and individual donations.

#### **ROSS Service Coordinator**

Multi-year HUD funding provides service coordination to 200 elderly and disabled residents in the five MHA complexes designated for this population. The primary goal of the ROSS Service Coordinator is to help residents improve their living conditions, enabling them to age-in-place and avoid placement in a full-care facility to the greatest extent possible.

#### **Family Self-Sufficiency (FSS)**

With funding support from the Marin Community Foundation (MCF) and special HUD grants, the Marin County Housing Authority has maintained the Family Self-Sufficiency Program in Marin City family public housing. This program is directed toward improving the economic situation of residents. The Family Self-Sufficiency Program assists 45 families (mostly single mothers) by providing case management and referrals toward individually-crafted educational or employment goals. MCF provides additional multi-year funding to expand FSS with the Work Incentive Program.

#### **Section 3 Resident Training**

The Marin Housing Authority periodically provides short-term training opportunities to public housing residents in maintenance and landscaping trades. Residents work in paid training positions under the supervision of community-based training organizations on maintenance or

landscaping projects at one of MHA's public housing complexes. These projects typically last four to eight weeks and are designed to provide the basic skills which trainees can take to more permanent jobs in the maintenance, construction, or landscaping fields.

**91.220(g) Program-Specific Requirements**

**91.220(g)(1)(i) CDBG**

See 91.220(c) Activities to be Undertaken.

**91.220(g)(1)(ii)(A) CDBG Program Income**

If the CDBG program receives revenue from a completed project, this amount is considered program income, which must be made available to fund new CDBG activities. When CDBG funds are used towards acquisition or major rehabilitation of real estate, a deed of trust or a CDBG lien agreement is usually recorded on the property. The Rehabilitation Loan Program, funded by CDBG, uses a standard note and deed of trust to secure the loans it makes to homeowners. Loans made by the Rehabilitation Loan Program carry a fixed interest rate, which is stated in the loan documents. For other CDBG projects, we generally use a CDBG lien agreement, which is triggered if the property is ever sold or if its use is ever changed, but which never requires payment of principal or interest if the property remains in the same ownership and use. The standard CDBG lien agreement is for a stated percentage of the value of the property, set at the percentage of the project cost contributed by CDBG, so that, if the lien is triggered, the implicit interest rate on the CDBG funds is the rate at which the property has appreciated. In some cases, if a housing development project receives low-income housing tax credits, CDBG assistance may be in the form of an interest-bearing loan, secured by a standard note and deed of trust. In the past program year, two CDBG projects have generated program income.

**Rotary Valley Senior Housing (BRIDGE Housing Corporation and Rotary Valley Associates)**

In 1996, the County of Marin provided \$577,001 in CDBG funds for the development of the Rotary Valley Senior Housing project in Lucas Valley. The CDBG assistance was provided in the form of a loan at 3% interest, but with interest payments restricted to surplus revenue. In April 2011, the project made a \$3,860 interest payment to the CDBG program. Because the loan consisted of both CDBG San Rafael Planning Area funds and CDBG Countywide Housing funds, the loan payments must be split between the San Rafael and Countywide components of the CDBG program. The \$3,860 program income is split so that the San Rafael Planning Area share is \$642 and the Countywide Housing share is \$3,218. This program income is being allocated to new activities as part of this Action Plan. The San Rafael share is being allocated to the San Rafael ADA Compliance Program, and the Countywide Housing share is being allocated to Marinwood Plaza Housing.

**Rehabilitation Loan Program (Marin County Housing Authority)**

The Rehabilitation Loan Program makes loans to eligible homeowners and nonprofit organizations for rehabilitation of single-family houses, including mobile homes, group homes, and houseboats. In the past, revenue from monthly loan payments and repaid loans has been

deposited in the Rehabilitation Loan Program's Revolving Loan Fund and then used to make additional loans. This procedure will continue in the 2012-13 program year. The amount of program income generated by the Rehabilitation Loan Program is volatile and difficult to predict. During the 2010-11 program year (July 1, 2010 to June 30, 2011), the Rehabilitation Loan Program generated \$279,477 in program income. For the 2011-12 program year (July 1, 2011 to June 30, 2012), we expect that this program will generate approximately \$300,000 in program income. For the 2012-13 program year (July 1, 2012 to June 30, 2013), we expect that this program will generate approximately \$450,000 in program income.

Expected Program Income for Program Year 2012-13

For the 2012-13 program year (July 1, 2012 to June 30, 2013), we expect that the Rehabilitation Loan Program will generate approximately \$450,000 in program income.

**2012-13 CDBG PROJECT TO BE FUNDED FROM ANTICIPATED PROGRAM INCOME TO BE RECEIVED IN 2012-13**

1) Rehabilitation Loan Program (Marin County Housing Authority) Housing rehabilitation, Countywide	\$450,000*
Total Projects Funded by Anticipated Program Income	\$450,000*
ESTIMATED CDBG PROGRAM INCOME EXPECTED TO BE RECEIVED DURING 2012-13 PROGRAM YEAR (July 1, 2012 to June 30, 2013) (Source: Rehabilitation Loan Program)	\$450,000*
TOTAL CDBG FUNDS AVAILABLE FROM 2012-13 CDBG GRANT (\$1,166,041) AND ESTIMATED CDBG PROGRAM INCOME (\$450,000) EXPECTED TO BE RECEIVED DURING 2012-13 PROGRAM YEAR	\$1,616,041*

The maximum CDBG funds allowable for general administration = (20%) x (the 2012-13 grant + program income expected to be received during the 2012-13 program year) = (20%) x (\$1,616,041) = \$323,208\*.

The maximum CDBG funds allowable for public services = (15%) x (the 2012-13 grant amount + program income actually received during the 2011-12 program year) = (15%) x (\$1,166,041 + approximately \$350,000\*) = approximately \$227,406\*.

---

\*The amount of program income generated by the Rehabilitation Loan Program is volatile and difficult to predict. Because program income cannot be predicted exactly, the actual amount may vary from this estimate.

### **CDBG Low-Income Benefit**

All of the proposed 2012-13 program year budget allocations, 100% of the \$1,166,041 grant and all program income, will be used for activities benefiting low and moderate income persons.

### **HOME Program Income**

During the 2011-12 program year, we received \$5,000 in HOME program income from the American Dream Downpayment Initiative Program. This amount has been allocated to the Housing for Working Families (Homeward Bound of Marin) project.

We do not anticipate any HOME Program Income for the 2012-13 program year.

### **91.220(g)(1)(ii)(B) & (C)**

These sections are not applicable to Marin.

### **91.220(g)(1)(ii)(D) Income from Float-Funded Activities**

Because of the risk inherent in float-funded activities, Marin County does not engage in any float-funded activities. Therefore, no income is expected to be generated by float-funded activities.

### **91.220(g)(2) HOME Program**

Marin County intends to use its entire HOME allocation for projects described in 24 CFR 92.205(b). The County does not intend to use any HOME funds for projects not described in 24 CFR 92.205(b).

### **Emergency Solutions Grant Program (ESG)**

Marin County intends to identify potential opportunities to procure ESG funding to support shelter programs that currently receive ESG funding through the competitive "balance of state" grant process. Marin County will prioritize project activities previously funded under the former Emergency Shelter Grant Program (now called the Emergency Solutions Grant Program) and those project activities previously funded by the Homeless Prevention and Rapid Rehousing Program, which was funded for one year with Stimulus Bill funds.

### **The Housing Opportunities For Persons With AIDS (HOPWA) Program**

Unlike most HUD intergovernmental programs, HOPWA provides formula grants to the largest city in each eligible metropolitan area, with the requirement that the funds be used to serve the entire metropolitan area. As a result, San Francisco is the recipient for the area consisting of Marin, San Francisco, and San Mateo Counties. San Francisco has agreed to share its allocation with Marin and San Mateo Counties in proportion to the number of people living with AIDS in each county. Marin's share of formula funds flows from HUD to the San Francisco Mayor's Office of Housing, and then to the County of Marin. Marin's funding recommendations are communicated to the San Francisco Mayor's Office of Housing for inclusion in San Francisco's Consolidated Plan, which

serves as the application to HUD for HOPWA funding for the three-county region. San Francisco has designated its Mayor's Office of Housing to administer HOPWA. Locally, HOPWA is administered by the Marin County Community Development Agency. All of the HOPWA funding for Marin County is received via the San Francisco Mayor's Office of Housing, and those amounts are budgeted in San Francisco's Consolidated Plan. Marin's HOPWA allocation is budgeted for an ongoing rental assistance program operated by the Marin Housing Authority and for related administrative expenses. A copy of the proposed Marin HOPWA budget for 2012-13 is included in this Action Plan for informational purposes only.

**91.225      Certifications**

Marin County certifies the following:



## CERTIFICATIONS

In accordance with the applicable statutes and the regulations governing the consolidated plan regulations, the jurisdiction certifies that:

**Affirmatively Further Fair Housing** -- The jurisdiction will affirmatively further fair housing, which means it will conduct an analysis of impediments to fair housing choice within the jurisdiction, take appropriate actions to overcome the effects of any impediments identified through that analysis, and maintain records reflecting that analysis and actions in this regard.

**Anti-displacement and Relocation Plan** -- It will comply with the acquisition and relocation requirements of the Uniform Relocation Assistance and Real Property Acquisition Policies Act of 1970, as amended, and implementing regulations at 49 CFR 24; and it has in effect and is following a residential antidisplacement and relocation assistance plan required under section 104(d) of the Housing and Community Development Act of 1974, as amended, in connection with any activity assisted with funding under the CDBG or HOME programs.

**Drug Free Workplace** -- It will or will continue to provide a drug-free workplace by:

1. Publishing a statement notifying employees that the unlawful manufacture, distribution, dispensing, possession, or use of a controlled substance is prohibited in the grantee's workplace and specifying the actions that will be taken against employees for violation of such prohibition;
2. Establishing an ongoing drug-free awareness program to inform employees about --
  - (a) The dangers of drug abuse in the workplace;
  - (b) The grantee's policy of maintaining a drug-free workplace;
  - (c) Any available drug counseling, rehabilitation, and employee assistance programs; and
  - (d) The penalties that may be imposed upon employees for drug abuse violations occurring in the workplace;
3. Making it a requirement that each employee to be engaged in the performance of the grant be given a copy of the statement required by paragraph 1;
4. Notifying the employee in the statement required by paragraph 1 that, as a condition of employment under the grant, the employee will -
  - (a) Abide by the terms of the statement; and
  - (b) Notify the employer in writing of his or her conviction for a violation of a criminal drug statute occurring in the workplace no later than five calendar days after such conviction;
5. Notifying the agency in writing, within ten calendar days after receiving notice under subparagraph 4(b) from an employee or otherwise receiving actual notice of such conviction. Employers of convicted employees must provide notice, including position title, to every grant officer or other designee on whose grant activity the convicted employee was working, unless the Federal agency has designated a central point for the receipt of such notices. Notice shall include the identification number(s) of each affected grant;

6. Taking one of the following actions, within 30 calendar days of receiving notice under subparagraph 4(b), with respect to any employee who is so convicted:
  - (a) Taking appropriate personnel action against such an employee, up to and including termination, consistent with the requirements of the Rehabilitation Act of 1973, as amended; or
  - (b) Requiring such employee to participate satisfactorily in a drug abuse assistance or rehabilitation program approved for such purposes by a Federal, State, or local health, law enforcement, or other appropriate agency;
7. Making a good faith effort to continue to maintain a drug-free workplace through implementation of paragraphs 1, 2, 3, 4, 5 and 6.

**Anti-Lobbying --** To the best of the jurisdiction's knowledge and belief:

1. No Federal appropriated funds have been paid or will be paid, by or on behalf of it, to any person for influencing or attempting to influence an officer or employee of any agency, a Member of Congress, an officer or employee of Congress, or an employee of a Member of Congress in connection with the awarding of any Federal contract, the making of any Federal grant, the making of any Federal loan, the entering into of any cooperative agreement, and the extension, continuation, renewal, amendment, or modification of any Federal contract, grant, loan, or cooperative agreement;
2. If any funds other than Federal appropriated funds have been paid or will be paid to any person for influencing or attempting to influence an officer or employee of any agency, a Member of Congress, an officer or employee of Congress, or an employee of a Member of Congress in connection with this Federal contract, grant, loan, or cooperative agreement, it will complete and submit Standard Form-LLL, "Disclosure Form to Report Lobbying," in accordance with its instructions; and
3. It will require that the language of paragraph 1 and 2 of this anti-lobbying certification be included in the award documents for all subawards at all tiers (including subcontracts, subgrants, and contracts under grants, loans, and cooperative agreements) and that all subrecipients shall certify and disclose accordingly.

**Authority of Jurisdiction --** The consolidated plan is authorized under State and local law (as applicable) and the jurisdiction possesses the legal authority to carry out the programs for which it is seeking funding, in accordance with applicable HUD regulations.

**Consistency with plan --** The housing activities to be undertaken with CDBG, HOME, ESG, and HOPWA funds are consistent with the strategic plan.

**Section 3 --** It will comply with section 3 of the Housing and Urban Development Act of 1968, and implementing regulations at 24 CFR Part 135.

_____ Signature/Authorized Official Matthew H. Hymel County Administrator _____ Title	_____ Date May 9, 2012
--	------------------------------

## Specific CDBG Certifications

The Entitlement Community certifies that:

**Citizen Participation** -- It is in full compliance and following a detailed citizen participation plan that satisfies the requirements of 24 CFR 91.105.

**Community Development Plan** -- Its consolidated housing and community development plan identifies community development and housing needs and specifies both short-term and long-term community development objectives that provide decent housing, expand economic opportunities primarily for persons of low and moderate income. (See CFR 24 570.2 and CFR 24 part 570)

**Following a Plan** -- It is following a current consolidated plan (or Comprehensive Housing Affordability Strategy) that has been approved by HUD.

**Use of Funds** -- It has complied with the following criteria:

1. **Maximum Feasible Priority.** With respect to activities expected to be assisted with CDBG funds, it certifies that it has developed its Action Plan so as to give maximum feasible priority to activities which benefit low and moderate income families or aid in the prevention or elimination of slums or blight. The Action Plan may also include activities which the grantee certifies are designed to meet other community development needs having a particular urgency because existing conditions pose a serious and immediate threat to the health or welfare of the community, and other financial resources are not available);
2. **Overall Benefit.** The aggregate use of CDBG funds including section 108 guaranteed loans during program year(s) ~~;(a period specified by the grantee consisting of one, two, 2012 or three specific consecutive program years)~~, shall principally benefit persons of low and moderate income in a manner that ensures that at least 70 percent of the amount is expended for activities that benefit such persons during the designated period;
3. **Special Assessments.** It will not attempt to recover any capital costs of public improvements assisted with CDBG funds including Section 108 loan guaranteed funds by assessing any amount against properties owned and occupied by persons of low and moderate income, including any fee charged or assessment made as a condition of obtaining access to such public improvements. However, if CDBG funds are used to pay the proportion of a fee or assessment that relates to the capital costs of public improvements (assisted in part with CDBG funds) financed from other revenue sources, an assessment or charge may be made against the property with respect to the public improvements financed by a source other than CDBG funds.

The jurisdiction will not attempt to recover any capital costs of public improvements assisted with CDBG funds, including Section 108, unless CDBG funds are used to pay the proportion of fee or assessment attributable to the capital costs of public improvements financed from other revenue sources. In this case, an assessment or charge may be made against the property with respect to the public improvements financed by a source other than CDBG funds. Also, in the case of properties owned and occupied by moderate-income (not low-income) families, an assessment or charge may be made against the property for public improvements financed by a source other than CDBG funds if the jurisdiction certifies that it lacks CDBG funds to cover the assessment.

**Excessive Force** -- It has adopted and is enforcing:

1. A policy prohibiting the use of excessive force by law enforcement agencies within its jurisdiction against any individuals engaged in non-violent civil rights demonstrations; and
2. A policy of enforcing applicable State and local laws against physically barring entrance to or exit from a facility or location which is the subject of such non-violent civil rights demonstrations within its jurisdiction;

**Compliance With Anti-discrimination laws** -- The grant will be conducted and administered in conformity with title VI of the Civil Rights Act of 1964 (42 USC 2000d), the Fair Housing Act (42 USC 3601-3619), and implementing regulations.

**Lead-Based Paint** -- Its activities concerning lead-based paint will comply with the requirements of 24 CFR Part 35, subparts A, B, J, K and R;

**Compliance with Laws** -- It will comply with applicable laws.

\_\_\_\_\_  
Signature/Authorized Official  
Matthew H. Hymel  
County Administrator  
\_\_\_\_\_  
Title

May 9, 2012  
\_\_\_\_\_  
Date

**OPTIONAL CERTIFICATION  
CDBG**

~~Submit the following certification only when one or more of the activities in the action plan are designed to meet other community development needs having a particular urgency as specified in 24 CFR 570.208(c):~~

~~The grantee hereby certifies that the Annual Plan includes one or more specifically identified CDBG-assisted activities which are designed to meet other community development needs having a particular urgency because existing conditions pose a serious and immediate threat to the health or welfare of the community and other financial resources are not available to meet such needs.~~

~~\_\_\_\_\_  
Signature/Authorized Official  
\_\_\_\_\_  
Date~~

~~\_\_\_\_\_  
Title~~

**Specific HOME Certifications**

The HOME participating jurisdiction certifies that:

**Tenant Based Rental Assistance** -- If the participating jurisdiction intends to provide tenant-based rental assistance:

The use of HOME funds for tenant-based rental assistance is an essential element of the participating jurisdiction's consolidated plan for expanding the supply, affordability, and availability of decent, safe, sanitary, and affordable housing.

**Eligible Activities and Costs** -- it is using and will use HOME funds for eligible activities and costs, as described in 24 CFR § 92.205 through 92.209 and that it is not using and will not use HOME funds for prohibited activities, as described in § 92.214.

**Appropriate Financial Assistance** -- before committing any funds to a project, it will evaluate the project in accordance with the guidelines that it adopts for this purpose and will not invest any more HOME funds in combination with other Federal assistance than is necessary to provide affordable housing.

May 9, 2012

\_\_\_\_\_  
Signature/Authorized Official  
Matthew H. Hymel  
County Administrator

\_\_\_\_\_  
Date

\_\_\_\_\_  
Title

### HOPWA Certifications

The HOPWA grantee certifies that:

**Activities** -- Activities funded under the program will meet urgent needs that are not being met by available public and private sources.

**Building** -- Any building or structure assisted under that program shall be operated for the purpose specified in the plan:

1. For at least 10 years in the case of assistance involving new construction, substantial rehabilitation, or acquisition of a facility,
2. For at least 3 years in the case of assistance involving non-substantial rehabilitation or repair of a building or structure.

May 9, 2012

Signature/Authorized Official  
Matthew H. Hymel  
County Administrator  
Title

Date

## APPENDIX TO CERTIFICATIONS

### INSTRUCTIONS CONCERNING LOBBYING AND DRUG-FREE WORKPLACE REQUIREMENTS:

#### A. Lobbying Certification

This certification is a material representation of fact upon which reliance was placed when this transaction was made or entered into. Submission of this certification is a prerequisite for making or entering into this transaction imposed by section 1352, title 31, U.S. Code. Any person who fails to file the required certification shall be subject to a civil penalty of not less than \$10,000 and not more than \$100,000 for each such failure.

#### B. Drug-Free Workplace Certification

1. By signing and/or submitting this application or grant agreement, the grantee is providing the certification.
2. The certification is a material representation of fact upon which reliance is placed when the agency awards the grant. If it is later determined that the grantee knowingly rendered a false certification, or otherwise violates the requirements of the Drug-Free Workplace Act, HUD, in addition to any other remedies available to the Federal Government, may take action authorized under the Drug-Free Workplace Act.
3. Workplaces under grants, for grantees other than individuals, need not be identified on the certification. If known, they may be identified in the grant application. If the grantee does not identify the workplaces at the time of application, or upon award, if there is no application, the grantee must keep the identity of the workplace(s) on file in its office and make the information available for Federal inspection. Failure to identify all known workplaces constitutes a violation of the grantee's drug-free workplace requirements.
4. Workplace identifications must include the actual address of buildings (or parts of buildings) or other sites where work under the grant takes place. Categorical descriptions may be used (e.g., all vehicles of a mass transit authority or State highway department while in operation, State employees in each local unemployment office, performers in concert halls or radio stations).
5. If the workplace identified to the agency changes during the performance of the grant, the grantee shall inform the agency of the change(s), if it previously identified the workplaces in question (see paragraph three).
6. The grantee may insert in the space provided below the site(s) for the performance of work done in connection with the specific grant:

Place of Performance (Street address, city, county, state, zip code)  
3501 Civic Center Drive, San Rafael, California 94903  

---

899 Northgate Drive, San Rafael, California 94903  

---

Check \_\_\_ if there are workplaces on file that are not identified here.

The certification with regard to the drug-free workplace is required by 24 CFR part 24, subpart F.

7. Definitions of terms in the Nonprocurement Suspension and Debarment common rule and Drug-Free Workplace common rule apply to this certification. Grantees' attention is called, in particular, to the following definitions from these rules:

"Controlled substance" means a controlled substance in Schedules I through V of the Controlled Substances Act (21 U.S.C. 812) and as further defined by regulation (21 CFR 1308.11 through 1308.15);

"Conviction" means a finding of guilt (including a plea of nolo contendere) or imposition of sentence, or both, by any judicial body charged with the responsibility to determine violations of the Federal or State criminal drug statutes;

"Criminal drug statute" means a Federal or non-Federal criminal statute involving the manufacture, distribution, dispensing, use, or possession of any controlled substance;

"Employee" means the employee of a grantee directly engaged in the performance of work under a grant, including: (i) All "direct charge" employees; (ii) all "indirect charge" employees unless their impact or involvement is insignificant to the performance of the grant; and (iii) temporary personnel and consultants who are directly engaged in the performance of work under the grant and who are on the grantee's payroll. This definition does not include workers not on the payroll of the grantee (e.g., volunteers, even if used to meet a matching requirement; consultants or independent contractors not on the grantee's payroll; or employees of subrecipients or subcontractors in covered workplaces).



## 91.230 Monitoring Standards and Procedures

### Timeliness

In the selection of projects for CDBG and HOME funding, readiness to proceed is a major consideration. County staff make every effort to recommend projects for funding which are ready to proceed in a reasonable period of time. Unfortunately, projects serving low-income people often face neighborhood opposition, which can delay the issuance of local planning approvals. It is difficult to predict the extent of delay that neighborhood opposition may cause. In 1992, the Priority Setting Committee adopted a policy that any project with unspent funds which were allocated to the project over two years ago must be considered for reprogramming to other projects which may be in greater need of the funds. In compliance with this policy, all projects with funds which were allocated two years ago or earlier, as well as newer projects which have been moving slowly, are considered for reprogramming at the annual CDBG and HOME budget hearings.

### Monitoring Standards

Staff of the Marin County Community Development Agency are responsible for monitoring activities funded by the Community Development Block Grant (CDBG) Program, the HOME Program, and the Housing Opportunities for Persons with AIDS (HOPWA) Program. We have two basic standards for monitoring:

- (1) Did the project meet its stated objectives and the requirements of its grant contract?
- (2) Compared with the outcome of other grant-funded projects, did the project have sufficient impact on high-priority needs of low income people, as identified in our Community Development Objectives, Action Plan, Consolidated Plan, the Housing Element and other portions of the General Plan, the Ten-Year Plan to End Homelessness, and other local plans?

Other questions used to determine whether a project meets the basic standards include:

- Is the project, as carried out, clearly eligible under both the letter and the spirit of the program regulations and the statutes that govern the program?
- Is the information being supplied by the project sponsor correct and complete?
- Did the project provide significant benefit to very low income people, as well as to low income people?
- Did the project contribute to economic, social, racial, and ethnic integration?  
Did the project sponsor make a good faith effort at affirmative marketing?  
How effective was the affirmative marketing?
- Did the project sponsor have the capacity to implement the project alone, and if not, did they make appropriate use of consultants and partnerships with other organizations?

- Is the project cost-effective in comparison with other ways to meet the same need?
- Is the activity conducted in a manner that respects the rights of people with disabilities for equal access?
- How responsive is the project sponsor to emerging community needs and the special needs of minorities?
- Has the project sponsor made appropriate outreach to show a commitment to providing culturally sensitive services to all people?
- Has the project sponsor planned the implementation process to consider timing issues and minimize financial risk?
- Has the project sponsor made efforts to utilize volunteers and to raise funds from sources other than HUD grants?

Our main procedure for monitoring is on-site visits, most of which are conducted in the period between December and March in conjunction with our annual budget-setting process. Project monitoring is performed by, or in consultation with, the same staff representative who administers the project contract and approves billings from the project sponsor. This helps integrate our monitoring with our ongoing efforts to provide assistance, advice, and support to the project sponsors.

Our goal is to conduct a monitoring visit of each project within a two-year cycle. We identify high-risk subrecipients and target them for more frequent on-site programmatic and fiscal monitoring. Our criteria for identifying high-risk projects are:

- 1) Project sponsors receiving their first federal grant allocation.
- 2) New project sponsors which lack experience in program administration.
- 3) Project sponsors which have had substantial staff turnover or have recently hired a new executive director.
- 4) Project sponsors which are chronically slow to submit bills.
- 5) Project sponsors who consistently present bills that have errors.
- 6) Project sponsors who attempt to bill CDBG or HOME for clearly ineligible items or show a lack of awareness of CDBG or HOME regulations which apply to their project(s).
- 7) Project sponsors who have been allocated unusually large CDBG or HOME grants.
- 8) Project sponsors who frequently change the scope of their project(s).
- 9) Project sponsors who have a reputation in the community for having troubled projects.

- 10) Projects where service delivery has been disrupted because of internal organizational changes.
- 11) Projects that must comply with Davis-Bacon wage standards.
- 12) Projects that generate an inordinate number of complaints from the public.
- 13) Projects that are the focus of community controversy related to program effectiveness.
- 14) Projects that are not meeting contract goals; for example, if a project is serving a smaller number of clients than projected.
- 15) Projects or project sponsors which have lost significant funding sources.
- 16) Project sponsors who fail to submit demographic reporting data on a timely basis or who submit data that appears questionable.
- 17) Other factors that suggest special scrutiny would be appropriate.

Federal Grants Division staff, working as a group, perform a qualitative ranking of projects based on the above criteria. Projects which trigger one or more of the above criteria are classified as high-risk projects. These high-risk projects are monitored at least once a year. In cases where staff find serious problems with a project sponsor, the sponsor is generally warned that they may not be funded in subsequent years or may have their funding reprogrammed to another project. In addition, as time permits, staff offers sponsors of high-risk projects additional guidance and technical assistance. This may involve meeting with project sponsor staff or board members and suggesting resources to improve project effectiveness.

Projects not considered high-risk are considered low-risk projects and are monitored at least once every two years, with many projects monitored on an annual basis.

The County of Marin is committed to bringing business opportunities to minority- and women-owned business enterprises. By encouraging recipients of grants and/or loans to make a good faith effort to hire minority and women-owned businesses (MBE/WBE), the County hopes to increase business opportunities for disadvantaged businesses. In order to jointly implement the Marin County Minority and Women's Business Outreach program, the Marin County Community Development Agency and Housing Authority have taken the following measures:

- Developing a database of minority and women-owned businesses in construction-related trades (contractors, subcontractors, suppliers) to be jointly used by the County of Marin Community Development Agency and the Housing Authority;
- Updating the database of minority- and women-owned businesses in construction-related trades as new information becomes available;

- Coordinating with community organizations and public agencies that have the capacity to provide names of eligible contractors for the database and technical assistance for the minority and women contractors;
- Providing public information about use of grant funds to qualified contractors and soliciting program participation from these contractors; and
- Encouraging the use of local minority- and women-owned firms whenever possible.

HOME Program grant recipients are informed that they must document a good faith effort to hire minority and women-owned businesses for federally-funded projects. Staff counsels each recipient and prospective recipient on the requirements of the program.

Recipients of HOME funds must document having made a good faith effort to hire minority and women-owned businesses. A good faith effort may include, but not be limited to, the following actions: hiring minority and/or women-owned businesses; keeping a record of phone calls to and interviews with specific contractors to discuss services or products; and solicitation of bid(s) with explanation of reason for rejecting a low bidder.

Nothing in the Minority and Women's Business Outreach Program is intended to prevent any recipient of federal funding from rejecting a contractor whose bid is too high or who does not meet reasonable qualifications.

#### **A Note on the Analysis of Impediments to Fair Housing**

On October 11, 2011, the Marin County Board of Supervisors adopted an Analysis of Impediments to Fair Housing Choice, including an Executive Summary and an Implementation Plan. The County plans to implement the recommendations of the Analysis of Impediments through the priorities established by the Implementation Plan. The Analysis of Impediments to Fair Housing Choice, including the Executive Summary and the Implementation Plan, are incorporated by reference as part of this Consolidated Plan Amendment. For reference, a copy of the Implementation Plan is attached as Appendix B.

SUMMARY LIST OF  
PROPOSED

COMMUNITY DEVELOPMENT  
BLOCK GRANT

AND

HOME INVESTMENT PARTNERSHIPS  
PROGRAM

2012-13 ALLOCATIONS

AND

REPROGRAMMINGS OF PAST  
YEARS' FUNDS

Year 38 Grant	1,166,041
Housing Authority Program Income for the period 6/1/11-12/31/2011	150,087
Other program income	
	<u>1,316,128</u>
	x 15%
	197,419
	<u>(46,352) Fair Housing (funded at 2011 amount)</u>
	<u>151,067 Available for Public Services</u>

Total Grant 1,166,041  
Administration 320,000  
Net Grant 846,041

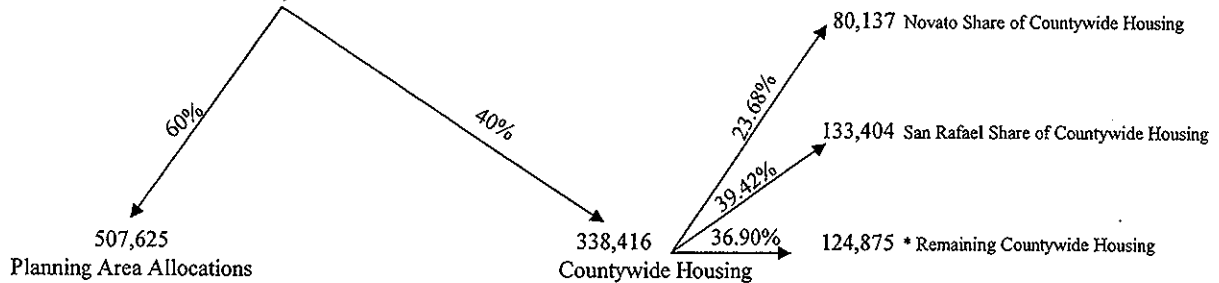

%	Planning Area	Planning Area Allocation	30% Minimum for Housing**	Maximum for Public Services
23.68%	Novato	120,206	0	35,773
39.42%	San Rafael	200,106	0	59,551
8.13%	Upper Ross	41,270	12,381	12,281
7.56%	Lower Ross	38,376	11,513	11,421
15.67%	Richardson Bay	79,545	23,863	23,672
5.54%	West Marin	28,122	8,437	8,369
	Total of			
<u>100.00%</u>	<u>Planning Areas</u>	<u>507,625</u>	<u>56,194</u>	<u>151,067</u>

To be distributed as San Rafael Planning Area Funds:	
Basic San Rafael Planning Area Funds	200,106
San Rafael Share of Countywide Housing	133,404
Total San Rafael Share	333,510
15% to be allocated to Public Services	(50,026)
To be Distributed by San Rafael	<u>283,484 *</u>
City Council for Capital and Housing Projects	

To be distributed as Novato Planning Area Funds:	
Basic Novato Planning Area Funds	120,206
Novato Share of Countywide Housing	80,137
Total Novato Share	<u>200,343</u>

\*\* Novato and San Rafael Planning Areas are not subject to the 30% minimum for housing.

**LOWER ROSS VALLEY PLANNING AREA**

<b>Housing</b>	Rehabilitation Loan Program	Marin Housing Authority	4020 Civic Center Drive, San Rafael 94903	Staff salaries to provide residential rehabilitation loans	\$26,955
					<b>\$26,955</b>

**Capital** There were no capital project proposals this year. **\$0**

<b>Public Service</b>	Family Law Legal Services	Family & Children's Law Center	30 North San Pedro Road, Suite 245, San Rafael 94903	Legal assistance for low income families	\$3,300
	Housing Search Specialist	Marin Housing Authority	4020 Civic Center Drive, San Rafael 94903	Staff salary for housing search specialist	\$1,200
	Marin Brain Injury Network Services	Marin Brain Injury Network	1132 Magnolia Avenue, Larkspur 94939	Staff salaries for services for head injury survivors	\$2,900
	Senior Access Scholarships	Senior Access	70 Skyview Terrace, Bldg. B, San Rafael 94903	Scholarships, elderly day care	\$4,021
					<b>\$11,421</b>
				<b>TOTAL</b>	<b>\$38,376</b>

<b>Total Available for Planning Area</b>	<b>\$38,376</b>
--	-----------------

<b>Maximum Lower Ross Valley funds available for Public Services</b>	<b>\$11,421</b>
--	-----------------

<b>Minimum Lower Ross Valley Planning Area funds required for Housing (County policy requires each planning area to allocate at least 30% of its funds for housing.)</b>	<b>\$11,513</b>
--	-----------------

## NOVATO PLANNING AREA

<b>Housing</b>	Fair Housing	Fair Housing of Marin	615 B Street, San Rafael 94901	Fair housing counseling and education	\$10,976
	Housing for Working Families	Homeward Bound of Marin	5394 Nave Drive, Novato 94949	Offsite improvement costs for affordable housing	\$78,000
	Lifeshouse: Sunrise I-rehabilitation	Lifeshouse Inc	627 Wilson Avenue, Novato 94947	Rehabilitate group home-kitchen	\$20,851
	Rehabilitation Loan Program	Marin Housing Authority	4020 Civic Center Drive, San Rafael 94903	Staff salaries to provide residential rehabilitation loans	\$12,896
	Residential Accessibility Modification Program	Marin Center for Independent Living	Various locations	Housing rehabilitation for handicapped accessibility	\$3,552
					<b>\$126,275</b>

<b>Capital</b>	Hamilton Child Center-Rehabilitation	Community Action Marin Child Development Program	531 Hamilton Parkway, Novato 94949	Child care center-roof replacement	\$9,500
	North Bay Children's Center-Rehabilitation	North Bay Children's Center	932 C Street, Novato 94949	Rehabilitation of building and play yard	\$19,270
					<b>\$28,770</b>

<b>Public Service</b>	Family Outreach Project	Marin Head Start	5520 Nave Drive (94949), 1320 Lynwood Drive (94947), Novato	Family outreach services	\$2,000
	North Bay Children's Center Scholarships	North Bay Children's Center	932 C Street, Novato 94949	Child care scholarships	\$5,300
	Novato Independent Elders Program	Episcopal Senior Communities	1560 Hill Road, Novato 94947	Staff salaries for senior program	\$25,000
	Novato Youth Center-Scholarships	Novato Youth Center	680 Wilson Avenue, Novato 94947	Child care scholarships	\$5,300
	Quality Care for Kids Scholarships	Quality Care for Kids	629 Plum Street (94945), 1320 Lynwood Drive (94947), Novato	Child care scholarships	\$5,698
	Senior Access Scholarships	Senior Access	70 Skyview Terrace, Bldg. B, San Rafael 94903	Scholarships, elderly day care	\$2,000
					<b>\$45,298</b>
				<b>TOTAL</b>	<b>\$200,343</b>

<b>Total funds Available for Planning Area</b>	<b>\$200,343</b>
--	------------------

<b>Maximum Novato Planning Area funds available for Public Services</b>	<b>\$45,298</b>
---	-----------------



**RICHARDSON BAY PLANNING AREA**

<b>Housing</b>	Galilee Harbor-rehabilitation	Galilee Harbor Community Association	300 Napa Street, Sausalito 94965	Public improvements for liveaboard community	\$40,873
	Rehabilitation Loan Program	Marin Housing Authority	4020 Civic Center Drive, San Rafael 94903	Staff salaries to provide residential rehabilitation loans	\$15,000
					<b>\$55,873</b>

**Capital** There were no capital project proposals funded this year.

<b>Public Service</b>	Family Outreach Project	Marin Head Start	610 Drake Avenue, Marin City 94965	Family outreach services	\$7,172
	Marin Learning Center, Therapeutic Services	Community Action Marin Child Development Program	100 Phillips Drive, Marin City 94965	Therapeutic services for children	\$7,000
	Performing Stars	Performing Stars of Marin	271 Drake Avenue, Marin City 94965	Social/self development for low income children	\$7,000
	Senior Access Scholarships	Senior Access	70 Skyview Terrace, Bldg. B, San Rafael 94903	Scholarships, elderly day care	\$2,500
					<b>\$23,672</b>
				<b>TOTAL</b>	<b>\$79,545</b>

<b>Total Available for Planning Area</b>	<b>\$79,545</b>
--	-----------------

<b>Maximum Richardson Bay Planning Area funds available for Public Services</b>	<b>\$23,672</b>
---	-----------------

<b>Minimum Richardson Bay Planning Area funds required for Housing (County policy requires each planning area to allocate at least 30% of its funds for housing.)</b>	<b>\$23,863</b>
---	-----------------

**SAN RAFAEL PLANNING AREA**

<b>Housing</b>	Fair Housing	Fair Housing of Marin	615 B Street, San Rafael 94901	Fair housing counseling and education	\$18,272
	Rehabilitation Loan Program	Marin Housing Authority	4020 Civic Center Drive, San Rafael 94903	Staff salaries to provide residential rehabilitation loans	\$21,469
	Residential Accessibility Modification Program	Marin Center for Independent Living	Various locations	Housing rehabilitation for disabled accessibility	\$5,913
					<b>\$45,654</b>

<b>Capital</b>	San Rafael ADA Compliance	City of San Rafael	Citywide	Accessibility improvements to meet ADA requirements	\$237,830
					<b>\$237,830</b>

<b>Public Service</b>	Family Law Legal Services	Family & Children's Law Center	30 North San Pedro Road, Suite 245, San Rafael 94903	Legal assistance for low income families	\$6,000	
	Family Outreach Project	Marin Head Start	125 Bahia Way, 21 Front Street, 199 Greenfield, 498 Point San Pedro Road, 35 Marin Street (94901), 96 Pilgrim Way, (94903) San Rafael	Family outreach services	\$6,000	
	Housing Search Specialist	Marin Housing Authority	4020 Civic Center Drive, San Rafael 94903	Staff salary for housing search specialist	\$6,000	
	Marin Brain Injury Network Services	Marin Brain Injury Network	1132 Magnolia Avenue, Larkspur 94939	Staff salaries for services for head injury survivors	\$6,026	
	Middle School Program	Canal Alliance	91 Larkspur Street, San Rafael 94901	Staff salaries for after school and summer academic program	\$10,000	
	Pickleweed Children's Center	City of San Rafael	40 Canal Street, San Rafael, CA 94901	Staff salaries for child care	\$10,000	
	Senior Access Scholarships	Senior Access	70 Skyview Terrace, Bldg. B, San Rafael 94903	Scholarships, elderly day care	\$6,000	
						<b>\$50,026</b>
	<b>TOTAL</b>					<b>\$333,510</b>

<b>Total Available for Planning Area</b>	<b>\$333,510</b>
--	------------------

<b>San Rafael Planning Area funds available for Public Services based on 15% of Planning Area allocation</b>	<b>\$50,026</b>
--	-----------------

**UPPER ROSS VALLEY PLANNING AREA**

<b>Housing</b>	Lifeshouse: San Anselmo House-rehabilitation	Lifeshouse Inc	1036 Sir Francis Drake Blvd., San Anselmo 94960	Rehabilitate group home-roof	\$12,500
	Rehabilitation Loan Program	Marin Housing Authority	4020 Civic Center Drive, San Rafael 94903	Staff salaries to provide residential rehabilitation loans	\$16,489
					<b>\$28,989</b>

**Capital** There were no capital project proposals this year. **\$0**

<b>Public Service</b>	After School Transportation Program	Fairfax-San Anselmo Children's Center	199 Porteous Avenue, Fairfax 94930	Staff salaries	\$4,800
	Family Law Legal Services	Family & Children's Law Center	30 North San Pedro Road, Suite 245, San Rafael 94903	Legal assistance for low income families	\$2,000
	Housing Search Specialist	Marin Housing Authority	4020 Civic Center Drive, San Rafael 94903	Staff salary for housing search specialist	\$1,200
	Marin Brain Injury Network Services	Marin Brain Injury Network	1132 Magnolia Avenue, Larkspur 94939	Staff salaries for services for head injury survivors	\$2,100
	Senior Access Scholarships	Senior Access	70 Skyview Terrace, Bldg. B, San Rafael 94903	Scholarships, elderly day care	\$2,181
<b>TOTAL</b>					<b>\$41,270</b>

**Total Available for Planning Area \$41,270**

**Maximum Lower Ross Valley funds available for Public Services \$12,281**

**Minimum Upper Ross Valley Planning Area funds required for Housing (County policy requires each planning area to allocate at least 30% of its funds for housing.) \$12,381**

**WEST MARIN PLANNING AREA**

<b>Housing</b>	Gibson House-storage shed	Bolinas Community Land Trust	20 Wharf Road, Bolinas 94924	Purchase and install two sheds, fencing, etc.	\$9,100
					<b>\$9,100</b>
<b>Capital</b>	Tomales Town Hall-Rehabilitation	Tomales Town Hall	27150 Shoreline Hwy., Tomales 94971	Rehabilitate community center	\$10,653
					<b>\$10,653</b>
<b>Public Service</b>	Home Care Assistance for the Elderly	West Marin Senior Services	11435 State Route 1, Creamery Annex, Point Reyes Station 94956	Home care referrals and assistance for the elderly and disabled	\$3,269
	Human Services Program	San Geronimo Valley Community Center	6350 Sir Francis Drake Blvd., San Geronimo 94963	Staff salaries for center programs	\$5,100
					<b>\$8,369</b>
<b>TOTAL</b>					<b>\$28,122</b>

<b>Total Available for Planning Area</b>	<b>\$28,122</b>
--	-----------------

<b>Maximum West Marin Planning Area funds available for Public Services</b>	<b>\$8,369</b>
---	----------------

<b>Minimum West Marin Planning Area funds required for Housing (County policy requires each planning area to allocate at least 30% of its funds for housing.)</b>	<b>\$8,437</b>
---	----------------

**COMMUNITY DEVELOPMENT BLOCK GRANT COUNTYWIDE FUNDING ALLOCATIONS**

Fair Housing Services	Fair Housing of Marin	615 B Street, Suite #1, San Rafael 94901	Fair housing services	\$17,104
Marinwood Plaza Housing	BRIDGE Housing Corp	121, 155, 175, 197 Marinwood Avenue, San Rafael 94903	Site acquisition and offsite improvements for affordable housing	\$102,236
Residential Accessibility Modification Program	Marin Center for Independent Living	Countywide	Housing rehabilitation for handicapped accessibility	\$5,535

**TOTAL      \$124,875**

### HOME PROGRAM FUNDING ALLOCATIONS

Housing for Working Families	Homeward Bound of Marin	5394 Nave Drive, Novato 94949	Development costs for affordable rental homes	\$446,512
Inverness Valley Inn Housing *	Community Land Trust Association of West Marin	13275 Sir Francis Drake Blvd., Inverness 94937	Acquisition and rehabilitation of affordable housing	\$89,303
HOME Program Administration				\$59,535
				<b>\$595,350</b>

\* This project is designated as a Community Housing Development Organization (CHDO) project, as defined in the HOME regulations. The HOME Program requires that a minimum of 15% of the \$595,350 grant, or \$89,302.50, be spent on CHDO-sponsored projects.

**REPROGRAMMED FUNDS**  
(ALSO INCLUDES ALLOCATIONS OF  
PROGRAM INCOME, WHICH ARE SO NOTED)

**COMMUNITY DEVELOPMENT BLOCK GRANT FUNDS**

<b>REPROGRAMMED FROM</b>	<b>REPROGRAMMED TO</b>	<b>AMOUNT</b>
<b>Novato Planning Area</b>		
Hamilton Neighborhood Services Plan (City of Novato)	Hamilton Child Center-rehabilitation Community Action Marin Child Development Program	\$10,000
Needs assessment and neighborhood services plan	531 Hamilton Parkway, Novato 94949	
Bay Vista, Creekside, and Meadow Park neighborhoods at the former Hamilton Army Air Field, Novato	Child care center-roof replacement HUD-04791-01-07	
HUD-04301-01-07		
<b>Richardson Bay Planning Area</b>		
The Redwoods (Community Church Retirement Center and EAH, Inc.)	Galilee Harbor-Rehabilitation (Galilee Harbor Community Association) 300 Napa Street, Sausalito	\$17,889
Rehabilitation of senior independent living apartments and construction of additional senior independent living apartments	Public improvements for liveaboard community HUD-04441-01-07	
40 Camino Alto, Mill Valley HUD-04439-01-07		
<b>Marin City CDC offices accessibility improvements</b>		
630 Drake Ave., Marin City HUD-04541-01-11	Marin City CDC offices accessibility improvements 441 Drake Ave., Marin City HUD-04541-01-11	\$20,000
<b>San Rafael Planning Area</b>		
Big Brothers Big Sisters Rehabilitation (Big Brothers Big Sisters of Marin and Napa Counties)	San Rafael ADA Compliance (City of San Rafael) Citywide	\$3,095
Rehabilitation of facility serving low income youth	Accessibility improvements to meet ADA requirements	
1618 Second Street, San Rafael HUD-04231-01-06	HUD-04536-01-06	
<b>Rotary Valley Senior Housing Project (Rotary Valley Associates)</b>		
Development of apartments for seniors 1450 Lucas Valley Road, San Rafael	San Rafael ADA Compliance (City of San Rafael) Citywide Accessibility improvements to meet ADA requirements	\$642
<b>PROGRAM INCOME from</b> <i>Interest on the Rotary Valley Senior Housing Project Loan</i>	HUD-04536-01-11	

**REPROGRAMMED FUNDS**  
(ALSO INCLUDES ALLOCATIONS OF  
PROGRAM INCOME, WHICH ARE SO NOTED)

<b>REPROGRAMMED FROM:</b>	<b>REPROGRAMMED TO:</b>	<b>AMOUNT</b>
<b>Countywide</b>		
Gates Cooperative (Gates Cooperative, Marin Housing Authority, and EAH, Inc.)	Rehabilitation Loan Program Marin Housing Authority 4020 Civic Center Drive, San Rafael	\$66,116
Rehabilitation of liveaboard houseboats Waldo Point Harbor, Sausalito Area HUD-04326-01-09	Staff salaries to provide residential rehabilitation loans HUD-04409-01-09	
Rotary Valley Senior Housing Project (Rotary Valley Associates)	Marinwood Plaza Housing BRIDGE Housing Corp	\$3,218
Development of apartments for seniors 1450 Lucas Valley Road, San Rafael	121, 155, 175, 197 Marinwood Avenue, San Rafael 94903 Site acquisition HUD-04796-01-11	
<b>PROGRAM INCOME from</b> <i>Housing Project Loan</i>		
The Redwoods (Community Church Retirement Center and EAH, Inc.)	Marinwood Plaza Housing (BRIDGE Housing Corp.) 121, 155, 175, 197 Marinwood Avenue, San Rafael 94903	\$36,422
Rehabilitation of senior independent living apartments and construction of additional senior independent living apartments 40 Camino Alto, Mill Valley HUD-04439-01-11	Site acquisition HUD-04796-01-11	
Unprogrammed CDBG funds HUD-04631-01-03 (\$157,424)	Marinwood Plaza Housing (BRIDGE Housing Corp.) 121, 155, 175, 197 Marinwood Avenue, San Rafael 94903 Site acquisition HUD-04796-01-03	\$157,424
Unprogrammed CDBG funds HUD-04631-01-03 (\$31,879)	Housing for Working Families (Homeward Bound of Marin) 5394 Nave Drive, Novato 94949 Offsite improvement costs or rehabilitation HUD-04797-01-03	\$31,879
Unprogrammed CDBG funds HUD-04631-01-03 (\$12,993) HUD-04631-01-04 (\$47,704)	Inverness Valley Inn Housing Community Land Trust Association of West Marin (CLAM) 13275 Sir Francis Drake Blvd., Inverness 94937 Acquisition of Inn and rehabilitation for affordable housing HUD-04798-01-03 (\$12,993) HUD-04798-01-04 (\$47,704)	\$60,697



**REPROGRAMMED FUNDS**  
 (ALSO INCLUDES ALLOCATIONS OF  
 PROGRAM INCOME, WHICH ARE SO NOTED)

**HOME PROGRAM**

<i>REPROGRAMMED FROM:</i>	<i>REPROGRAMMED TO:</i>	<i>AMOUNT</i>
American Dream Downpayment Initiative (Marin Housing Authority)	Housing for Working Families (Homeward Bound of Marin) 5394 Nave Drive, Novato 94949	\$5,000
<b>PROGRAM INCOME</b> from the sale of property	Housing development HUD-04797-01-11	

**HOUSING OPPORTUNITIES FOR PERSONS WITH AIDS PROGRAM (HOPWA)  
BUDGET FOR FEDERAL FISCAL YEAR 2012 FUNDS  
(FOR LOCAL PROGRAM YEAR JULY 1, 2012-JUNE 30, 2013)**

<b>A. Rental Assistance Program</b>		
Long-term Rental Assistance Scattered Sites in Marin County	30 very low-income persons living with HIV/AIDS will be assisted with on-going (monthly) housing subsidies for the purpose of providing decent affordable housing.	\$304,640
	<b>Subtotal</b>	<b>\$304,640</b>
<b>B. Project Sponsor Administrative Expenses (Limited to 7% of awarded funds)</b>		
Marin Housing Authority 4020 Civic Center Drive, San Rafael	Sponsor of Long-term Rental Assistance Program.	\$22,929
	<b>Subtotal</b>	<b>\$22,929</b>
<b>C. Grantee Administrative Expenses</b>		
County of Marin 3501 Civic Center Drive, San Rafael	Grantees are limited to 3% of awarded funds for administration costs.	\$10,131
	<b>Subtotal</b>	<b>\$10,131</b>
	<b>Total – Marin County</b>	<b>\$337,700</b>

Legal Notice

Legal Notice

**NOTICE OF REQUEST FOR COMMENTS AND PUBLIC HEARING TO AMEND MARIN COUNTY'S CONSOLIDATED PLAN, ADOPT PROPOSED FISCAL YEAR 2012 AMENDMENTS TO THE 2010-14 MARIN COUNTY CONSOLIDATED PLAN, AND OBTAIN COMMENTS ON HOUSING AND NON-HOUSING COMMUNITY DEVELOPMENT NEEDS OF LOW-INCOME PERSONS**

The County of Marin Consolidated Plan for Fiscal Years 2010-14 (Consolidated Plan) is a planning and budgeting report mandated by the U.S. Department of Housing and Urban Development (HUD) for entitlement communities. The Plan describes the affordable housing and priority non-housing community development needs of extremely low, very low, low, and moderate income persons in the County, and sets forth priorities and strategies for meeting these needs. The County of Marin is required to amend the Consolidated Plan Action Plan annually to reflect the new program year budget for the use of federal Community Development Block Grant (CDBG) and HOME Investment Partnerships Program (HOME) funds. The County is also required to update the Consolidated Plan with new affordable housing and priority non-housing community needs data as it becomes available, and to address public comments received during the public hearings and the comment period.

The proposed budgets for the use of Fiscal Year 2012 CDBG and HOME Program funds will be presented in the Action Plan section of the Consolidated Plan. All activities recommended for funding are consistent with the County's priorities as reported in the Consolidated Plan.

From now through May 7, 2012, the Marin County Community Development Agency will receive comments from interested parties on amendments to the Consolidated Plan, including the budget for the use of federal CDBG and HOME funds for the period July 1, 2012 to June 30, 2013.

On Thursday, March 29, 2012, 7:00 p.m. at the Marin County Board of Supervisors Chambers, Room 330, Administration Building, Marin County Civic Center, 3501 Civic Center Drive, San Rafael, California, the Marin County Countywide Priority Setting Committee will hold a public hearing to request public comment on 1) amendments to the Consolidated Plan; housing and non-housing community development needs of lower income people, and the past performance of the County's Community Development Block Grant (CDBG), HOME, and Housing Opportunities for Persons with AIDS (HOPWA) programs, 2) Budget for 2012-13 for six local CDBG Planning Areas (Novato, San Rafael, Upper Ross Valley, Lower Ross Valley, Richardson Bay, and West Marin), reprogrammings of CDBG funds from previous years, and use of CDBG program income, and 3) Recommended 2012-13 CDBG Countywide Housing allocations, 2012 HOME Program allocations, use of CDBG funds from previous years, and use of CDBG program income.

Paper copies of the draft amendments to the Consolidated Plan are available upon request. The draft amendments will be available at the Marin County Community Development Agency, Federal Grants Office, 899 Northgate Drive, Room 408, San Rafael, between the hours of 9:30 a.m. and 5:00 p.m., 499-6279; as are all records and reports regarding the use of past CDBG, HOME, and HOPWA funds. A copy of the draft amended Consolidated Plan will also be sent to those that request it by calling 499-6279.

On Tuesday, May 8, 2012, the Marin County Board of Supervisors will hold a final public hearing to receive comments from interested parties on the revised Consolidated Plan and its proposed amendments, including the use of Fiscal Year 2012 funds, and to hear comments from all interested parties on past program performance and housing and non-housing community development needs of extremely low, very low, low, and moderate income persons in the County. The public hearing will be held during the regular meeting of the Marin County Board of Supervisors at 9:00 a.m. or thereafter (call 499-6279 on or after May 4 for precise time), in Room 330, Administration Building, Marin County Civic Center, 3501 Civic Center Drive, San Rafael, California.

The public hearing location is accessible by wheelchair and public transportation. People with impaired speech or hearing using TDD devices may reach us through the California Relay Service in English and Spanish at 711. Sign language interpretation, translation into languages other than English, and documents in alternate formats for people with visual impairments are available upon request. If you need sign or other interpretation, please call our office at 499-6279, at least three days in advance of the hearings.

Please call Reid J. Thaler (499-6695) if you are not able to attend the public hearings but would like to comment on the proposed amendments to the Consolidated Plan, or housing and non-housing community development needs. Comments may also be sent to: Reid J. Thaler, Marin County Community Development Agency, 3501 Civic Center Drive, San Rafael, California 94903.

An Assessment of Marin County's Consolidated Plan performance, prepared by the U.S. Department of Housing and Urban Development, is available at the Community Development Agency, 899 Northgate Drive, Room 408, San Rafael.

**NOTICE OF NONDISCRIMINATION POLICY**

The County of Marin does not discriminate on the basis of handicap in violation of 24 CFR Part 8 in admission or access to, or treatment or employment in, its federally assisted programs and activities, including those funded by the Community Development Block Grant Program, the HOME Program, and the Housing Opportunities for Persons With AIDS Program. Anyone with questions about this policy or the activities of the programs listed above may contact Roy Bateman at the Community Development Agency, Federal Grants Division, 899 Northgate Drive, Room 408, San Rafael, CA 94903, phone 499-6698. The person who has been designated to process grievances under this policy is the Disability Access Manager, Marin County Civic Center, Room 304, San Rafael, California 94903, phone 473-4381. People using Telecommunications Relay Service devices may reach all County of Marin offices, including the Section 504 Compliance Office and the Marin County Community Development Agency by calling 711.

# MARIN HOMELESSNESS PLANNING GUIDE

---

OCTOBER 2011

UPDATED APRIL 2012

HEALTH & HUMAN SERVICES POLICY AND PLANNING

FOR QUESTIONS REGARDING THIS DOCUMENT:

CONTACT: LISA SEPAHI

[lsepahi@marincounty.org](mailto:lsepahi@marincounty.org)

415-473-3501



If you are a person with a disability and require this document in an alternate format (example: Braille, Large Print, Audiotape, CD-ROM), you may request an alternate format by calling the number above.

# Homeless Counts and Resources

Homelessness is a complex problem that impacts persons from every background, age, gender and socio-economic class. There are many challenges to preventing and addressing homelessness. Despite this, what we know is that the solution is surprisingly simple-affordable housing.

Homelessness occurs most often due to an individual or family's inability to afford housing, the lack of affordable housing options also prolongs the time persons spend homeless.

In Marin:

- Approximately 1,220 children and adults are homeless. 42% are sheltered in emergency shelters or transitional housing, 29% are without shelter (living on the street, cars, camps) and 29% were sheltered in other settings (motels, jails, temporarily with friends/family).
- Families with children comprise 35% of the population. The remaining 65% are individuals.

## Homeless Subpopulations<sup>1</sup>

2011 PIT	Sheltered	Unsheltered
<i>Chronically Homeless</i>	86	143
<i>Mentally Ill</i>	77	104
<i>Substance Abuse</i>	265	101
<i>Veteran</i>	31	36
<i>HIV/AIDS</i>	8	6
<i>Domestic Violence</i>	63	15
Unaccompanied Youths	0	1

## Precariously Housed

	Families	Individuals	Total
Households	1,042	477	1,519
Persons			4,179

## HOMELESS RESOURCES

Prevention assistance ranges from short-term rental assistance to legal assistance to prevent eviction. The following agencies provide homelessness prevention.

### Prevention Services

Agency	Prevention Services
Adopt A Family	Novato Human Needs
Canal Alliance	Ritter Center
Community Action Marin	St. Vincent de Paul Society
Legal Aid of Marin	West Marin Resource Center

## Point-in-Time Counts

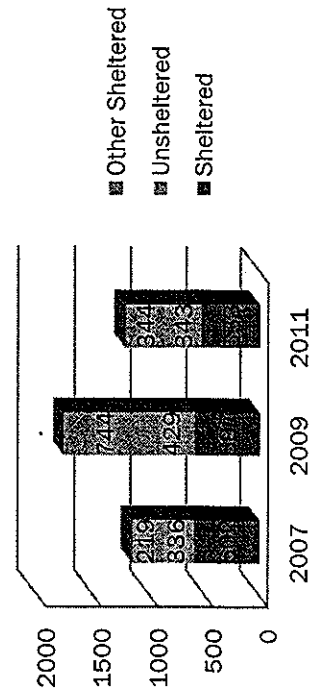

### 2011 Emergency Shelter<sup>ii</sup>

Agency	Emergency Shelter	Families
	Individuals	
Homeward Bound	120	49
Center for Domestic Peace (MAWS only)	(Domestic Violence only)	20
REST (seasonal)	66	-

Emergency Shelter is defined as temporary accommodation which does not exceed 6 months. Emergency shelter is provided on a night to night basis for single individuals.

### 2011 Transitional and Permanent Supported Housing for Homeless<sup>iii</sup>

Agency	Transitional Housing Beds		Permanent Supported Housing Beds	
	Ind.	Fam.	Ind.	Fam.
Homeward Bound	53	88	71	13
Center for Domestic Peace	0	76	0	0
Center Point Inc.	62	15	0	2
Marin AIDS Project	6	5	0	0
Ritter Center	12	0	14	0
Gilead House	0	9	0	0
Marin Housing Authority	0	0	97	9
MHA-VASH (Vet housing)	0	0	28	7
Bucklew	0	0	201	0
St. Vincent de Paul Society	0	0	8	0
Fireside-Eden Housing	0	0	8	35
Total	133	193	411	66
Combined Total	326		477	

Transitional Housing is dedicated housing for persons coming from the street or from an emergency shelter. Transitional housing may only be provided for up to 2 years and is often accompanied by supportive services such as case management.

Permanent Supported Housing is housing dedicated to persons who are homeless and have a disabling condition such as a mental health or physical disability. Housing is provided with on-going support to maintain housing stability.

### Affordable Housing

There are a number of affordable housing options in Marin which include Section 8 Housing, Senior Housing and units for low-income households. However the number of units available and the range of affordability is limited. The figure below shows the number of workers needing housing according to affordability and the number of units available.

Affordable Rental Needs and Current Supply<sup>iv</sup>

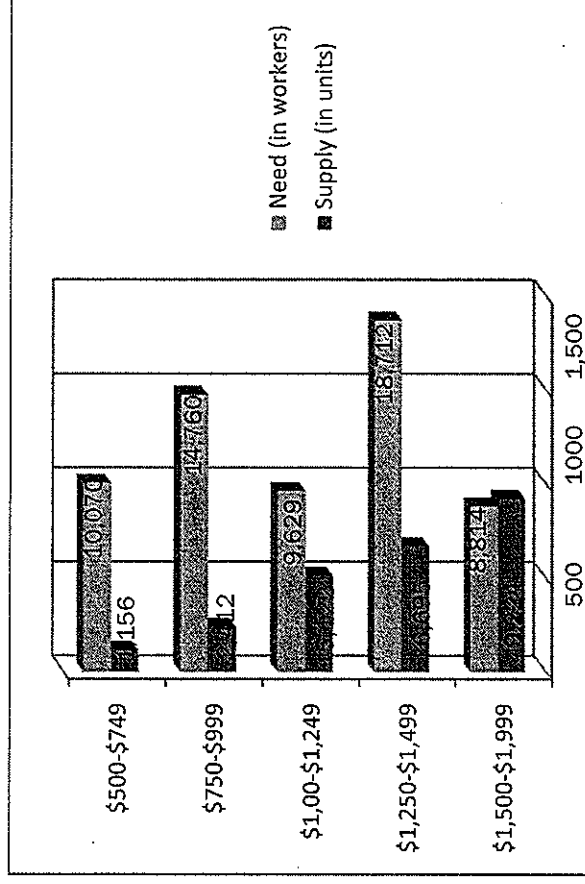

While Marin County has a supply of supportive and affordable housing, it is not adequate to meet the current need. The rate of turnover of rental units is very low, meaning that at any given time there are only a limited number of units available to rent. The current vacancy rate for rentals is less than 1%. A 5% rental vacancy rate is considered crucial to permit ordinary rental mobility.

# Causes of Homelessness

## Unemployment and wages

Unemployment has risen significantly in the past four years from 4,800 in 2007 to 10,000 unemployed at the end of 2011. This represents a 108% increase in the number of persons claiming unemployment. Unemployment, reduction in hours and wages all have an impact on the growing number of precariously housed and the number of persons experiencing first time homelessness.

## Marin Unemployment

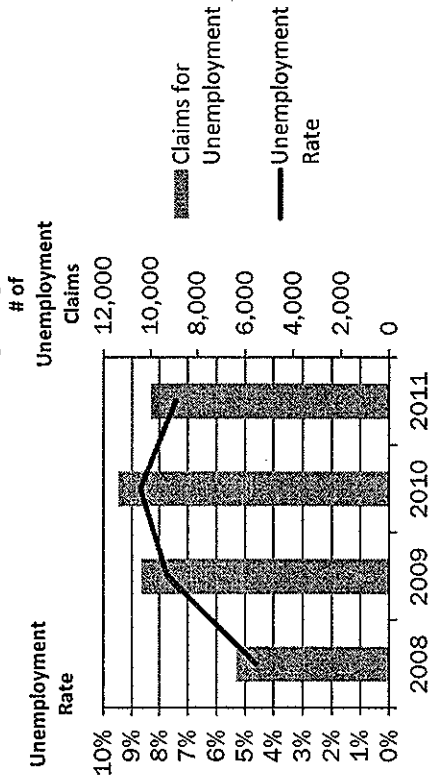

For those that are employed wages are often not enough to cover basic expenses. The following chart is an example of jobs at very-low, low-income and moderate income levels in Marin County along with a comparison of affordable rent and the income gap between income and expenses.

Bay Area Wages and Affordable Rents<sup>v</sup>

Bay Area Wages and Affordable Rents	Hourly Wage	Annual Income	Affordable Rent	Median Rent Gap
Extremely Low Income- 30%-50% of median income				
Home Health Aides	\$11.54	\$24,000	\$600	-\$910
Retail Salespersons	\$14.06	\$29,250	\$731	-\$779
Security Guards	\$14.67	\$30,510	\$763	-\$747
Very low income- Less than 50% of median income				
Preschool Teachers	\$17.52	\$36,440	\$911	-\$599
Medical Assistants	\$18.49	\$38,450	\$961	-\$549
Pharmacy Technician	\$19.23	\$40,430	\$1,011	-\$499
Low Income - 50%-80% of Median				
Dental Assistant	\$20.98	\$43,640	\$1,091	-\$419
Emergency Medical Technicians and Paramedics	\$24.49	\$50,950	\$1,252	-\$258
Chefs and Head Cooks	\$26.01	\$54,090	\$1,352	-\$158
Moderate Income - 80%-100% of Median				
Tax Preparer	\$29.13	\$60,600	\$1,515	+\$5
Legal Secretaries	\$31.46	\$65,430	\$1,636	+\$126
Dietician	\$32.54	\$67,670	\$1,692	+\$182

54% of Marin in-commuters earn less than \$40,000 a year, a typical apartment opportunity in Marin is well out of reach for the majority of in-commuters.<sup>vi</sup>

## Poverty and Self-sufficiency

According to American Community Survey Census 2010, 9.1% of Marin's population is estimated to live below 100% of the Federal Poverty Level (FPL) See Figure 1 below. <sup>vii</sup> Poverty and homelessness are closely linked. When households lack income to provide for basic needs, they are forced to choose between housing costs, childcare, healthcare and food. Many households in Marin are not able to make enough income to maintain stable housing. When comparing cost of housing (see figure 2) to the income of persons below 100-200% federal poverty level it is easy to see why many families and individuals fall into homelessness.

Figure 1: Poverty and rent affordable at poverty level in Marin County <sup>viii</sup>

Persons in Family	Earnings for persons at 100% FPL	Affordable Monthly Rent at this Wage	Earnings for persons at 200% FPL	Affordable Monthly Rent at this Wage
1	\$908	\$272	\$1,815	\$544
2	\$1,226	\$368	\$2,452	\$736
3	\$1,544	\$463	\$3,088	\$926
4	\$1,863	\$559	\$3,725	\$1,117
5	\$2,181	\$654	\$4,362	\$1,309

- Number of persons living below 100% of the Federal Poverty Level- 22,191 <sup>ix</sup>
- Number of persons living below 200% of the Federal Poverty Level- 47,082 <sup>x</sup>

The standard measure for housing affordability is set at 30% <sup>xi</sup> of monthly income to allow households to afford housing and have additional income for other living costs. Many households due to the high cost of rent pay well above 50% of household income to afford housing this increases a household's vulnerability to homelessness.

Figure 2: Housing Wage <sup>xii</sup> (Income needed to afford housing in Marin)

	Fair Market Rent <sup>xiii</sup>	Hourly Housing Wage Needed (full-time 40 Hours a week)
0 Bedroom	\$1,238	\$23.80
1 Bedroom	\$1,522	\$29.27
2 Bedroom	\$1,905	\$36.63
3 bedroom	\$2,543	\$48.90

The Housing Wage represents the hourly wage needed to afford a rental at fair market rates. Fair Market Rents are set by the Department of Housing & Urban Development Annually and reflect a proportion of typical rents for standard units in an area. Rental housing is far out of reach for many whose income falls well below the average cost of a rental in Marin.

There are 61,000 Marin workers who commute from outside the county every day. Many of these commuters are unable to afford rent of \$1,000 or more. For these households there is only one apartment for every seven workers seeking an apartment at less than \$1,000 a month. <sup>xiv</sup>



# Community Performance Goals and System-wide Outcomes

The HEARTH Act goals require communities to set performance goals based on the Acis key performance areas. Communities are expected to develop strategies which address these goals. The Homeless Policy Steering Committee has approved a draft of these goals which includes:

1. Reduce the length of time people spend in homelessness (National goal is 30 days or less)
2. Reduce the number of homeless
3. Reduce the number of homeless families
4. Reduction in the number of newly homeless
5. Increase the number of persons exiting transitional housing to permanent housing
6. Increase employment and income growth for homeless families and individuals

Goal 1: Reduce the length of time people spend in homelessness		Goal 4: Reduce number of newly homeless	
2011 Length of time unsheltered	Families	Individuals	2011 Newly Homeless
1 week or less	2%	1%	1 week or less 3
1-3 Months	11%	13%	1-3 Months 20
3-12 Months	19%	22%	3-12 Months 34
1-4 Years	9%	32%	
5-9 Years	2%	11%	
10+ Years	0%	12%	
Unknown	57%	9%	
		Goal 5: Increase % exiting to permanent housing from transitional Housing	
		Percent Exiting to Permanent Housing	78%
		Families	78%
		Individuals	78%
Goal 2 and 3: Reduce the number of Homeless		Goal 6: Increase employment and income growth for homeless	
Total	2011 Sheltered	2011 Unsheltered	% of persons employed after ext from transitional or permanent housing.
Individuals	303	496	2010 2011
Families (total persons)	230	191	41% Not available
Chronically Homeless	86	143	
Older Adults 62+	24	36	
Transition Age Youth (18-24)	26	48	
		Total	

# Homeless Demographics

2011 COUNT-Age of Single Adults

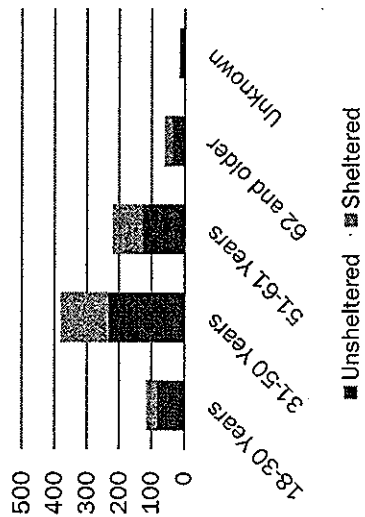

2011 COUNT-Age of Persons in Households with Children

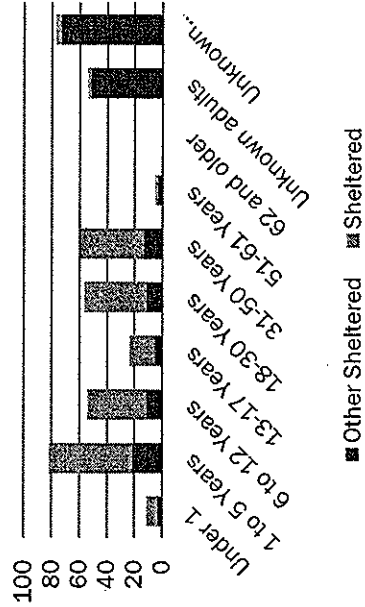

- The majority of single homeless adults are between the ages of 31-50.
- Families with children tend to be younger and have children under the age of five.
- Unsheltered adults compared with sheltered adults have reported significantly more health and substance abuse problems. Although drug and alcohol use are comparable.
- Households with children report fewer health problems than single adults.

2011 Count-Disabling Conditions Self-Reported by Single Adults

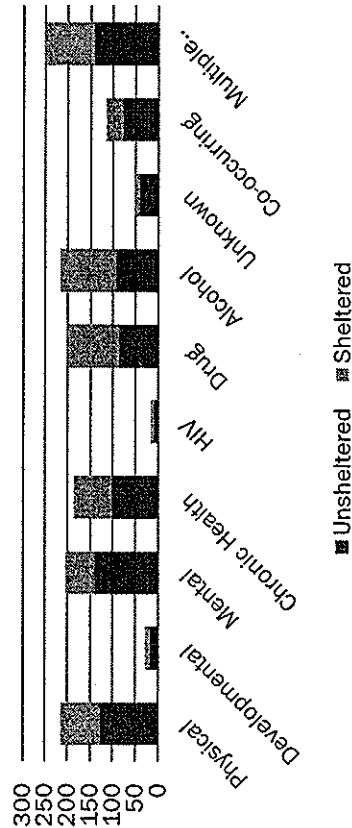

2011 COUNT-Disabling Conditions Reported by Adults in Households with Children

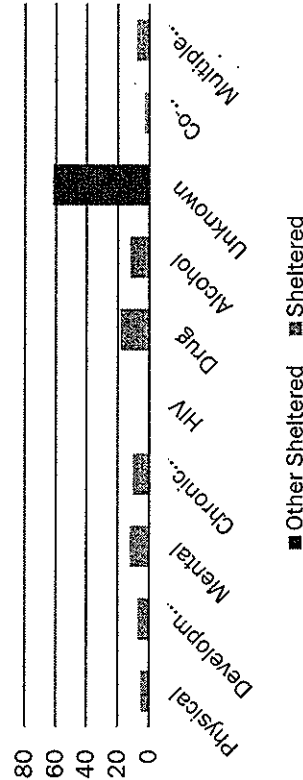

# Homeless Demographics

**Last Placed Stayed Before Entering Family Shelter-2011**

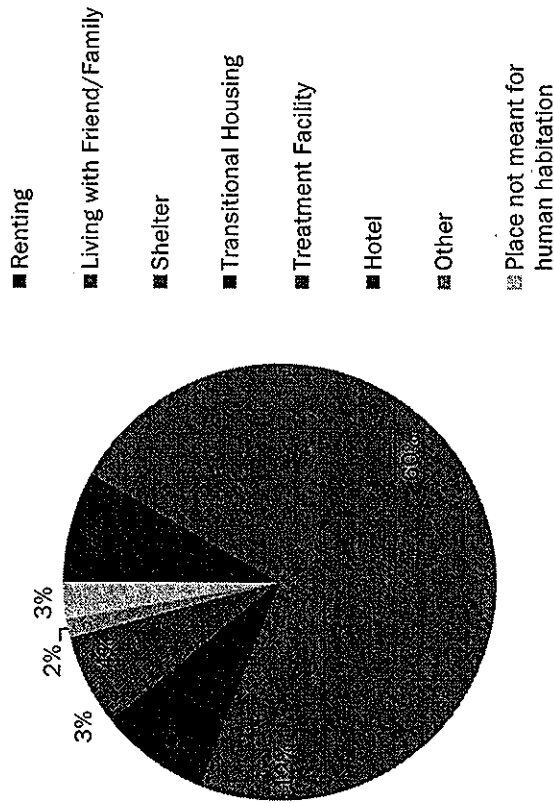

**Last Place Stayed Before Entering Mill Street-NBC-2011 (Single Adults)**

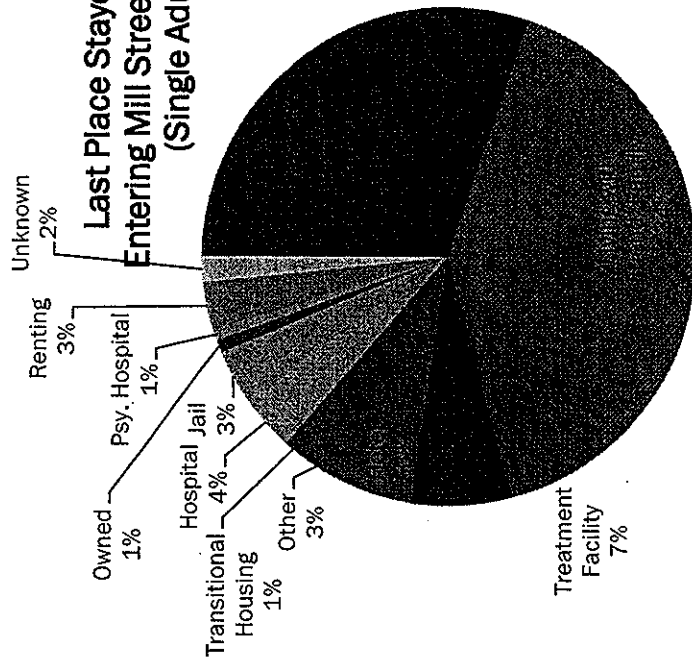

# Community-Wide Cost of Homelessness

The cost of homelessness can be evaluated based on a number of factors. This chart represents only those services dedicated to serving persons experiencing homelessness or those at risk of homelessness.

Annual Funds Dedicated To Prevention and Homeless Services  
(Fiscal Year 09-10)

Total Funds	\$2,190,755
Prevention-Financial Assistance	\$2,221,099
Emergency Shelter	\$1,438,868
Transitional Housing	\$9,111,789
Permanent Supported Housing	\$2,500,000
Domestic Violence Shelter & Housing	\$4,593,367
Supportive Services*	\$6,384,028
HHS Programs-GA, CalWORKS, Public Health, Administration, AOD	
<b>Total</b>	<b>\$28,006,263</b>

\*Supportive Services Includes: St. Vincent's Dining Room and direct assistance, Next Key and Bucklew Employment Services.

## Annual Homeless Service Dollars

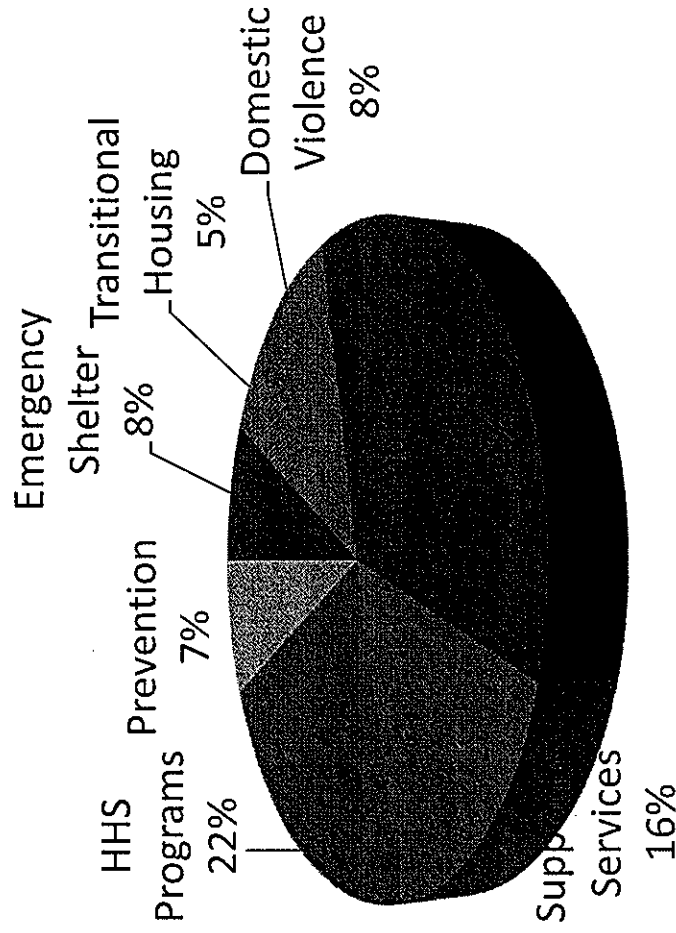

# Federal Changes Effecting Communities

## Implementation of the HEARTH Act of 2009 (Federal Statute)

### Outcome Focus:

1. Reduce number of homeless persons
2. Reduce time spent in homelessness
3. Increase the number of people placed in permanent housing (WA State addition)

### Strategic Focus:

- Homeless Prevention
- Rapid Rehousing
- Permanent Supportive Housing for the Chronically Homeless

The Homeless Emergency Assistance and Rapid Transition to Housing Act (HEARTH) has implications community-wide. It provides a framework for the development and improvement of homeless systems and requires communities to demonstrate a commitment to reducing the amount of time persons spend in homeless and reducing the number of persons experiencing homeless through the use of "proven" strategies.

### HEARTH Paradigm Shift

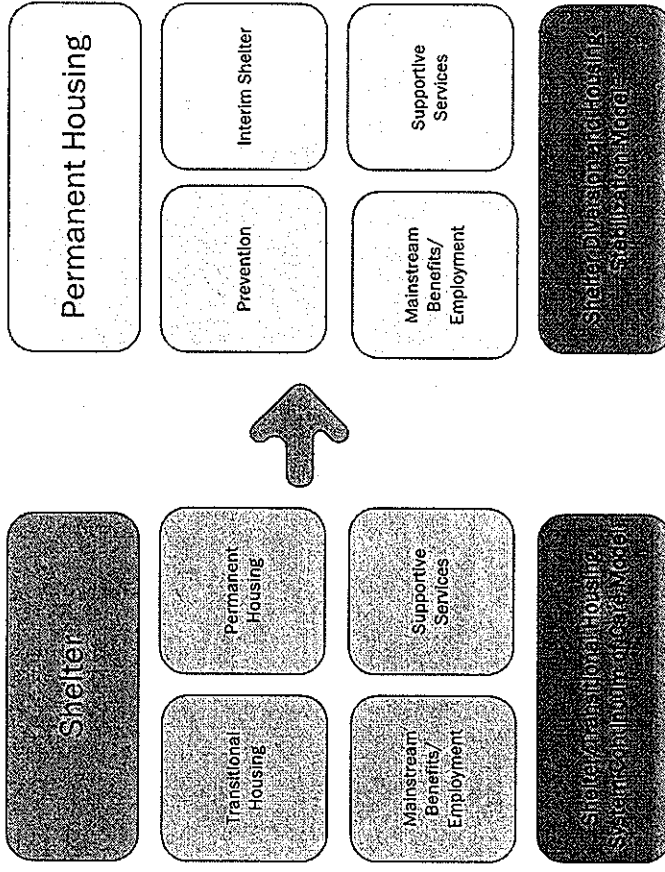

# Open Doors-Federal Strategic Plan to Prevent and End Homelessness: 2010

---

The U.S. Interagency Council on Homelessness (USICH) developed and published the first federal strategic plan to end homelessness in 2010. The focus of this plan is interagency collaboration that aligns mainstream housing, health, education and human services to prevent Americans from experiencing homelessness.

The plan contains four key goals:

- Finish the job of ending chronic homelessness in five years
- Prevent and end homelessness among veterans in five years
- Prevent and end homelessness for families, youth, and children in ten years
- Set a path to ending all types of homelessness.

The federal strategic plan seeks to accomplish this through five core approaches or themes:

1. Increase leadership, collaboration and civic engagement at all levels of government and across all sectors.
2. Increase access to stable and affordable housing for people experiencing or most at-risk of homelessness, and provide access to permanent supportive housing for chronically homeless persons.
3. Increase economic security by increasing meaningful and sustainable employment as well as access to mainstream programs and services to reduce vulnerability to homelessness.
4. Improve health and stability by integrating primary and behavioral health care services for persons experiencing or most at risk of homelessness; improve discharge planning from community institutions of care, and advance health and housing stability for high users of public services and systems..
5. Retool the homeless crisis response system to incorporate best practices for crisis response programs, enhanced coordination with mainstream resources, and improved collaboration among all federal, state and local agencies addressing homelessness.

# U.S. Veterans' Administration Five Year Plan to End Veteran Homelessness

---

Due to the large numbers of military personnel returning to the U.S. following the wars in Iraq and Afghanistan and the difficulties many have had in transitioning to successful civilian life, the federal Veterans' Administration developed a Five Year Plan to End Homelessness among Veterans that was issued in November of 2009.

The key findings of these efforts included:

- Homelessness is often a consequence of multiple psychosocial factors, including unstable family supports, job loss, inadequate job skills, health problems, substance use disorder, or other mental health concerns.
- Homeless services cannot be provided in isolation.
- Homeless services must be comprehensive.

The federal veterans' homeless strategy is built upon six core pillars, which mirror approaches to ending homelessness among many other populations:

1. Outreach and/or Education – led by the VA and community partners; use of the VA National Homeless Call Center
2. Treatment – access to treatment under a “no wrong door” approach which includes: assessment, comprehensive treatment and rehabilitative treatment (medical, dental, mental health and substance abuse care)
3. Prevention – programs for justice-system involved veterans; supportive services for low-income veteran families
4. Housing and/or Supportive Services – provision of transitional and permanent housing with supportive services in collaboration with federal and community partners; provision of community-based residential treatment
5. Income/Employment/Benefits Assistance – includes employment assistance, access to entitlement benefits, short-term financial assistance, vocational rehabilitation and supportive employment.
6. Community Partnerships –

# Best Practices

---

Best practices are those practices which have been tried, tested and shown to work to prevent, reduce or end homelessness. The following includes a list of some of the successful "best practices" utilized in communities working to end homelessness.

**Housing First-** "A growing body of research is documenting the effectiveness of the Housing First approach, particularly when used in working with homeless persons who have serious behavioral health and other disabilities. This research indicates that the approach is effective both at placing and retaining persons in permanent housing and at reducing the costs associated with these individuals within the healthcare and judicial systems."<sup>xv</sup> Housing First programs are intended to target the hardest-to-serve homeless who have a serious mental illness, often with a co-occurring substance-related disorder. These programs are designed to increase housing stability for people who traditionally have been very difficult to house. The presumption is that once housing stability is achieved, clients are better prepared to address their mental illness and substance-related disorders. In addition, program housing combined with support services can stabilize a client's financial status and promote self-sufficiency.<sup>xvi</sup>

**Shelter Diversion-** "Diversion is a strategy that prevents homelessness for people seeking shelter by helping them identify immediate alternate housing arrangements and, if necessary, connecting them with services and financial assistance to help them return to permanent housing. Diversion programs can reduce the number of families becoming homeless, the demand for shelter beds, and the size of program wait lists. Diversion programs can also help communities achieve better outcomes and be more competitive when applying for federal funding."<sup>xvii</sup> The services families are provided include: provision of financial, utility, and/or rental assistance; short-term case management; conflict mediation; connection to mainstream services and/or benefits; and housing search. The main difference between diversion and other permanent housing-focused interventions centers on the point at which intervention occurs. Prevention targets people at imminent risk of homelessness, diversion targets people as they are applying for entry into shelter, and rapid re-housing targets people who are already homeless.

**Prevention-**Prevention efforts include a wide range of activities such as housing relocation and stabilization assistance, financial assistance, mediation to prevent eviction and emergency food, clothing, transportation. Best practices show that a wide-range of prevention activities should be available to meet the diverse needs of households at risk of homelessness. Some programs which have shown promise in this area include: medium-term rental subsidies (12-18 months), budget and credit counseling, one-time financial assistance, housing location and relocation assistance (assisting households to locate and move into more affordable housing), and legal assistance to prevent eviction.



**Rapid Re-housing-** Rapid Re-Housing is a strategy that has been successfully used by many communities to reduce homelessness. Many households become homeless as a result of a financial crisis that prevents them from paying the rent, or a domestic conflict that results in one member being ejected or leaving with no resources or plan for housing. Most households who become homeless today have already lived in independent permanent housing, and they can generally return and remain stably housed with limited assistance. By helping homeless households return to permanent housing as soon as possible, communities have been able to reduce the length of time people remain in homeless shelters. This opens beds for others who need them, and reduces the public and personal costs of homelessness. Rapid Re-Housing provides financial assistance for households to move quickly into permanent housing.<sup>xviii</sup>

**Critical Time Intervention-**The Critical Time Intervention model (CTI) was developed in New York City as a program to increase housing stability for persons with severe mental illnesses and long-term histories of homelessness. Its principle components are rapid placement in transitional housing, fidelity to a Critical Time Intervention CTI model for families (i.e., provision of an intensive, 9-month case management intervention, with mental health and substance use treatments), a focused team approach to service delivery, with the aim of reducing homelessness, and brokering and monitoring the appropriate support arrangements to ensure continuity of care.<sup>xix</sup>

**Centralized Intake-** By centralizing intake and program admissions decisions, a coordinated entry process makes it more likely that families will be served by the right intervention more quickly. In a coordinated system, each system entry point ("front door") uses the same assessment tool and makes decisions on which programs families are referred to based on a comprehensive understanding of each program's specific requirements, target population, and available beds and services.<sup>xx</sup>

**Trauma Informed Care-**Trauma-informed care is an approach to engaging people with histories of trauma that recognizes the presence of trauma symptoms and acknowledges the role that trauma has played in their lives. Programs that are informed by an understanding of trauma respond best to consumer needs and avoid engaging in re-traumatizing practices. People experiencing homelessness have high rates of trauma stemming from experience of violence, loss and disruptions to important relationships at an early age. Additionally people who are homeless experience the loss of place, stability, and community. This trauma has a major impact on how people understand themselves and the world around them. A trauma informed approach aims to create an environment which promotes physical and emotional safety as well as consumer choice. Being trauma informed means adopting a holistic view of care and recognizing the connections between housing, employment, substance abuse mental and physical health and trauma histories.<sup>xxi</sup>

**Master Leasing-** Master leasing is a strategy for creating supportive housing in which existing housing units are leased from for-profit housing owners and then subleased to individuals and families. The sponsor agency of a master leasing program is typically a County or City agency (such as a Department of Human Services), although in many programs the government sponsor agency contracts with a nonprofit

organization to identify and lease, sublease and operate the units. Master leasing programs are usually initiated for the purpose of providing permanent affordable, supportive housing for specific target populations identified by the sponsor agency oftentimes homeless individuals who have complex needs, particularly chronically homeless people with co-occurring disabilities.<sup>xviii</sup>

## 10 Year Plan 2006-2011

---

Major accomplishments in the first five years of the Ten-Year Plan include:

- Rotating Emergency Shelter Program established.
- Introduction of 211, Network of Care to improve and coordinate access to services.
- Established Homeless Management Information System to improve data collection and service coordination.
- Transition to Wellness program for homeless discharging from hospitals.
- Jail discharge program "Custody to Community".
- Project Homeless Connect hosted in all jurisdictions.
- Established Homelessness Awareness Campaign "Homeforall"
- Established Homeless Policy Steering Committee overseeing community wide planning related to homelessness.
- Fireside Affordable Housing Built housing homeless families and seniors.
- Homeward Bound's Next Key built providing transitional housing for
- Homeless Prevention and Rapid Rehousing Program prevented homelessness for 340 persons and rehoused 237 homeless
- Housing First Program established providing housing for 14 chronically homeless individuals.
- Developed better understanding of homeless needs through county-wide Point in Time Counts.
- Hired Homelessness Analyst to oversee homeless strategy and local planning.
- Increased public benefits outreach in the community.

- 
- <sup>i</sup> Marin Health & Human Services (2011) Point-in-time Count of Persons Experiencing Homelessness
- <sup>ii</sup> Marin County (2011) Housing Inventory <http://www.hudhre.info/index.cfm?do=actionHomelessnessrptsSearch>
- <sup>iii</sup> Ibid
- <sup>iv</sup> Non-Profit Housing Association (2011) Driving home economic recovery: how workforce housing boost jobs and revenues in Marin.
- <sup>v</sup> U.S. Bureau of Labor Statistics (2010) Metropolitan and Non-metropolitan are occupational employment and wages-San Francisco\_San Mateo-Redwood City. Retrieved 10-11-11 <http://www.bls.gov/oes/current/oesrca.htm>
- <sup>vi</sup> Non-Profit Housing Association (2011) Driving home economic recovery: how workforce housing boost jobs and revenues in Marin.
- <sup>vii</sup> U.S. Census Bureau. (2005-2009) American Community Survey. S1701 Poverty Status in Last 12 months. Retrieved July 22, 2011, from <http://www.census.gov/>.
- <sup>viii</sup> 2011 Federal Poverty level <http://aspe.hhs.gov/poverty/11poverty.shtml>, Insight: Center for Community Economic Development. (2008). *How much is enough in Marin County?* [www.insightceod.org](http://www.insightceod.org). Oakland, CA
- <sup>ix</sup> U.S. Census Bureau. (2005-2009) American Community Survey. S1701 Poverty Status in Last 12 months. Retrieved October 4, 2011, from <http://www.census.gov/>.
- <sup>x</sup> Ibid
- <sup>xi</sup> Affordable Housing Standard, Retrieved 4/4/2012 <http://www.hud.gov/offices/cpd/affordablehousing/>
- <sup>xii</sup> National Low Income Housing Coalition (2011) Out of reach 2011, renters await the recovery.
- <sup>xiii</sup> Department of Housing and Urban Development (2011) FY2011-Final Fair Market Rents for Existing Housing. [www.huduser.org/portal/datasets/fmr2011/fy2011f\\_scheduleB\\_rev2.p..](http://www.huduser.org/portal/datasets/fmr2011/fy2011f_scheduleB_rev2.p..)
- <sup>xiv</sup> Non-profit Housing Association of Northern California. Driving Home Economic Recovery: How workforce housing boosts jobs and revenues in Marin. (Marin Community Foundation) 2011.
- <sup>xv</sup> Ibid
- <sup>xvi</sup> Abt. Associates (2007) The Applicability of Housing First Models to Persons with Severe Mental Illness, U.S. Department of Housing and Urban Development, Office of Policy Development and Research.

- 
- <sup>xvii</sup> National Alliance to End Homelessness (2011) Closing the front door: Creating a successful diversion program for homeless families. Retrieved October 19, 2011 from <http://www.endhomelessness.org/content/article/detail/4155>
- <sup>xviii</sup> National Alliance to End Homelessness (2009) Rapid Rehousing: Creating programs that work. Retrieved on October 19, 2011 from <http://www.endhomelessness.org/content/article/detail/2450>
- <sup>xix</sup> National Alliance on Mental Illness. Critical Time Intervention with Homeless Families, Retrieved on October 19, 2011 from [www.nami.org](http://www.nami.org)
- <sup>xx</sup> National Alliance to End Homelessness (2011) One way in: The advantages of introducing a system-wide coordinated entry for families. Retrieved on October 19, 2011 from <http://www.endhomelessness.org/content/article/detail/3974>
- <sup>xxi</sup> Homelessness Resource Center. Trauma informed care 101. Retrieved October 19, 2011 from <http://homeless.samhsa.gov/resource/trauma-informed-care-101-46857.aspx>
- <sup>xxii</sup> Bristol, K. (2010) Marin county housing study: Analysis of best practices to meet the housing needs of homeless and precariously housed people in Marin county.



COUNTY OF MARIN

ANALYSIS OF IMPEDIMENTS TO FAIR HOUSING CHOICE

IMPLEMENTATION PLAN

*(As approved by the Marin County Board of Supervisors on October 11, 2011)*

Most of the recommendations in this Implementation Plan are based on the recommendations in the Executive Summary of the draft Analysis of Impediments to Fair Housing Choice, which can be found at [www.marincdbg.com](http://www.marincdbg.com). Some of the recommendations listed in the Implementation Plan emerged from the testimony and discussion that occurred in the course of the public hearing process. (Public hearings were held on the Analysis of Impediments on March 29, May 11, May 23, May 24, May 31, July 25, July 27, August 24, September 12, and October 11, 2011.)

This document is organized in two sections:

- (1) Actions for the County government to undertake.
- (2) Actions for other agencies to undertake.

While the focus of many policy items is on the County government, and the commitment for performance falls primarily on the County, many of the recommendations also apply to some or all of the other local jurisdictions (cities and towns). To avoid unnecessarily complicating the Implementation Plan, we have not posted details on the status of each community on each recommendation. Information in the Time Frame column applies to the County, rather than other local jurisdictions. The general approach is that the County government will take the lead on implementation. The County's implementation of recommendations within the designated timeframes will be dependent upon the availability of funding and staff resources.

The Community Development Block Grant (CDBG) Countywide Priority Setting Committee currently consists of one member of the Marin County Board of Supervisors and one member of each City/Town Council, except for the Town of Ross, which participates in the program but not the Committee. For the local hearings in the six Planning Areas, the Local Area Committee

consists of all the Council appointees to the Priority Setting Committee from the cities and towns in the Planning Area plus a County Supervisor whose supervisorial district most closely coincides with the Planning Area. In the case of Novato and San Rafael, the City Councils have the option to substitute for the Local Area Committee. In most years, the Priority Setting Committee has met once or twice to make CDBG and HOME Program budget recommendations to the Board of Supervisors. The Board of Supervisors and all the City/Town Councils in Marin have signed Cooperation Agreements that will make it possible to expand the Priority Setting Committee and its local area subcommittees to add community members who represent classes protected under federal civil rights laws.

The expanded Priority Setting Committee will have an oversight and communications role in relation to the Implementation Plan, and will add extra meetings to its annual schedule to perform these functions. In its communications role, the Priority Setting Committee will be a public forum for mutual discussion of progress being made by the County, Cities, and Towns on the items included in the Implementation Plan, the obstacles they have encountered, and ways they have found to overcome obstacles. In its oversight role, the Priority Setting Committee will receive reports from staff about progress on the items listed in the Implementation Plan.

In addition, as a condition of the County's receipt of urban county CDBG and HOME funds, HUD requires the County to be aware of actions the cities and towns are taking, and to be prepared to take sanctions (including excluding a city from the CDBG and HOME programs) if a city's actions interfere with the County's annual certification to HUD that Marin localities are collectively acting to affirmatively further fair housing.

#### A Note on the Difference between Affordable Housing and Fair Housing

The draft Analysis of Impediments identifies barriers to fair housing choice in Marin County. We should be clear that "fair housing" means the ability to buy or rent housing without being subject to discrimination on the basis of race, ethnicity, age, disability, gender, the presence of children, or other categories protected under the law. As the Analysis of Impediments points out, lack of affordable housing can be a barrier to fair housing, so there is much overlap between affordable housing and fair housing issues. Still, it is useful to keep in mind that affordable housing and fair housing are separate concepts, and to distinguish between state and federal requirements.

## ANALYSIS OF IMPEDIMENTS TO FAIR HOUSING CHOICE

### IMPLEMENTATION PLAN

<b>SECTION 1: ACTIONS FOR IMPLEMENTATION BY COUNTY GOVERNMENT</b>					
<b>Recommendations</b>	<b>Responsibility</b>	<b>Potential Funding</b>	<b>Priority</b>	<b>Time Frame</b>	<b>Status</b>
1. County will adopt a compliant Housing Element by 2013 for the 2007-14 cycle, and within 18 months after adoption of the Regional Transportation Plan (RTP) for the 2014-21 cycle.	County	May require additional funding	High	Medium	
1. <i>Notes: This recommendation emerged from testimony and discussion in the course of the public hearing process. Completion of this action is dependent upon State certification of the County's Housing Element Update for the 2014-2022 Housing Element Cycle.</i>					
2. Explore opportunities to establish "Welcoming Community" programs or expand existing programs that may be well suited to providing welcoming services to make Marin residents from protected classes feel more welcome in the community. Provide information and tools for these new residents to connect and become part of the community. Connect long-time Marin residents with protected class residents.	County; Nonprofits	Will require additional funding	Medium	Short	



**SECTION 1: ACTIONS FOR IMPLEMENTATION BY COUNTY GOVERNMENT**

Recommendations	Responsibility	Potential Funding	Priority	Time Frame	Status
<p>2. <i>Notes: This recommendation emerged from testimony and discussion in the course of the public hearing process.</i></p>					
<p>3. Expand diversity program for County staff, and explore ways to include elected officials and planning commissioners in diversity programs.</p>	<p>County</p>	<p>Will require additional funding</p>	<p>Medium</p>	<p>Medium</p>	
<p>3. <i>Notes: This recommendation emerged from testimony and discussion in the course of the public hearing process. Marin County Human Resources Department, Marin County Health and Human Services Cultural Competence Committee, and Marin County Human Rights Commission are potential resources.</i></p>					
<p>4. Make fair housing and equal opportunity criteria a more visible and comprehensive part of the Community Development Block Grant (CDBG) and HOME Program project selection process by screening all CDBG and HOME applications for compliance with fair housing and equal opportunity criteria and including an analysis of equal opportunity impact in staff reports recommending projects for funding.</p>	<p>County</p>	<p>Existing budget</p>	<p>Medium</p>	<p>Short</p>	
<p>4. <i>Notes: This recommendation emerged from testimony and discussion in the course of the public hearing process. The CDBG application form will include a specific question about the applicant's plans for affirmative marketing or affirmatively furthering fair housing. In addition, when distributing application forms and when providing information to prospective applicants, County staff will take steps to alert potential applicants to the importance of their response to this question and their compliance with affirmative marketing requirements.</i></p>					

**SECTION 1: ACTIONS FOR IMPLEMENTATION BY COUNTY GOVERNMENT**

Recommendations	Responsibility	Potential Funding	Priority	Time Frame	Status
5. Expand CDBG Priority Setting Committee to include non-elected community representatives of protected classes.	County; Cities; Community Groups; Nonprofits	Existing budget	High	Short	
<p><i>5. Notes: This recommendation emerged from testimony and discussion in the course of the public hearing process. The County-City cooperation agreements have been amended to allow for expanded representation. CDBG staff will send letters to all Cities and Towns to inform them that, although each City/Town traditionally appoints a Councilmember as its representative on the CDBG Priority Setting Committee, they have an option to select a person who is not a Councilmember as their representative on the CDBG Priority Setting Committee, and this could be used to increase the number of members who represent protected classes.</i></p>					
6. Hold additional meetings of CDBG Priority Setting Committee to discuss AI implementation by County and Cities/Towns, report on fair housing actions each jurisdiction has accomplished, and discuss obstacles they face in the community to affirmatively furthering fair housing.	Priority Setting Committee	Existing budget	High	Short	
<p><i>6. Notes: This recommendation emerged from testimony and discussion in the course of the public hearing process. Each Town/City should consider assigning a staff person to support this activity. The County will work with local nonprofits with connections to minority communities to publicize these meetings.</i></p>					

**SECTION 1: ACTIONS FOR IMPLEMENTATION BY COUNTY GOVERNMENT**

<b>Recommendations</b>	<b>Responsibility</b>	<b>Potential Funding</b>	<b>Priority</b>	<b>Time Frame</b>	<b>Status</b>
7. Assign CDBG Priority Setting Committee an oversight role for the Implementation Plan. The Priority Setting Committee will track actions localities take to affirmatively further fair housing. The Priority Setting Committee will lead a process of peer evaluation of each community's efforts to affirmatively further fair housing.	Priority Setting Committee	Existing budget	Medium	Short	
7. <i>Notes: This recommendation emerged from testimony and discussion in the course of the public hearing process.</i>					
8. Sponsor workshops on civic participation and recruitment of minorities for board and commission positions.	County; Grassroots Leadership Network	Will require additional funding	Medium	Short	
8. <i>Notes: This recommendation emerged from testimony and discussion in the course of the public hearing process. The County will work with local nonprofits with connections to minority communities to coordinate these efforts.</i>					
9. Adopt design guidelines for multi-family developments as a means to permitting affordable housing projects either ministerially or through a streamlined process of discretionary design review.	County	Will require additional funding	High	Medium	

**SECTION 1: ACTIONS FOR IMPLEMENTATION BY COUNTY GOVERNMENT**

Recommendations	Responsibility	Potential Funding	Priority	Time Frame	Status
<p>9. <i>Notes: Design guidelines would entail a community planning process at a cost estimated to be between \$75,000 and \$100,000. Increasing densities may require CEQA analysis to evaluate environmental impacts.</i></p>					
<p>10. Expand overlay zones, with increased density standards and minimum density requirements for affordable housing.</p>	<p>County</p>	<p>Will require additional funding</p>	<p>High</p>	<p>Medium</p>	
<p>10. <i>Notes:</i></p>					
<p>11. Rezone a sufficient number of suitable sites to accommodate the lower-income Regional Housing Need Allocation (RHNA) for higher density affordable multi-family housing by December 31, 2013.</p>	<p>County</p>	<p>Will require additional funding</p>	<p>High</p>	<p>Short</p>	
<p>11. <i>Notes: Increasing densities above the potential maximum levels of housing development allowed by the current Countywide Plan will require CEQA analysis to evaluate environmental impacts. In the interest of efficiency and economy, this work should be conducted as part of the environmental review of the current (2007-2014) Housing Element update. County will attempt to complete this item ahead of schedule according to the Housing Element update work program previously adopted by the Board of Supervisors.</i></p>					
<p>12. In areas where the mixed-use policies of the Countywide Plan promote mixed-use with ground-floor retail, continue policy to exempt affordable housing from this requirement.</p>	<p>County</p>	<p>Existing budget</p>	<p>High</p>	<p>Medium</p>	

**SECTION 1: ACTIONS FOR IMPLEMENTATION BY COUNTY GOVERNMENT**

Recommendations	Responsibility	Potential Funding	Priority	Time Frame	Status
<i>12. Notes:</i>					
<p>13. Implement and consider strengthening inclusionary zoning requirements. Where they exist, review criteria for allowing inclusionary units to be developed off-site. Amend zoning ordinance to consider allowing inclusionary units to be built off-site only when an analysis of the fair housing implications has been prepared, in addition to applying other relevant criteria. For example, the analysis could address whether the receiving site is located in a less diverse neighborhood than the project.</p>	County	May require additional funding	Medium	Short	
<i>13. Notes: The County is currently in the process of implementing this recommendation through pending changes to its Development Code which seek to clarify inclusionary zoning requirements and the criteria for requesting waivers.</i>					
<p>14. Pursue additional local funding options to support affordable housing.</p>	County, Marin Workforce Housing Trust	Will require additional funding	Medium	Ongoing	
<i>14. Notes: The County currently funds affordable housing through a variety of means including in-lieu fees, impact fees, commercial linkage fees, general funds, and the Marin Workforce Housing Trust.</i>					

**SECTION 1: ACTIONS FOR IMPLEMENTATION BY COUNTY GOVERNMENT**

Recommendations	Responsibility	Potential Funding	Priority	Time Frame	Status
<p>15. Diversify development of affordable housing with multiple strategies and types of housing. For example, do not depend solely or primarily on second units as an affordable housing production strategy. Require commercial development to include affordable housing.</p>	<p>County</p>	<p>May require additional funding</p>	<p>High</p>	<p>Ongoing</p>	
<p><i>15. Notes: The County's 2009 Draft Housing Element includes a number of programs related to this recommendation which are scheduled for implementation during the current housing element cycle (2007-2014), including "Establish Minimum Densities on Housing Element Sites," "Require Multi-family Residential Development in Multi-family Zones," and "Zone and Provide Appropriate Standards for SRO Units." The County's current Development Code already requires commercial developments to include affordable housing.</i></p>					
<p>16. Encourage and facilitate the development of more subsidized and affordable housing for families with children outside areas of minority concentration. Consider acquisition and shared housing. Screen and prioritize applications for CDBG and HOME funds for housing projects that will serve families and are located outside areas of minority concentration.</p>	<p>County; Marin Housing Authority</p>	<p>May require additional funding</p>	<p>Medium</p>	<p>Ongoing</p>	

**SECTION 1: ACTIONS FOR IMPLEMENTATION BY COUNTY GOVERNMENT**

Recommendations	Responsibility	Potential Funding	Priority	Time Frame	Status
<p>16. <i>Notes: The County completed a program from the 2009 Draft Housing Element (“Conduct a Comprehensive Affordable Housing Sites Inventory”) to identify and designate sites for multifamily housing development to meet the housing needs of Marin’s workforce, seniors, and special needs populations. These sites will be evaluated for the potential to increase densities which will facilitate multifamily affordable housing developments. Locating sites outside areas of minority concentration is a weighted factor being considered when identifying sites. The majority of sites identified thus far meet this standard.</i></p>					
<p>17. In funding and selecting sites for affordable housing designed for people with disabilities, consider the need for such housing in diverse geographic locations, as well as the need for services such as retail and public transit in close proximity.</p>	<p>County</p>	<p>May require additional funding</p>	<p>Low</p>	<p>Ongoing</p>	
<p>17. <i>Notes: The County will seek to address this recommendation when implementing programs, including, “Encourage Housing for Special Needs Households,” from the 2009 Draft Housing Element. However, the County does not build affordable housing, and most affordable housing funding prioritizes development close to services and transportation.</i></p>					
<p>18. Conduct regular surveys of privately developed affordable housing projects which are subject to local government restrictions on household income, to determine racial and ethnic demographics of residents.</p>	<p>County</p>	<p>May require additional funding</p>	<p>High</p>	<p>Short term for instituting tracking system; ongoing for data collection</p>	
<p>18. <i>Notes: This is required by the Voluntary Compliance Agreement between HUD and the County.</i></p>					

**SECTION 1: ACTIONS FOR IMPLEMENTATION BY COUNTY GOVERNMENT**

Recommendations	Responsibility	Potential Funding	Priority	Time Frame	Status
19. Reword guiding principles in zoning ordinances and development regulations that may be a pretext for discrimination; add language noting intention to expand housing opportunities for all.	County	May require additional funding	Medium	Short Term	
<p><i>19. Notes: The County does not foresee the need for additional funds to make these changes and is in the process of reviewing and amending the Development Code to implement this recommendation. County is in the process of making these changes to the Affordable Housing chapter of its Development Code. Other chapters of the Development Code could be reviewed and clarified where needed.</i></p>					
20. Provide assistance for property owners to make old residential properties accessible. Consider giving priority in the Rehabilitation Loan Program to hardship cases where accessibility improvements are needed.	County; Marin Center for Independent Living (MCIL); Housing Authority	Will require substantial additional funding	Low	Long Term	
<p><i>20. Notes:</i></p>					
21. Support legislation to prevent predatory lending practices, to set standards for assisting homeowners seeking loan modifications, and to provide recourse to victims of improper foreclosures.	County; Advocates; Fair Housing of Marin	Existing budget	Low	Long Term	



**SECTION 1: ACTIONS FOR IMPLEMENTATION BY COUNTY GOVERNMENT**

Recommendations	Responsibility	Potential Funding	Priority	Time Frame	Status
21. <i>Notes: Consult with County's legislative analysts and request to add to County's legislative platform through the Office of the County Administrator.</i>					
22. County will track development of affordable housing towards Regional Housing Needs Allocation (RHNA).	County	Existing budget	Medium	Ongoing	
22. <i>Notes: Local governments are required to track development of housing toward RHNA needs and report annually to the Department of Housing and Community Development (HCD) on or before April 1st of each year.</i>					
23. Rank recommendations from Analysis of Impediments and add to Consolidated Plan.	County	Existing budget	High	Short Term	
23. <i>Notes: The "Priority" column in this document shows the ranking of each recommendation.</i>					
24. Publicize Analysis of Impediments public hearing process to raise awareness of barriers to fair housing choice.	County; Fair Housing of Marin	Existing budget	High	Short Term	
24. <i>Notes: In process.</i>					
25. Incorporate community recommendations in Analysis of Impediments.	County	Existing budget	High	Short Term and Ongoing	
25. <i>Notes: Recommendations from the community hearing process are included in this Implementation Plan.</i>					

**SECTION 1: ACTIONS FOR IMPLEMENTATION BY COUNTY GOVERNMENT**

Recommendations	Responsibility	Potential Funding	Priority	Time Frame	Status
26. Ensure that one County department monitors and tracks progress on Analysis of Impediments recommendations.	County	May require additional resources	High	Ongoing	
<p><i>26. Notes: County needs to quantify the cost implications. Monitoring of fair housing actions is eligible as a CDBG administrative expense. However, the cost of monitoring may exceed the 20% limit on use of CDBG funds for administration.</i></p>					
27. Provide more information in Spanish and Vietnamese, including tenants' housing rights information and services provided to protected classes.	County; Nonprofits	May require additional funding	High	Short	
<p><i>27. Notes: The County's responsibility for implementing this recommendation is based on the Voluntary Compliance Agreement.</i></p>					
28. Update Analysis of Impediments every two to five years, or as necessary to reflect data from the decennial Census. Revisit Implementation Plan, which is part of the AI, at the same time.	County	Will require additional resources	High	Ongoing	
<p><i>28. Notes: Use a Request for Qualifications (RFQ) process or similar procedure to select a contractor to update the Analysis of Impediments.</i></p>					

**SECTION 1: ACTIONS FOR IMPLEMENTATION BY COUNTY GOVERNMENT**

Recommendations	Responsibility	Potential Funding	Priority	Time Frame	Status
29. County will establish local procedures to monitor all County government programs that receive state or federal funding for compliance with Title VI and other federal and state requirements, including fair contracting, hiring, and job training opportunities.	County	Will require additional resources	Medium	Medium	
<p><i>29. Notes: This will require coordination among at least six County Departments. Staff will work with the County Administrator's Office on determining the feasibility, timeline and budget for carrying out these actions.</i></p>					

**SECTION 2: ACTIONS FOR IMPLEMENTATION BY OTHER AGENCIES:**

<b>Recommendations</b>	<b>Responsibility</b>	<b>Potential Funding</b>	<b>Priority</b>	<b>Time Frame</b>	<b>Status</b>
<p>30. Use the Marin County Task Force on Housing Discrimination as a forum to address fair housing issues and encourage broader involvement from the community in addressing these fair housing issues. Seek to expand the membership of the Task Force to engage impacted communities, local government, and area businesses.</p>	<p>Fair Housing of Marin</p>	<p>Existing Budget</p>	<p>Medium</p>	<p>Short</p>	
<p>30. Notes:</p>					

**SECTION 2: ACTIONS FOR IMPLEMENTATION BY OTHER AGENCIES:**

Recommendations	Responsibility	Potential Funding	Priority	Time Frame	Status
<p>31. Pursue expanded opportunities to use additional transit funds to address the transportation needs of low-income communities and low-income households. Consider increasing transportation options in higher-income, less impacted communities to increase housing options for transit-dependent people. Encourage transit hubs with affordable housing outside areas of minority concentration. Increase transit so more sites will qualify for low income housing tax credits. Develop transit hubs where high-density housing is permitted, outside areas of minority concentration.</p>	<p>Transportation Authority of Marin; Marin Transit District</p>	<p>Assumes increased resources for public transit</p>	<p>Pending consultation with transit agencies</p>	<p>Pending consultation with transit agencies</p>	
<p>31. Notes:</p>					
<p>32. Assess the effectiveness of the Housing Authority's communications with non-English-speaking clients.</p>	<p>Marin Housing Authority</p>	<p>Pending consideration by Marin Housing Authority</p>	<p>Pending consideration by Marin Housing Authority</p>	<p>Pending consideration by Marin Housing Authority</p>	
<p>32. Notes:</p>					

**SECTION 2: ACTIONS FOR IMPLEMENTATION BY OTHER AGENCIES:**

<b>Recommendations</b>	<b>Responsibility</b>	<b>Potential Funding</b>	<b>Priority</b>	<b>Time Frame</b>	<b>Status</b>
33. When Housing Authority waiting lists are open, place public service announcements in English, Spanish, and Vietnamese media.	Marin Housing Authority	Pending consideration by Marin Housing Authority	Pending consideration by Marin Housing Authority	Pending consideration by Marin Housing Authority	
<i>33. Notes:</i>					
34. Collaborate to encourage broader landlord participation in Section 8. Include public outreach program, publicity, variable rent standard, etc.	Marin Housing Authority	Pending consideration by Marin Housing Authority	Pending consideration by Marin Housing Authority	Pending consideration by Marin Housing Authority	
<i>34. Notes:</i>					
35. Assess effectiveness of various approaches to pre- and post-purchase counseling and education for below-market-rate homebuyers.	Marin Housing Authority	Pending consideration by Marin Housing Authority	Pending consideration by Marin Housing Authority	Pending consideration by Marin Housing Authority	
<i>35. Notes:</i>					
36. Fair lending testing and investigations to determine if mortgage lenders are discriminating.	Financial institution regulators; Funders	Will require additional funding	Low	Long Term	

**SECTION 2: ACTIONS FOR IMPLEMENTATION BY OTHER AGENCIES:**

Recommendations	Responsibility	Potential Funding	Priority	Time Frame	Status
<i>36. Notes:</i>					
37. Expand financial literacy and counseling programs.	Fair Housing of Marin; Legal Aid of Marin; Marin Housing Authority; Marin Family Action; Fundors	Will require additional funding	High	Short	
<i>37. Notes:</i>					

K:\Analysis Of Impediments (AI)\AI & Implementation Documents\Analysis Of Impediments - Final Version As Approved By Bos October 11 2011\Implementation Plan (Final Version Approved By Bos Oct 11 2011).Doc/rb