

COMMUNITY DEVELOPMENT AGENCY
PLANNING DIVISION



**MULTI-FAMILY RESIDENTIAL
DESIGN GUIDELINES**

Adopted by the Marin County Board
of Supervisors on December 10, 2013

ACKNOWLEDGMENTS

BOARD OF SUPERVISORS

Susan Adams, District 1

Katie Rice, District 2

Kathrin Sears, District 3

Steve Kinsey, District 4

Judy Arnold, District 5

PLANNING COMMISSION

Katherine Crecelius, At-Large

Ericka Erickson, At-Large

Don Dickenson, District 1

Margot Biehle, District 2

John Eller, District 3

Wade Holland, District 4

Peter Theran, District 5

WORKING GROUP

Bob Hayes

Bruce Burman

John Eller

Steven Aiello

Curry Eckelhoff

Rich Gumbiner

Allan Bortel

Marge Macris

Kathleen Harris

Robert Pendoley

Scott Gerber

Steven Lucas

Sim Van der Ryn

COUNTY STAFF

Brian C. Crawford

Director of Community Development Agency

Thomas Lai

Assistant Director of Community Development Agency

Jeremy Tejirian

Planning Manager of Planning Division

Stacey Laumann

Planner of Planning Division

DYETT & BHATIA

Urban and Regional Planners

Michael Dyett, Principal-In-Charge

Matt Taecker, Principal

Jeannie Eisberg, Senior Associate

Supported by a grant from the Metropolitan Transportation Commission Smart Growth Technical Assistance Program

CONTENTS

INTRODUCTION	1-1
Purpose	1-1
Fundamental Design Principles.....	1-1
How to Use the Guidelines.....	1-2
Organization of Document.....	1-3
2 GENERAL GUIDELINES	2-1
2.1 Community Context.....	2-1
2.2 Proportion, Scale, and Arrangement.....	2-3
2.3 Building and Street Relationships.....	2-4
Building Fronts and Entrances	2-4
2.4 Building Mass.....	2-7
2.5 Building Façades	2-9
General Composition and Rooflines	2-9
Windows	2-10
Materials and Detailing	2-11
Color	2-12
2.6 Outdoor Living Space.....	2-12
Shared, Private, and Publicly-Accessible Open Space	2-12
2.7 Landscaping, Storm Water, and Green Building	2-14
2.8 Exterior Lighting	2-18
2.9 Equipment and Service Areas	2-19
3 PLACE-BASED GUIDELINES	3-1
3.1 Residential Neighborhoods.....	3-1
Context Sensitive Design.....	3-1
Building Scale and Character.....	3-2
3.2 Mixed-Use Centers.....	3-4
Context-Sensitive design.....	3-4
Frontage and Massing	3-5
Commercial-Residential Compatibility	3-7
Horizontal Mixed Use.....	3-7

3.3 Rural Towns	3-8
Context-Sensitive Design	3-8
4 PARKING, STREETS, AND PATHS.....	4-1
4.1 Parking and Vehicle Access.....	4-1
4.2 County-Maintained Streets.....	4-4
4.3 Privately-Maintained Streets.....	4-5
4.4 Trails, Rear Access and Parking Area Lanes.....	4-8
5 DEVELOPMENT PATTERNS	5-1

1

INTRODUCTION

PURPOSE

The Multi-family Residential Design Guidelines provide guidance for achieving high-quality residential design in unincorporated areas of Marin County. The Guidelines are intended to assist project applicants during the project design phase and County staff and decision makers in the review and approval process.

While conformance with the Marin County Code is required for any project approval, these Guidelines offer additional direction about the County's expectations and provide clear evaluation criteria that can be used in decision-making. The Guidelines aim to be prescriptive enough to create a framework for design and to carry out the vision in the Countywide Plan and applicable Community Plans, but flexible enough to allow for creativity and innovation in design. Development applications should achieve general consistency with the guidelines in order to be approved. Competing objectives in the Guidelines will need to be balanced in a manner that is true to the fundamental design principles expressed below.

FUNDAMENTAL DESIGN PRINCIPLES

Marin County goals and policies set the foundation for guidelines in this document. The most relevant goals and policies are synthesized into the following "design principles."

- **Sustainability.** Encourage development patterns and building methods that make efficient use of land, energy and other resources. Build things that last and adapt to new needs over time, including changing environmental conditions such as sea level rise
- **Health and Livability.** Promote public health by making walking and biking attractive options and by encouraging community and other outdoor living areas that are appropriate to the place and the people who will use them.

- **Physical Character.** In each community, respect and enhance essential design characteristics that make it attractive and livable. Protect Marin’s scenic qualities, especially views of ridgelines, hillsides, water, and trees.
- **Housing and Other Human Needs.** Provide a mix of housing types to meet the needs of Marin’s workforce and residents, particularly families, seniors, low-wage earners, and disabled people.
- **Compact Development.** Use Marin’s land efficiently by having new construction take a compact form, whenever possible. Promote infill development within existing communities, consistent with County policy.
- **Fair Housing.** Reduce the potential cost of the County’s development review process for projects that provide homes for people from a broad range of socioeconomic backgrounds by increasing the transparency of design criteria that support approval of such projects in a timely manner.

HOW TO USE THE GUIDELINES

As a first step, applicants should consult the Countywide Plan and any local Community Plan for specific policy measures that pertain to the relevant planning area, land use, and density; and the Marin County Code for site requirements, such as allowable uses, and parking and design standards.

The specific planning process for each project will depend on the zoning requirements, individual features of the project, and physical characteristics of the site. The Guidelines provide direction for how to create high-quality multi-family housing and mixed-use development that will enhance Marin’s character and protect cherished features. Sharing ideas with neighbors, property owners’ associations, and local community groups can be vital for better understanding local conditions and concerns—and should be an early part of the design process. Public engagement at early stages of the design process, and preferably before development applications are filed with the County, should help inform decisions about design of multi-family residential development. These guidelines should be used to accommodate a range of densities in different areas of unincorporated Marin in a context-sensitive manner that leads to more diverse housing opportunities and sustainable communities.

The Guidelines largely address private development and its relation-

ship to neighboring properties and to the public realm, such as how buildings relate to streets. These guidelines do not address architectural topics that are already addressed by existing standards, such as for grading and drainage, “green buildings,” and universal accessibility.

ORGANIZATION OF DOCUMENT

The document is organized into five sections including this introduction.

- **Section 2: General Guidelines** applies to multi-family or mixed-use development projects in all settings and deals with fundamental design and contextual relationships and essential attributes.
- **Section 3: Place-Based Guidelines** addresses considerations associated with distinct yet common types of settings that include the following and are described in guideline DG-2:
 - Residential neighborhoods
 - Mixed-use centers
 - Rural towns

Special site specific conditions, like steep hillsides, may be associated with any one of these general place types and may require flexibility in applying these guidelines.

- **Section 4: Parking, Streets, and Paths** addresses improvements in the public realm, such as sidewalks, crossings, and paths, and also special considerations for parking areas.
- **Section 5: Development Patterns** establishes criteria for several patterns for development that can be used in a variety of settings.

This page intentionally left blank.

2 GENERAL GUIDELINES

The following general guidelines apply to all settings where multi-family residential development might occur in unincorporated Marin County. Guidelines for specific types of places can be found in the following section.

2.1 Community Context

The Multi-family Design Guidelines have been developed to expand housing opportunities within Marin County, while ensuring that multi-family development is built in ways that support a pedestrian-friendly, attractive public realm and the desirable visual and community design characteristics of an area.

DG-1 Regulatory Consistency. Multi-family projects must meet all County Code requirements as well as Federal and State laws. In addition, projects must be consistent with the policies of the Marin Countywide Plan, and, where applicable, the Local Coastal Program and any Community Plan for the local area. Where a guideline conflicts with a regulation in the Marin County Code or a policy in a land use plan, then the regulation or policy shall preempt the guideline.

DG-2 Property Setting. The general guidelines in this section apply in every type of community in the County. Place-based guidelines in Section 3 also apply and are incorporated into the general guidelines. The County will determine which of the settings listed here best describes the physical character of the local context, and which set of place-based guidelines will apply.

- A. *“Residential neighborhoods”* are places where housing is generally the only use. Residential neighborhoods can contain exurban, suburban, or urban densities, or include clustered housing to protect surrounding open space. Most multi-family residential neighborhoods are

“Town life nourishes and perfects all the more civilized elements in man.”
– Oscar Wilde



DG-2: The Multi-Family Design Guidelines will be applied in three different types of settings: residential neighborhoods (top), mixed-use centers (middle), and rural towns (bottom).

in eastern Marin County and relatively close to Highway 101. Residential areas are found at lower densities throughout the County.

- B. “*Mixed-use centers*” are places where retail shops, housing and other local-serving uses come together. Generally, mixed-use centers will be created or enhanced through private redevelopment of predominantly commercial properties in eastern Marin County. Housing may be built above ground-floor commercial as “vertical mixed use,” or housing may be horizontally separate from commercial uses, but connected via streets and paths. Mixed-use projects might be built on smaller parcels, such as along commercial corridors, or on larger sites, such as aging shopping centers where redevelopment makes economic sense.
- C. “*Rural towns*” are places generally located in the western portion of Marin County. Most rural towns contain a core with shops and conveniences surrounded by residential areas, which in turn are surrounded by natural and agricultural land. New buildings in rural towns might be residential or mixed-use, and will have characteristics similar to “residential neighborhoods” and “mixed-use centers.” There are many design attributes unique to rural towns that should be emulated.

In some instances, a particular property will be in a transitional zone between settings or will be used for a special purpose, such as religious institutions or educational institutions, which do not easily fit into any of the three general settings. In these cases, the County will determine the appropriate place-based guidelines to apply or whether a combination of place-based guidelines is most consistent with the fundamental design principles.

These guidelines apply to planning applications for the new development and adaptive reuse of all properties with multiple primary dwelling units on a single lot, as well as to attached single-family dwelling units and condominiums, but they do not apply to floating homes, mobile homes, or farmworker housing. Exceptions to any of the guidelines may be made for adaptive re-use of existing buildings, when strict application of the guidelines would be difficult to attain under the specific circumstances related to the site and existing buildings.

2.2 Proportion, Scale, and Arrangement

The complexion of a place varies with proportion, scale, and arrangement. Proportion is the internal relation of parts while scale is the relation of size to the size of other objects or elements: a street or park, the vast sky, the surrounding landscape, or the observer herself. Proper arrangement is the placement of design elements in a manner that enhances people's experience of the place. In any setting, buildings should be comprised of elements that relate well compositionally, and have features and detailing of comparable to a person's size to provide a sense of human scale.

DG-3 Sense of Enclosure. New buildings should frame street environments and other community open spaces spatially, while respecting the character of scenic and natural resources. Coordinate the size of surrounding buildings with the dimensions of adjacent parks, plazas, paths, streets and other outside areas. The following proportional ratios are encouraged in different place-types:

- A. In mixed-use centers, building walls should ideally be, on average, from one-half to equal the width of the open space enclosed.
- B. In rural towns and residential areas, building walls should ideally be, on average, one-half as high as the width of the open space enclosed.

Regardless of location, a building wall's height should generally not be less than one-fourth of the width of the street environment or community open space being enclosed. The height of the walls should generally not exceed the width of the space they enclose, unless the walls are stepped back to open views of the sky above. Enclosure provided by higher walls should only be used to create a more intimate outdoor room, and in these cases additional amenities or furnishings should be provided to create an inviting social space.

DG-4 Adjacent Spaces and Buildings. The relative cultural and economic importance of adjacent buildings and public spaces should be taken into account when designing new buildings. Buildings occupied by important social institutions such as churches, schools, and other large public institutions should not be visually dominated by new residential developments built next to them. In particular, the scale of historically significant buildings should be respected when designing new projects.



Residential Neighborhood



Mixed Use Center



Rural Town

DG-3: Buildings can create a sense of spatial enclosure along streets. In mixed-use centers (middle), building fronts can form continuous streetwalls and define "outdoor rooms." Residential neighborhoods and residential areas of rural towns are accompanied by a more open sense of enclosure, but building fronts still define the street as an important community space (top and bottom).

DG-5 Sense of Proportion and Scale. New building elements that relate to the size of a person should be used. Include elements such as bays, trellises, horizontal banding, and ornament to provide a sense of human scale. Building elements should visually relate to each other and to the whole building in simple organized ways. Avoid incongruent arrangements, such as when upper floors bear little compositional relationship to the ground floor, or multiple roof forms that do not relate to how the building is organized. The size of openings should generally reflect the size and importance of the associated interior space.

2.3 Building and Street Relationships

How a building or series of buildings relate to the sidewalk and street affects the experience of the pedestrian, bicyclist, or driver passing by. Maintaining continuous street-facing façades and lining streets with active uses or defining elements, such as windows, help to create pedestrian-friendly and visually pleasing places.

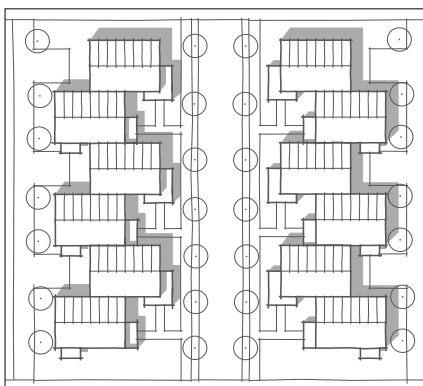
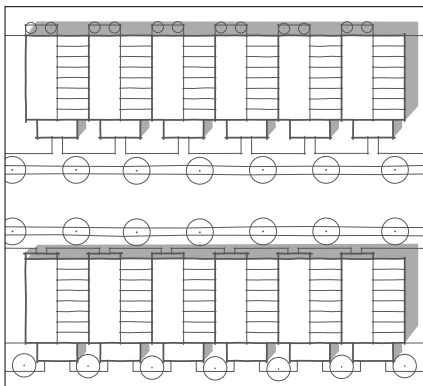

DG-7: An east-west street (above) can allow for south-facing porches, patios and balconies, without using side yards or varying setbacks. Buildings on a north-south street (below) can be staggered to create south-facing walls and outdoor areas.

DG-6 Facing Outward. New development should be designed to promote cohesive neighborhoods. Except when development is clustered to preserve open space, the fronts of buildings should generally face outward toward a neighborhood street.

DG-7 Street-Facing Façades. New building fronts should occupy at least half of a lot's available frontage, except to maintain a pattern of deep setbacks, to have open space, to conserve natural features or to maintain scenic views—such as may be the case in outlying locations. Building fronts should have building entrances and windows, and the presence of blank walls, garage doors, and parking should be minimized.

Street-facing façades should generally parallel the abutting street; solar access to dwellings should also be optimized, while maintaining an appropriate building-street relationship. Flexibility in these standards should be applied to allow for the adaptive re-use of existing buildings (such as re-use of warehouses or motels), to respond to significant site constraints (such as steep slopes or sensitive habitat), and to ensure viable retail configurations in mixed-use centers (such as to provide a site line to major anchor stores).

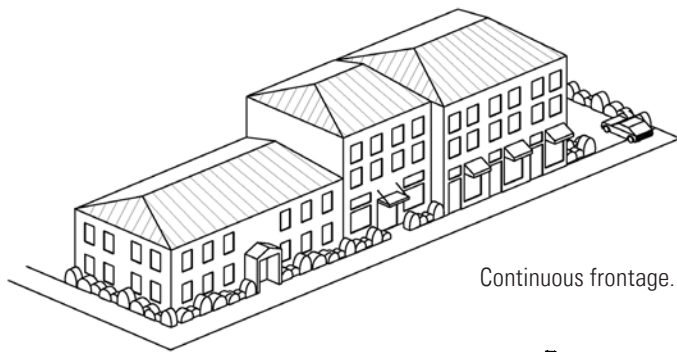

Continuous frontage.

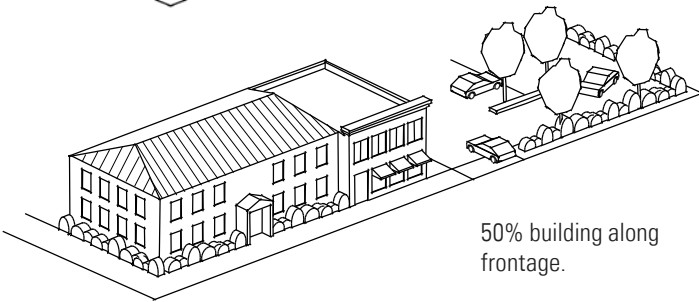

50% building along frontage.

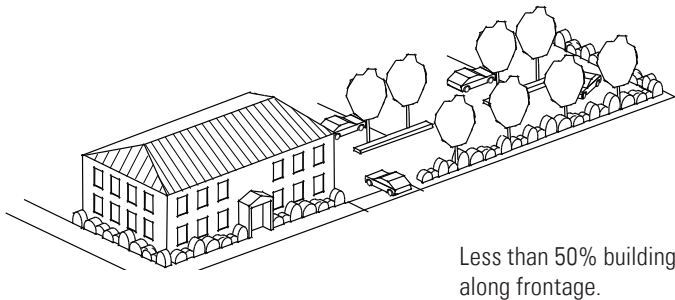

Less than 50% building along frontage.

DG-7: Continuous street-facing building fronts help create more active and visually interesting streets, especially for pedestrians.

DG-8 Building Entrances. Primary building entrances (individual or shared) should be visibly emphasized, architecturally embellished, and accessible from a street and sidewalk to the extent feasible. Entrances that cannot face a public street and sidewalk (such as with especially deep or large lots) should face an internal pedestrian path that connects directly to a street and sidewalk. Internal pedestrian paths may be accompanied by courtyards or plazas. Encourage accessibility by people of different abilities by making it an important design consideration early in the design process.

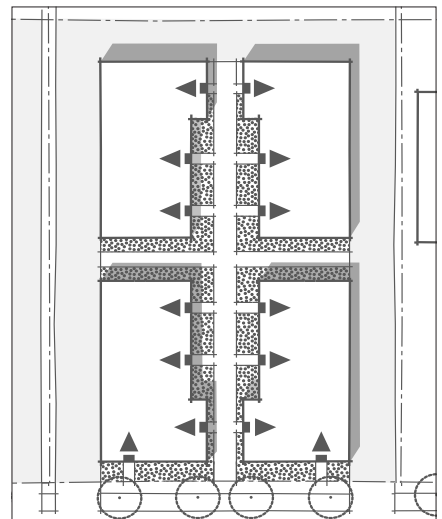
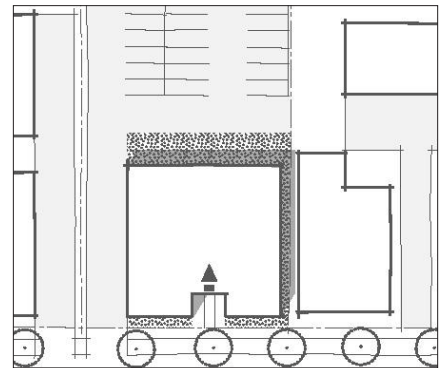
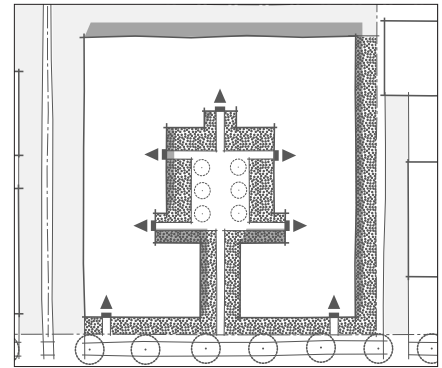

DG-8: When building entrances face streets or face pedestrian paths that connect to streets, continuous and convenient walking routes are created. Courtyards (top), shared yards (middle), and paseos (bottom) use shared open space to connect front doors to the street.



DG-9 Exterior Corridors. Visually prominent exterior corridors that provide access to multiple units on upper floors are discouraged.



DG-10 Front Doors. Front doors (individual or shared) should have a substantial appearance. Avoid flush face doors. Front doors leading to the outside should generally incorporate panels, windows, or be accompanied by adjacent windows so occupants can see out.

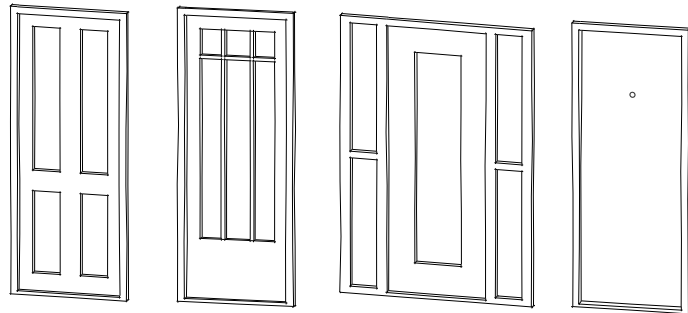

DG-10: Front doors with panels have a substantial appearance, whereas flush face doors (far right) generally do not.



DG-11: Residential entrances can be accompanied by a covered porch, stoop, or veranda to shelter and clearly express the entrance.

DG-11 Porches, Stoops and Verandas. Residential entrances that face streets or pedestrian paths—whether shared or for individual dwellings—should be accompanied by a covered porch, stoop, veranda, or other features that highlight entry points, offer rain protection, and encourage interaction between neighbors. If surrounding development uses such features, use similar roof forms, railings/balustrades and posts/columns. Posts/columns should have a substantial and architectural appearance. Adjacent to the entrance, seating or space for personalized use is encouraged.

DG-12 Universal Design. Universal design refers to the principles and design elements that help meet the needs of all people: young and old, able and disabled. Requirements for compliance with provisions of the Americans with Disabilities Act (ADA) are included in the California Building and Standards Code and other building codes. Multi-family projects should integrate universal design principles into the initial design phase to allow visitability and be barrier free.

For projects that are specific to senior or special needs housing or projects which broadly incorporate principles of universal design, these guidelines may be interpreted more loosely to facilitate design that is appropriate for the designated user.

2.4 Building Mass

A fundamental attribute of all buildings is the size and shape of their volume, which is often referred to by designers as the building's "bulk and mass." The shape of a building's volume can help development blend in. A building's volume can also provide a place-making sense of enclosure by framing adjacent space, as is desirable in mixed-use centers and to transform busy streets into mixed-use boulevards.

DG-13 Context-Sensitive Massing. A building's volume should be shaped differently in different settings, which is generally described here and elaborated upon within the section on "Place-Based Guidelines."

- A. Residential Neighborhoods. A large building's shape should be articulated to reduce the appearance of mass.
- B. Mixed-Use Centers. A building's mass should be built toward streets and plazas to help define these spaces spatially and to create a stronger sense of activity and place.
- C. Rural Towns. Buildings should maintain simple geometric volumes, as are used among traditional styles and vernacular agricultural buildings.

DG-14 Massing on Hillside. On hillside lots with an average slope of 25 percent or greater, the form, mass, profile, and architectural features of the buildings should be designed to visually blend with the hillside setting by taking advantage of existing site features for screening such as tree clusters, depressions in topography, set back hillside plateau areas, and other natural features. Hillside structures should not "stand out" prominently when seen from a distance or from downhill properties. Where feasible, development should avoid highly visible open hillside areas.

The following techniques should be incorporated into the design of hillside residences.

- A. Split pads, stepped footings, or pier and grade beam foundations should be used where geotechnically feasible to permit the structure to "step" to conform to the site's topography. Large single-form structures are discouraged.
- B. Excavate underground or use below grade rooms to reduce effective bulk, while balancing grading to reduce off-haul and the potential for erosion. The visual area of the building can be minimized through a combined use of regrading, landscaping techniques, and color choices.

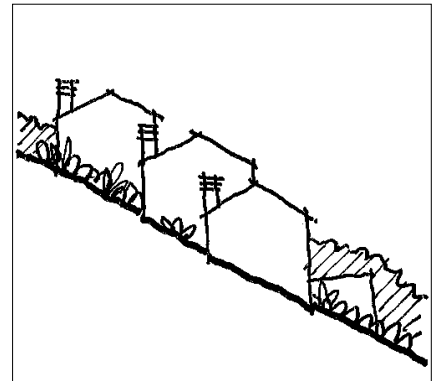

DG- 14: These buildings step down the slope, which helps them appear less prominent.

- C. Large expanses of wall in a single plane on downhill elevations should be avoided. Use horizontal and vertical building components to reduce the visual bulk of hillside residential development. All buildings should have surface relief created by modest overhangs, minor projections, recesses, and plan offsets.
 - D. Downhill placement should minimize front yard setbacks to reduce building mass hanging over the slope.
-

DG-15 Roof Form. Gabled, hipped and shed roof types occur most frequently in residential settings, and may be accompanied by dormers. These roof types can be appropriate in mixed-use settings, as can be flat roofs accompanied by parapets or, in new emerging areas, modern curvilinear expressions.

Eaves should be incorporated into the design to create shadow and serve as a traditional response to Marin's winter rains and summer days with intense sunlight. Deep eaves are encouraged when gabled, hipped and shed roofs are used.

On hillsides, the slope of most of the roof should be oriented in the same direction as the natural slope. Gabled, hip, and shed roof forms at a low to moderate pitch should be used for hillside settings. Moderate overhangs on downhill elevations should be used to create strong shadow lines. Changes in roof pitch orientation should be accompanied by plan offsets on primary elevations. There should be consistency of roof pitch and design among separate roof components. Horizontal plan offsets should accompany abrupt changes in eave heights to make appropriate transitions between building components. Large gable roof ends should not be used on downhill elevations. Terraced decks should not create building bulk when seen from downhill lots.

DG-16 Façade Width. Long building fronts should use "notches" or recesses, change material, compose windows, space chimneys, and/or use other devices to set a rhythm at smaller intervals. Separate fronts with a landscaped side yard or midblock pathway. Building fronts are further limited in some settings, as described under "Place-Based Guidelines."



DG-16: Notches and bay windows break down massing of long façades.

DG-17 Architectural Projections. Bay windows, cornices, and other architectural projections are encouraged except when they would be cantilevered over downward slopes. Do not elevate decks on poles that make buildings seem more massive from the street or surrounding properties.

Incorporate architectural features that support, or appear to support, the weight of architectural projections, such as by using corbels, beam ends, or knee bracing.

2.5 Building Façades

Façade composition can create unified and harmonious buildings, promote distinctive architecture, and encourage visual diversity. New buildings should respond to their particular context to reinforce cherished existing development and/or define new or incomplete areas in positive ways. These guidelines seek to balance Marin's valued settings, while offering more aesthetic freedom in areas that are undergoing transition (such as through the re-use of low-intensity commercial sites).

GENERAL COMPOSITION AND ROOFLINES

DG-18 Base, Middle, and Top. For new buildings that are more than two stories, clearly express a base, middle, and top, as appropriate to a particular building type.

- A. The design of the base should convey its loadbearing function, such as through the use of materials (like stone or stucco) or darker colors, or deep joints in masonry or stucco (i.e., "rustication").
- B. The top creates a prominent visual termination for the building and can add interest through carefully considered roof forms, cornices, eaves, and parapets. Roof pitch, its materials, size, and orientation are all distinct features that contribute to the character of a roof.



DG-17: These photos illustrate how knee bracing, columns and "exposed joists" can "visually support" other building features.



DG-18: These examples illustrate ways to express a base, middle, and top architecturally (top, bottom).



DG-20: Window trim adds to a building's visual interest and appearance.

- C. The middle of a building can be much taller than the base or top, and should have the appearance of being lighter than the base through the use of color and materials (see “Building Façades”).

DG-19 Blank Walls. Avoid long uninterrupted exterior surfaces, including blank walls and garage doors in new buildings. Generally, a street-facing façade uninterrupted by entry doors or windows should not exceed dimensions of 30 feet wide by 20 feet high. If a larger blank wall is needed to make efficient use of a site, improve its design by using recesses, trellises, landscaping, art, display windows (in mixed-use settings), or other visually interesting features. Any façade that can be seen by the public or by neighbors should be designed to be attractive, regardless of which way it faces.



Windows and Entries

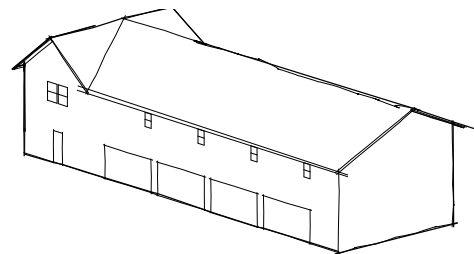

Relatively Blank

DG-19: A façade with windows and entries (top) is compared with a façade that has garage doors and walls that are mostly blank (bottom).

WINDOWS

DG-20 Eyes on the Street. Clear glass windows should face streets, plazas, courtyards and/or pedestrian passages. As a general rule, at least 25 percent of a new street-facing façade should be comprised of windows and fenestration.

DG-21 Privacy. Avoid new windows that face directly into windows of closely neighboring residences, unless they are transom windows, use obscured glass, or landscaping provides screening.

DG-22 Window Quality. Double-hung, awning, or casement type windows are preferred. Window frames should be wood, vinyl, fiberglass, or colored clad metal. Bare metal should not be used except when used intentionally as a modern, industrial, agricultural, or vernacular expression. Glass should be clear and non-reflective, and mirrored glass should not be used. Recess windows from façade or trim to add shadow and visual interest.

DG-23 Traditional Appearance. For traditional appearances, windows should be vertically oriented (i.e., the vertical dimension should exceed the horizontal dimension). Posts may be used to separate windows within wider openings.

DG-24 Climatic Response. In warm and sunny areas of Marin, south- and west-facing windows should be accompanied by light shelves, overhangs, shutters, louvers, deep recesses or other devices that shade the window during the summer and should be designed to allow solar access into the building during the winter. Buildings should be designed and oriented to optimize passive solar heating during winter, while giving emphasis to design guidelines pertaining to street orientation and façade design.

MATERIALS AND DETAILING

DG-25 Durability. Use high quality, durable materials that age well. Materials and applications that will discolor should be avoided.

DG-26 Logic in Application. The edge of veneers should not be obvious, such as by avoiding vertical joints at exterior corners. Generally, lighter materials should be placed above heavier materials (such as wood above masonry, or stucco above masonry).

COLOR

DG-27 Context. Select base colors that blend with the predominant colors and features of surrounding buildings and landscape. Don't detract from buildings in the vicinity, especially if they are designated as architecturally or historically significant. Darker earth tones should be used on hillsides to complement and blend with surrounding vegetation.

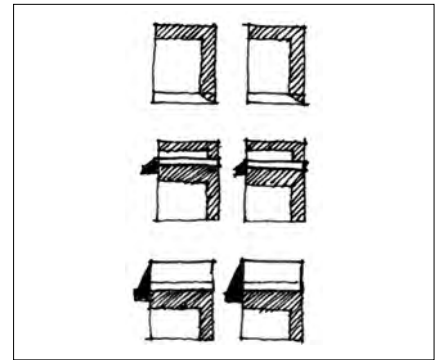

DG-24: Devices for shading building interiors include: deeply recessed windows (top), light shelves (middle), and awnings (bottom). Shading features also add visual interest.

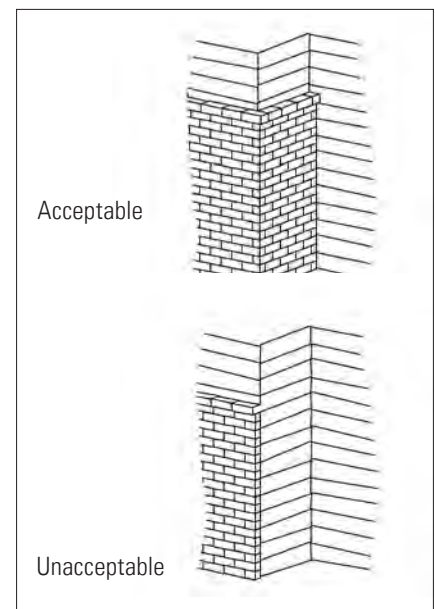

DG-26: These diagrams illustrate how a veneer is less obvious when it wraps around a corner.



DG-30: Shared open space adds amenities and fosters a sense of community. Shared space can include: seating areas (top), play areas (second from top), courtyards (second from bottom), and paseos (bottom).

DG-28 Massing Reduction. Bolder colors should be reserved as accents for building details, ornamentation, or special features to reduce the perceived bulk of structures.

2.6 Outdoor Living Space

Outdoor living space serves an important function, especially given Marin’s benign climate and community-oriented culture. Open space shared among residents, such as courtyards, is essential to connect with the outdoors and promote socializing. Residents also benefit from private open space, such as patios, and residents and the larger community can benefit from publicly-accessible spaces, like plazas and pocket parks.

DG-29 General Provisions. One hundred square feet of shared open space should be provided per unit for new multi-family residential developments. Private open space, such as ground-level patios or upper level balconies, may be used in lieu of required shared open space at a ratio of two square feet of private open space for every one square foot of shared space. Publicly accessible open space with a clear dimension of at least 15 feet and the area enhanced for pedestrian use along “living streets” may be used in lieu of required shared open space at a ratio of one square foot of publicly accessible open space for every two square feet of shared open space.

The property owner, a property owners’ association or other appropriate legal entity should be responsible for managing and maintaining shared open space and publicly accessible open space.

DG-30 Shared Open Space. Outdoor living space for the shared use of residents may include shared lawns, courtyards, community gardens, roof gardens, and play areas. Shared spaces should be accessible to all residents, provide seating areas and some shade, be appropriately lighted, and be designed to encourage social activity. Shared space should be relatively flat and usable.

Shared space should be at least 15 feet clear, with steps and landings to private dwellings allowed within this dimension.

DG-31 Private Open Space. Private open space should have a clear dimension of at least five feet, except to provide built-in bench seating or to use “juliets,” shallow balconies that are at least two feet deep and that are accessible to a living or dining room through French doors. Where it abuts shared or publicly accessible open space, private open space should be separated by a railing, fence, wall, or landscaping. These elements should not be more than four feet in height above grade.

DG-32 Publicly Accessible Open Space. For larger residential and mixed-use projects, open space may be provided that is privately owned but accessible to the public. When included, such privately owned, publicly accessible open space should be provided in locations where high levels of pedestrian and/or community activity can be expected. Publicly accessible open space may include plazas, pocket parks, paseos, and “living streets.”

- A. *Plazas.* Plazas should offer seating and other amenities along shopping streets, at transit stops, and in other urban locations. Plazas should provide appropriate lighting, and use attractive paving and landscaping.
- B. *Pocket Parks.* Pocket parks should be provided within large projects in which children may live. They should be designed to serve surrounding residents and should generally provide a modest lawn, play equipment, shaded areas, trash receptacles, and seating.
- C. *Paseos.* Paseos are midblock passages that reduce walking distances between destinations. Paseos (or a pedestrian path through some other form of publicly-accessible open space) should be used to provide a pedestrian connection across long blocks, which are generally blocks having a length exceeding 300 feet. Paseos should be lined by windows and accompanied by seating, public art or other amenities. Paseos are not necessary where development is clustered and surrounded by protected open space.
- D. *Living Streets.* A “living street” provides significant usable areas for pedestrians and includes high levels of amenity. For more on living streets, see DG-106.

Publicly accessible open space may only be used in lieu of shared open space requirements if:

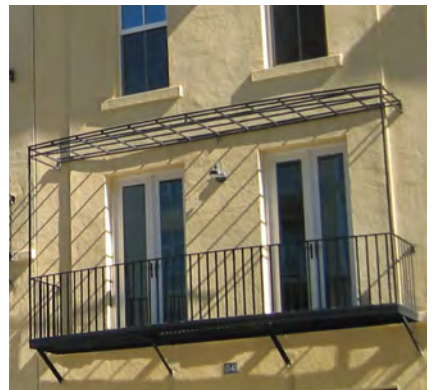

DG-31: Balconies (top) provide private outdoor space. “Juliets” (bottom) open dwellings up to the outdoors without obscuring the façade.



DG-32: Plazas offer seating and other amenities along shopping streets, at transit stops, and other urban locations.

- Shared and/or individual residential entrances are connected directly to it;
- The clear dimension of the open space is at least 15 feet; and
- It is designed for intensive use by residents.

DG-33 Play Areas. In shared and publicly-accessible open space, play structures designed for children should generally be at least 25 percent shaded by tree canopies or structures.

DG-34 Solar Orientation and Scenery. Where possible, locate and design open space to provide:

- A. Views to ridgelines, the ocean or bay, notable historic or architecturally significant buildings, or other scenic features; and
 - B. Access to direct sunlight by residents during most months.
 - C. Whenever practical, design to allow sunshine on 20 percent of the day on the Equinoxes.
-

DG-35 Accessibility. Open space amenities should be accessible to people with disabilities. Seating configurations should generally accommodate people in wheelchairs.

DG-36 Secure Space. To promote their use and enhance safety, shared and privately-owned, publicly-accessible open spaces should include or abut a pedestrian path. They should also be well lighted, have windows looking on and, ideally, frequent building entrances surrounding the space. For publicly-accessible space, provide sight lines into the space. Elevation changes of more than a few feet between the open space and principal pedestrian paths are discouraged.

2.7 Landscaping, Storm Water, and Green Building

Use trees and plants to make attractive and livable places, add and retain economic value, and confer numerous environmental benefits, such as those associated with stormwater quality and eliminating pockets of excessive heat (i.e., heat islands). Landscaping can also influence the way spaces are used, such as to set a boundary between private and public spaces. See “Place-Based Guidelines” for landscaping guidelines for specific types of settings.

DG-37 General Provisions. Use landscaping and related site improvements to promote privacy, reduce off-site visual impacts, and manage storm water while maintaining significant scenic views enjoyed by existing neighbors. Consider the mature height of trees that may be planted.

DG-38 Fence and Wall Materials. The following fence and wall materials are appropriate in all locations except for specific exclusions noted within “Place-Based Guidelines.” Harmonize the color of fences and walls with the natural backdrop, if present.

- Wood;
- Open rectangular-wire fencing on wood posts;
- Iron bar and wrought iron (except in rural towns);
- Open earth tone or green colored wire on wood posts;
- Colored concrete;
- Split-faced concrete block;
- Stone and brick masonry; and
- Framed walls with colored cement plaster finish.

The following wall and fence materials are discouraged:

- Chain link (prohibited in front and corner side yards; allowed along interior lot lines, or if completely covered by planting);
- Corrugated metal;
- Plastic materials (except for color wire); and
- Synthetic materials unless indiscernible from and able to age as well as the natural material it simulates.

DG-39 Appropriate Plants and Water Conservation. Plants selected should be compatible with the climate, geography, and topographic conditions and the project design concept. Where feasible and appropriate, use drought-tolerant plants that require little or no irrigation, and minimize using plants that require pesticides or high levels of maintenance. In wildland urban interface areas, avoid plants that are highly flammable by referring to the Marin County Fire Department’s “no-plant list.” Install native plants where possible, without conflicting with the design of storm water control features or defensible space requirements for fuel reduction.

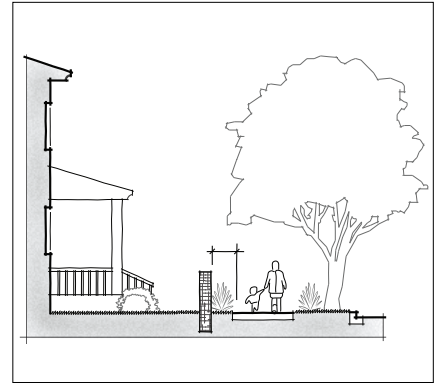

DG-36: A wall that is set behind landscaping runs along a pedestrian path.



DG-39: The plants shown are compatible with the local climate of this project and use less water.

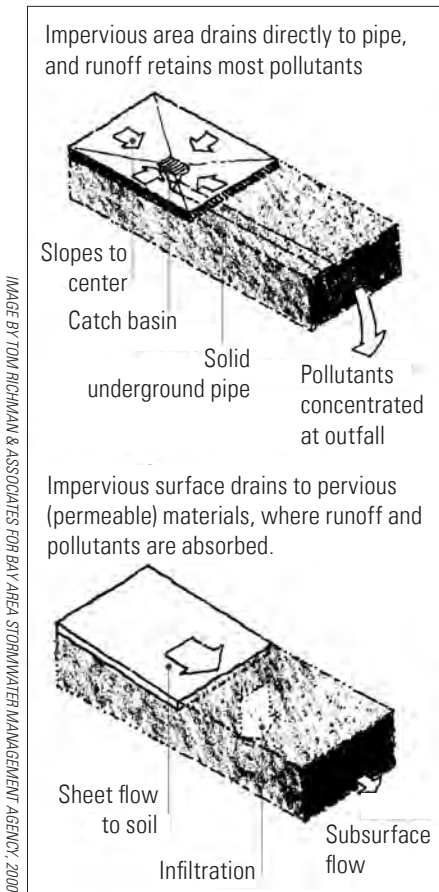

DG-41: “Directly connected pervious areas” (top) convey urban runoff – and associated pollutants – directly to drains, pipes, and water bodies without interruption. With “non-directly connected pervious areas” (bottom), runoff flows to vegetation, pervious paving or other retention feature, as strategies to filter out pollutants.



DG-41: One LID strategy involves the incorporation of bio-retention planter boxes as landscape elements.

DG-40 Trees. Trees planted in private yards should be planted at least five feet from roads and sidewalks. For street trees, see Section 4 on “Parking, Streets, and Paths.”

DG-41 Storm Water Management and Quality. Best management practices for storm water runoff should be incorporated into all multi-family designs, to filter contaminants out of storm water runoff before it reaches our waterways. In addition to complying with the standards of the National Pollution Discharge Elimination System for Low Impact Development (LID), projects should follow LID guidelines under “Place-Based Guidelines” and under “Parking Areas, Streets, and Paths.” The following alphabetical list describes those techniques that are preferred for managing storm water in multi-family residential projects:

- A. *Bioretention Planter Boxes.* A sealed planter box that contains plants and substrate, and has storm water piped into pop-up drainage emitters that distribute water that infiltrates through the soil and drains out at the base of the planter box.
- B. *Cisterns.* Catchment tanks that store rain water collected from impervious surfaces for later use. They typically store 200 to over 10,000 gallons and come in many shapes, sizes, and materials. They may be installed above or below ground or be integrated into buildings.
- C. *Dry Wells.* Below ground cisterns that are porous enough to allow storm water to infiltrate into the ground.
- D. *Green Roofs.* Roofs that are covered with living plants. Some green roofs are highly engineered structural components and can be designed to support park like landscapes useable as open space.
- E. *Infiltration and Retention Basins.* A variety of LID improvements designed to filter pollutants out of storm water by allowing storm water to slowly infiltrate through structured substrate into the ground or storm water sewer system. Some designs may include vegetation.
- F. *Level Spreaders.* Storm water management devices that are designed to uniformly distribute concentrated storm water runoff through a pipe, ditch or swale, by dispersing it as sheet flow over large areas.
- G. *Parking Grove.* A parking lot where run-off runs into tree-lined vegetated swales between rows of parking. Parking groves should use gravel or other pervious surface for

parking stalls, while parking aisles that will be heavily used may be asphalt. Parking stalls may be delineated with contrasting pavers or plantings.

- H. *Pervious Pavement.* Pervious pavements provide a stable load-bearing porous surface that allows storm water to infiltrate into the ground through crevices in the pavement, such as: crushed aggregate or gravel; unit pavers (brick, stone, or cobble stones with porous joints or centers); turfblock; pervious concrete; and pervious asphalt.
- I. *Pop-Up Drainage Emitters.* Emitters that allow water collected from roof gutter downspouts or other storm water collectors to flow through a drainage-pipe away from structural foundations, and “pop up” to disperse in lawn or landscaped areas.
- J. *Rain Barrels.* Above ground catchment tanks that store rainwater collected from impervious surfaces for later use. They typically store between 50 and 200 gallons, and require very little space.
- K. *Rain Catchers and Sunshades.* Multi-purpose structures that can collect and direct rain water into cisterns for detention, infiltration, or reuse. They are highly visible design components and can be used to add vertical elements and visual interest to a project.
- L. *Rain Gardens.* A landscaped depression that takes advantage of rainfall and storm water runoff in its design and plant selection. Storm water is directed into them during the wet season and they are designed to withstand the extremes of moisture and concentrations of nutrients, to increase infiltration of storm water, and to reduce erosion.
- M. *Vegetated Swales.* Narrow, linear depressions designed to capture and convey storm water, which mimics a natural creek by slowing surface water, allowing it to infiltrate, and be filtered.



DG-41: Pervious paving allows infiltration of urban runoff and can provide an attractive design element.

DG-42 Green Building. Incorporate “green building” features that promote energy efficiency, human health, and resource conservation. Projects should incorporate design and construction practices that include, but are not limited to:

- A. Reuse of buildings (whole or portions);
- B. Energy conservation (e.g., daylighted interiors, passive solar, or super-insulation);



DG-42: Roof mounted photovoltaics are integrated architecturally (top). A green roof blends with nearby hills (bottom).

- C. Charging connections for electric vehicles, where appropriate;
- D. Energy generation (e.g., photovoltaics or small wind turbines);
- E. Water conservation (e.g., waterless urinals, rainwater cisterns, or dual plumbing and grey water systems);
- F. Green materials (e.g., reused, recycled or sustainably harvested);
- G. Pedestrian enhancements (e.g., tree-lined sidewalks and making stairways an inviting alternative to elevators);
- H. Green infrastructure measures that treat storm water on site, often as an attractive landscaping feature;
- I. Integrate means of adapting to the effects of climate change, such as sea level rise, into the initial design phase of the project where appropriate; and
- J. Consider ways to allow for future advances in sustainable technology, such as by providing wiring or flexible conduits for installing “smart building” technologies.

For projects that include the adaptive reuse of existing buildings, flexibility in the application of this and other guidelines will be allowed.

2.8 Exterior Lighting

Environments should be designed to encourage pedestrian activity and safety at all hours, while respecting residential neighbors and natural settings. Entryways and areas of high activity should be appropriately illuminated, while minimizing the potential nuisance that lighting might cause neighbors and rural locations.

DG-43 Key Locations. Provide pedestrian-scaled lighting to illuminate entrances, pedestrian paths, or gathering places that may present security concerns (such as paths to parking) and level changes along pedestrian paths.

DG-44 Consistent Design. Lighting should be integral to the design of the building and site, and complement the architectural style of the building. Conceal electrical boxes and conduits from general view.

DG-45 Glare Avoidance. Exterior light fixtures should be mounted at the lowest appropriate height to reduce impacts on neighbors and to preserve natural settings and night sky views. Bollard lighting is encouraged as a way to light pedestrian paths. Lighting on poles should generally not exceed 14 to 16

feet in parking lots and along pedestrian-oriented streets and uplighting should not be used.

- DG-46 Hillside and Natural Settings.** Decorative lighting to highlight a structure or landscape feature (e.g., tree, site retaining wall, etc.) should not be used if it could interfere with the natural appearance of hillsides or open spaces.

2.9 Equipment and Service Areas

Mechanical equipment, refuse containers, storage areas, loading areas, and utilities should be located and designed in a manner that does not interfere with the character of a project's building and landscaping, nor detract from the attractive qualities of surrounding areas.

- DG-47 Unobtrusive Character.** Refuse containers, ground-level equipment and loading areas should be screened from view on at least three sides and be architecturally compatible with surrounding structures. They should be located and designed to be inconspicuous to the extent practical, such as by being located away from streets or integrated into a building's volume.

- DG-48 Utilities.** Utility boxes and transformers should be undergrounded when possible or located away from public sidewalks and other pedestrian pathways and screened from view.

- DG-49 Roof-Mounted Equipment.** Roof-mounted equipment and antennas should not be visible from public view, except for solar panels or wireless facilities that are camouflaged or disguised. Equipment may be recessed within the profile of the building, or screened architecturally, such as through the use of false dormers, parapets or cupolas.

- DG-50 Energy-Generating Equipment.** Solar panels should follow rooflines, and be designed to be less obtrusive while allowing for needed solar access. The location selected for small-scale wind turbines should respect their appearance and views from streets and neighbors.

- DG-51 Noise Attenuation.** Noise generating equipment and activities, such as air conditioning units, condensers, trash compactors, and loading docks, and small-scale wind turbines, should be designed, shielded and located to minimize noise experienced by neighbors.

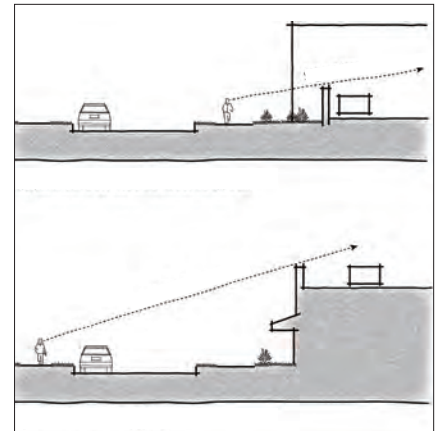

DG-47: Diagrams show how walls and parapets could screen equipment from view.



DG-48: Walls and vegetation screen a utility box (hidden) from view.

This page intentionally left blank.

3 PLACE-BASED GUIDELINES

Marin County has diverse types of places that vary from more urban centers to rural towns. Distinct yet common place types include: residential neighborhoods, mixed-use centers, and rural towns. These place types are described in guideline DG-2. The Multi-family Residential Design Guidelines apply to all of these settings and make distinctions to perpetuate and enhance those characteristics that make each place attractive and livable. The following guidelines supplement the general guidelines by summarizing characteristics essential to each place type and by spelling out place-appropriate design treatments for buildings, outside areas, and development patterns.

“Solutions grow from place.”
—Sim Van der Ryn, *Ecological Design*

3.1 Residential Neighborhoods

Most neighborhoods convey a sense of time and place. Methods of construction, building traditions, and the design preferences of the original builders and subsequent inhabitants, all play a role—as do connections with topography and natural features.

CONTEXT SENSITIVE DESIGN

DG-52 Typical Development Patterns in Residential Neighborhoods. The multi-family development patterns that are most appropriate for residential neighborhoods are listed below.

- A. Small multiplexes (duplexes, triplexes or four unit buildings)
- B. Townhouses
- C. Small and medium sized apartment buildings
- D. Apartment building complexes
- E. Clustered developments
- F. Pocket neighborhoods
- G. Senior and Special needs housing
- H. Living streets

Alternate development patterns may be considered when existing buildings are being converted to residential units or when there are unusual circumstances related to the scale, topography or other physical characteristics of a particular property or neighborhood.

Development patterns are described within Section 5 Development Patterns.

DG-53 Appropriate Finishes. For residential neighborhoods, exterior finishes should be wood, stucco, masonry, native stone, terra-cotta tile, or cement board (e.g., Hardy-board). Metal panels (including corrugated metal), reflective glass, and glass curtain walls should not be used.

DG-54 Appropriate Storm Water Management. When designing a storm water control plan to meet any required LID standards in residential neighborhoods, the following storm water management techniques are encouraged:

- A. Bioretention planter boxes
- B. Cisterns
- C. Dry wells
- D. Infiltration and retention basins
- E. Level spreaders
- F. Parking grove
- G. Pervious pavement (pervious concrete, porous asphalt, brick, stone, turf block, unit pavers)
- H. Pop-up drainage emitters
- I. Rain barrels
- J. Rain gardens
- K. Vegetated swales

Other techniques may also be acceptable due to site specific constraints that make the improvements for the preferred techniques too difficult to install.

BUILDING SCALE AND CHARACTER

DG-55 Consistent Rhythms. For new buildings, entryway spacing, and architectural projections should be used to maintain a similar rhythm and visual continuity with the best examples of what already exists nearby, except when existing building and streetscapes have blank walls, excessively long blocks, or other features that detract from pedestrian-friendly streets. The per-

ceived width of street-facing features should be comparable with existing buildings in the neighborhood, which should be accomplished by using separate buildings or by breaking up the apparent size of bigger volumes with changes in materials, deep recesses, and other changes in vertical plane.



DG-55: This diagram illustrates how new construction can incorporate design elements of similar size, shape, and rhythm.

DG-56 Roof Types. Use roof types similar to what is already used in the surrounding residential neighborhood, if a pattern of similar roof types has been established. Roof forms and roof lines should be broken into a series of smaller building components when viewed from the street to reflect the scale of the neighborhood, site, or hillside setting. Long, linear unbroken rooflines that exceed 50 feet are discouraged. This is especially important in visible hillside locations.

DG-57 Comparable Setbacks. The façade of new buildings should have setbacks that are generally within the range of existing setbacks in the immediate vicinity of the project, except where such setbacks detract from pedestrian-friendly streets.

DG-58 Moderating Bulk. Break development into separate buildings or vary roof heights and vertical planes to reduce the appearance of bulk. As an example, duplexes, triplexes or other small multiplexes may be used to evoke the look of a large single-family residence.

Different materials and colors can also be used to reduce apparent mass. Use subordinate volumes to express entrances, stairwells and other internal functions. Include bay windows, chimneys and other projections. See also DG-16: Façade Width.

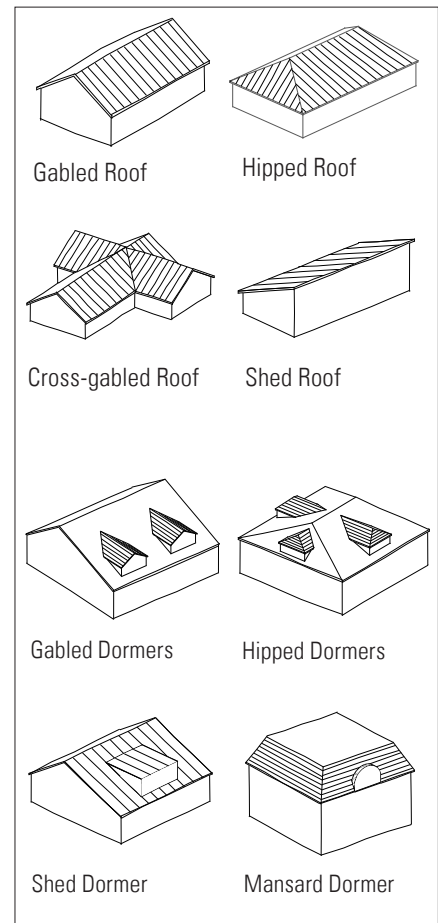

DG-56: These roof and dormer types are common in residential neighborhoods.

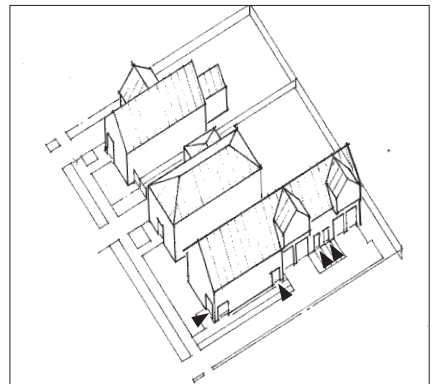

DG-58: Buildings such as this fourplex can be designed to look like large single family homes, especially when at least one entrance faces the street.



DG-58 and DG-59: Changes in horizontal and vertical planes (top), and use of different materials (bottom), can help to reduce the apparent massing and provide visual interest.

DG-59 **Variety.** In both established neighborhoods and new or changing neighborhoods, visual interest should be provided through architectural variety, especially where several new buildings face streets, such as by using different layouts and/or architectural styles. Abutting buildings should have complimentary architectural styles.

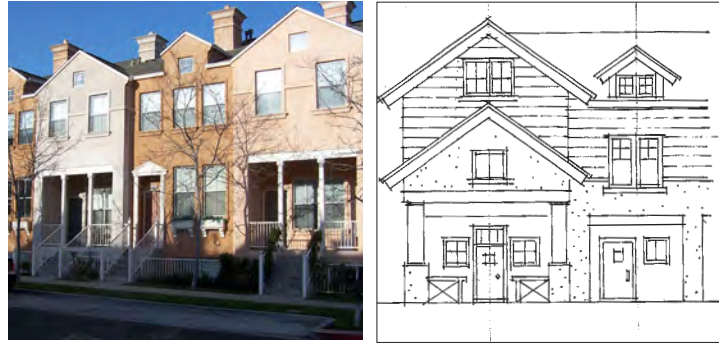

DG-59: Change in plane, porch design, window arrangements, and roof form create visual variety (left). Change in materials and subordinate volumes can help to break up a building's mass (right).

3.2 Mixed-Use Centers

“Mixed-use centers” are places where retail shops, housing and other local-serving uses come together. Live/work arrangements can also contribute to activity and interest within centers. Walking to and within mixed-use centers is critical and should be supported by active and interesting pedestrian environments, as is afforded by “main street” and “boulevard” environments. In these environments, sidewalks can be lined by storefront windows and entries, as well as by amenities and overhead canopies, like awnings. An important positive attribute of main streets and boulevards is the way that buildings frame streets and plazas to create a sense of spatial enclosure, and how residences on upper stories overlook these spaces.

CONTEXT-SENSITIVE DESIGN

DG-60 **Typical Development Patterns for Mixed-Use Centers.** The multi-family development patterns that are most appropriate for mixed-use centers are listed below.

- A. Small multiplexes
- B. Townhouses
- C. Small, medium, and large sized apartment buildings
- D. Apartment building complexes
- E. Vertical mixed-use buildings

- F. Horizontal mixed-use development
- G. Live/work developments
- H. Senior and Special needs housing
- I. Living streets

Alternate development patterns may be considered when existing buildings are being converted to residential units or when there are unusual circumstances related to the site's scale, topography or other physical characteristics of a particular property or neighborhood.

Development patterns are described in Section 5 Development Patterns.

DG-61 Appropriate Finishes in Mixed-Use Centers. Exterior finishes should be limited to wood, stucco, masonry, native stone, terra-cotta tile, metal panels, glass spandrels, or cement board (e.g., Hardy-board). Reflective glass should not be used.

DG-62 Storm Water Management in Mixed-Use Centers. When designing a storm water control plan to meet any required LID standards in mixed-use centers, the following storm water management techniques are encouraged:

- A. Bioretention planter boxes
- B. Cisterns (below ground)
- C. Dry wells
- D. Green roofs
- E. Infiltration and retention basins
- F. Parking grove
- G. Pervious pavement (pervious concrete, porous asphalt, brick, stone, turf block, unit pavers)
- H. Rain catchers/Sun shades
- I. Vegetated swales

Other techniques may also be acceptable due to site specific constraints that make the improvements for the preferred techniques too difficult to install.

FRONTAGE AND MASSING

DG-63 “Main Street” Development Patterns. Along shopping streets—which are often called “main streets”—the integration of housing by placing apartments or live/work lofts

above shops is encouraged. Where there is insufficient market support for retail, space of a public or semi-public nature should front onto sidewalks, such as by using office space, studio space, community rooms, sales offices, and/or business incubator space. Street-facing space may be shallow in order to accommodate ground-level parking or other uses behind it; however, such spaces should be at least 20 feet deep and 15 feet tall to be usable.

DG-64 Commercial Frontage. Requirements in DG-7 should be met, except where flexibility in the design would allow for views from the street toward commercial anchor stores or if viable retail uses cannot be otherwise attained. Along public street edges where retail shops or similarly active uses such as professional offices are viable, street-facing ground-floor space should be comprised of commercial uses or other active public-serving space.

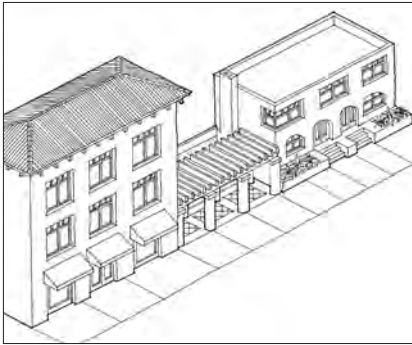

DG-65: In mixed-use centers, continuous street walls can be maintained with storefronts, arcades, and shallow setbacks with entry stoops.

DG-65 Streetwall Continuity. New buildings with street-facing ground-floor commercial or similarly active space should maintain a continuous ground-floor building line along sidewalks, to the extent feasible, except to provide usable open space, a special corner feature, recessed storefront entrances, or a landscaped setback of not more than five feet. Buildings of unique civic or architectural importance need not conform to this guideline.

DG-66 Eye-Level Interest. Because they are experienced at close range, storefronts for new mixed-use buildings should be composed and detailed to enrich pedestrians' visual experience. Create an intimate environment for pedestrians by using quality materials and finishes, careful detailing, and small-scaled elements, such as tile and ornament.

DG-67 Parking. Parking should be screened from the street by landscaping, low walls or fences, or buildings. Locate new parking areas on the side or behind buildings where possible. Below-grade or structured parking that is screened from the street is encouraged for new mixed use development that includes a large apartment building.

DG-68 Framed Outdoor Space. New buildings should maintain relatively continuous building streetwalls in mixed-use centers to spatially define streets and plazas as "outdoor rooms." Projects that form long streetwalls should use multiple buildings that may be of varying height. Accentuate street corners by

varying the building's mass, such as by using taller tower elements or setting the building back to open views and provide seating. Use lower heights or upper-story setbacks to reduce shadow impacts on plazas.

DG-69 Lighting. Building lighting should highlight signs, entrances, display windows, and architectural features of interest. Low-energy lights are encouraged in display windows to allow shop owners to keep display windows lighted in the evening (including after business hours to maintain visual interest and increase security along shopping streets).

DG-70 Awnings, Cornices and Arcades. Separate the commercial ground floor from the upper façade by using a cornice and/or awning which projects horizontally. In established settings, align cornice and other horizontal features with similar features on neighboring buildings.

Commercial entrances facing a street should be recessed or covered by an awning or other canopy. A continuous arcade across multiple entrances may be used instead of awnings.

COMMERCIAL-RESIDENTIAL COMPATIBILITY

DG-71 Service Areas. Employ measures to minimize the impacts that refuse collection and compaction, refrigeration and interior climate control, and loading activities can have on occupants of mixed-use buildings. If possible, locate noise generators away from dwellings, or use a wall and/or roof to contain potential noise.

DG-72 Fumes. Direct exhaust fumes from restaurants and other odor-generating commercial uses away from inhabited space, sidewalks, pedestrian areas, and adjacent residential areas.

HORIZONTAL MIXED USE

DG-73 Mixed-use Arrangement. Mixed-use centers may have blocks that have only residential buildings. Street-facing building configurations with parking on the side or rear are preferred where feasible.

DG-74 Pedestrian Connections. Sidewalks, paths, and paseos should connect residential blocks to commercial uses and amenities. Pedestrian connections should be reasonably direct, landscaped, and have windows overlooking them.

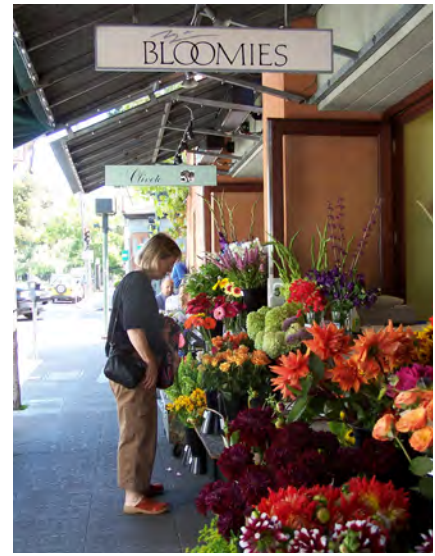

DG-70: Awnings provide shade and define space for commercial activity.

3.3 Rural Towns

Marin County has several rural towns, consisting of relatively intact collections of buildings built in the late 19th and early 20th century. Older buildings in rural towns reflected available resources and building techniques. A hundred years ago, nearly all building materials came from Northern California; mostly wood but also brick and iron. Buildings were comprised of smaller elements because construction was a craft, as plywood and other prefabricated materials had not been invented. Open air porches, deep eaves and recessed windows protect openings from the rain and shade interiors on sunny days.

New development should not distract from the character of rural towns, which residents and visitors appreciate. Rather, new construction should emulate or complement the pattern and scale of older development. At the same time, recognize that rural towns have a range of settings in which different building types can be found. Along “main streets,” general stores with upper story apartments occurred historically and this building form can be successful today as well.

DG-75 Typical Development Patterns for Rural Towns. The multi-family development patterns that are most appropriate for rural towns are listed below.

- A. Small multiplexes
- B. Small and medium sized apartment buildings
- C. Vertical mixed-use buildings
- D. Horizontal mixed-use development
- E. Clustered developments
- F. Pocket neighborhoods
- G. Live/work developments
- H. Senior and Special needs housing
- I. Living streets

Alternate development patterns may be considered when existing buildings are being converted to residential units or when there are unusual circumstances related to the site’s scale, topography or other physical characteristics of a particular property or neighborhood.

Development patterns are described in Section 5 Development Patterns.

DG-76 Appropriate Finishes. In rural towns, appropriate exterior finishes include wood, masonry, and native stone. In commercial mixed-use locations appropriate materials also include cement board (e.g., Hardy-board) and corrugated metal. Flat metal panels, reflective glass, and glass curtain walls should not be used.

DG-77 Traditional Character. New construction should be comparable to established building traditions. Emulate local vernacular traditions of modest and utilitarian buildings, such as those associated with the local agricultural economy or historic town centers.

- A. Use simple building and roof forms consistent with local traditions. A principal volume should be easily discerned, with subordinate volumes added (like porches, stairs, dormers, and rooms) and voids “carved away” (like entry foyers and passages).
- B. Incorporate prevalent building features like porches, verandas, deep eaves, cornices, low fences, and cottage landscaping.
- C. Remain sympathetic to older buildings in the area in terms of materials, the rhythm and proportion of structural bays, color, window and door types, and attention to detailing.
- D. Maintain design integrity and consistency. Avoid false historicism, such as dressing up contemporary buildings with ready-made “historic” fixtures or appurtenances.
- E. Maintain a repetition of roof shape with surrounding buildings for continuity of design.
- F. Structural shape, placement of openings, and architectural details may give a predominantly vertical, horizontal, or non-directional character to a building’s façade. The directional expression of new front elevations should be similar to that of surrounding buildings, and vertical expressions are generally preferred in town centers.

DG-78 Historic Resources. When converting historic buildings or developing new projects in historic districts, the design should respect the historic character of the setting. Each historic building should be recognized as a physical record of its time, place, use, and building culture. Interventions shall not obscure perception of the historical development of the site and interpretive materials should be available to assist the public in understanding the site’s changing character and significance over time.



DG-77: These photos illustrate new construction with traditional roof forms, materials, and massing.

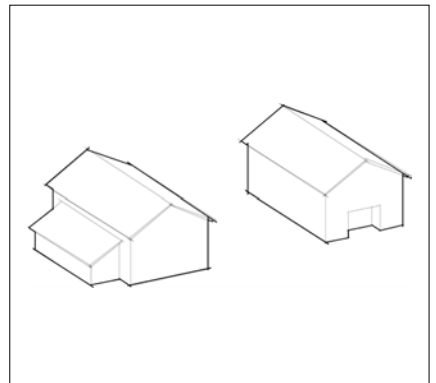

DG-77: Buildings in rural towns are generally comprised of a simple dominant form, with subordinate volumes added (left) or carved away (right).

New additions, exterior alterations, or new construction should be sympathetic to historic materials, features, and spatial relationships that characterize the property. The new work should be in a compatible architectural style and should be: (1) Deferential toward the historic fabric in terms of massing, scale, materials, and architectural features to protect the cultural significance of the site; (2) identifiable as such, so that, aided by suitable interpretative materials, the historic resource may be distinguished from new construction; and, (3) harmonious, avoiding unnecessary contrast with the historic fabric in form or material, to maintain the integrity and character of the site and its context.

DG-79 Storm Water Management in Rural Towns. When designing a storm water control plan to meet any required LID standards in rural towns, the following storm water management techniques are encouraged:

- A. Bioretention planter boxes
- B. Dry wells
- C. Infiltration and retention basins
- D. Level spreaders
- E. Parking grove
- F. Pervious pavement (pervious concrete, porous asphalt, brick, stone, turf block, unit pavers, crushed aggregate/gravel, cobble stones)
- G. Rain barrels
- H. Rain gardens
- I. Vegetated swales

Other techniques may also be acceptable due to site specific constraints that make the improvements for the preferred techniques too difficult to install.

4 PARKING, STREETS, AND PATHS

New improvements should create pedestrian-friendly environments, support new street-level use, and complement the character of surrounding areas. Avoid conflicts between vehicles and pedestrians, and minimize visual and environmental impacts attributable to parking.

Development projects often have an obligation to improve abutting streets and pedestrian paths, which presents opportunities for community enhancement. Trails and sidewalks are essential to promote walking and enhance livability.

4.1 Parking and Vehicle Access

DG-80 Parking Location and Design. Parking lots and garages should not dominate street-facing-façades and should not get in the way of frequent street-facing ground-floor building entrances and windows. Parking should be located on the side or behind buildings or below grade, except in the following circumstances:

- A. Small parking areas located between buildings, screened from public view, and that are not more than 65 feet wide (as measured parallel to the street); or
- B. Garages that face a street and serve individual townhouse or duplex units, or serve small apartment buildings, which have a combined width that is less than half of the street-facing façade of the individual unit or small apartment building.

Parking lots should be at least 25 percent covered with tree canopies after the trees mature. In parking lots, do not plant trees that drop fruit or sap.

As part of an integrated strategy to capture urban runoff, use bioretention areas between parking bays, at the end of parking bays, or at the edge of parking lots. When bioretention areas are used, a reduction in the amount of tree cover may be allowed.

“The best streets will be those where it is possible to see other people and to meet them... Great streets are settings for activities that bring people together.”

*– Great Streets,
Allan Jacobs*

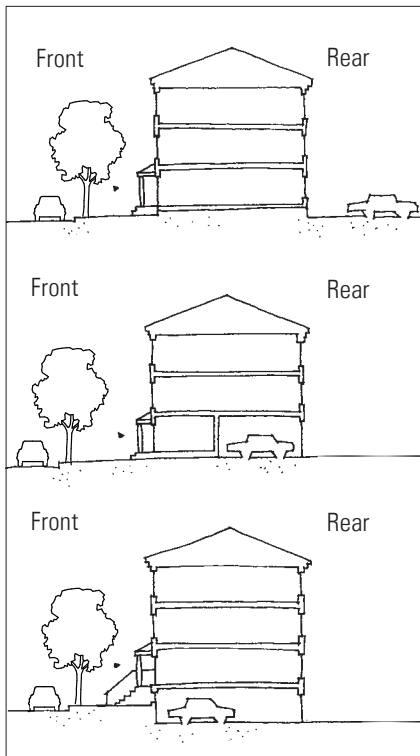

DG-80: Parking can be hidden from the street by placing it behind buildings (top) or below buildings (middle and bottom).



DG-81: Where visible, garage entrances should be recessed and/or accompanied by projecting elements to reduce their prominence.

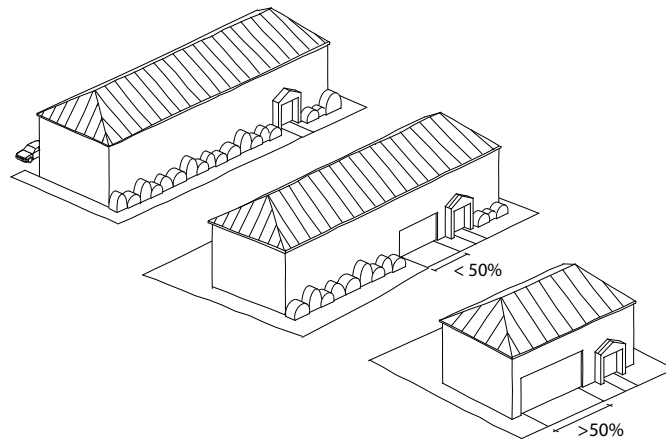

DG-81: When parking and garage doors are in the rear (top), they have no visual impact on the street. When visible from the street, garage doors that take up a smaller share of the façade are visually less prominent (compare middle and bottom).

DG-81 Garage Entrances. The location and orientation of garage entrances (for individual garages or shared parking) should be attractive. Where visible by the public or by other residents, garage entrances should be recessed and/or accompanied by projecting elements like porches, bay windows, trellises, architectural ornament, and/or landscaping. On hillsides exceeding 15 percent slope, garages on upslope sites need not be recessed behind front façades, but in such instances special attention should be given to the design of the garage. The scale of garage doors or gates should be broken down through the use of single-bay garage doors, door panels, windows, and/or trellises.

DG-82 Driveways and Curb Cuts. Avoid excessive pavement and minimize curb cuts, especially along collector and arterial streets. Consolidate vehicular entrances and/or parking access via shared midblock access lane(s), when possible. Consider covered drop off areas for senior citizens, people with disabilities, and carpoolers. When feasible, use pedestrian paths and special pavers to meet requirements for emergency vehicle access while avoiding excessive driveway areas.

DG-83 Access and Parking on Hillsides. Streets, driveways, parking and emergency vehicle access should be aligned to generally conform to existing contours to help minimize grading of slopes and reduce visual impacts. Reduce impacts from parking areas by distributing them, by clustering them in inconspicuous locations, and/or by using garages.

DG-84 Bicycle Parking. Projects should provide conveniently-located and secure bicycle parking. The number of bicycle parking spaces should meet or exceed expected bicycle use, which will vary with location, the age of residents, and other factors. Projects exceeding four new dwellings should also provide a secure bike room and/or bicycle lockers with at least one bicycle space for every two housing units.

DG-85 Transit Amenities. Projects that are next to existing or planned transit stops should provide additional sidewalk space for those waiting to board if needed based on expected ridership. Consider incorporating a small area of covered seating next to transit stops where a shelter is not otherwise provided.

DG-86 Storm Water Management for Parking and Vehicle Access Areas. When designing a storm water control plan to meet any required LID standards in surface (non-structured) parking areas, the following storm water management techniques are encouraged:

- A. Bioretention planter boxes
- B. Dry wells
- C. Infiltration and retention basins
- D. Level spreaders
- E. Parking grove
- F. Pervious pavement (pervious concrete, porous asphalt, brick, stone, turf block, unit pavers)
- G. Pop-up drainage emitters
- H. Rain gardens
- I. Vegetated swales

Other techniques may also be acceptable due to site specific constraints that make the improvements for the preferred techniques too difficult to install.

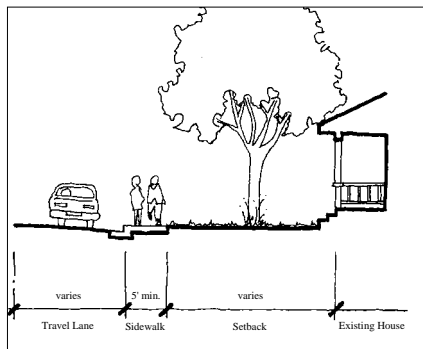

Sidewalk on narrow street

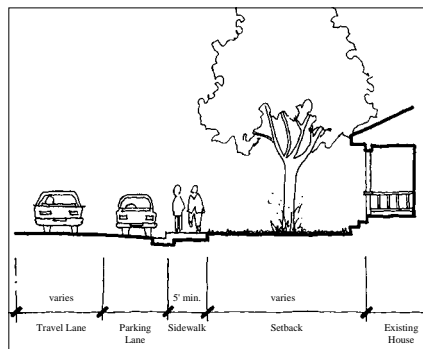

Sidewalk on wider street

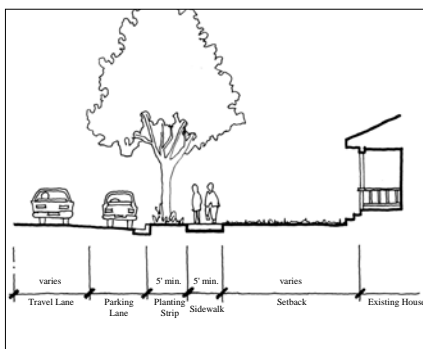

Sidewalk with planting strip

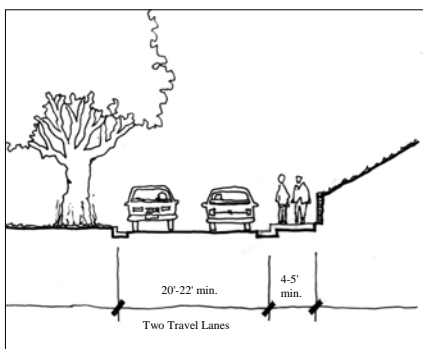

Sidewalk with cut slope and retaining wall

DG- 87: County-maintained street sections. These cross sections provide a guide for the design of county-maintained streets.

4.2 County-Maintained Streets

Projects adjacent to County maintained streets that exceed four units per acre should provide frontage and street improvements that include pedestrian sidewalks or paths. The Guidelines below indicate the preferred designs of required sidewalks, and are consistent with the County's Bicycle/Pedestrian Master Plan. Alternatives to the preferred designs should only be considered when the preferred designs are difficult to attain due to site specific constraints or engineering standards. Landscaping and amenities along a property's frontage and in public rights-of-way should be maintained by the property owner's association for the development.

DG-87 Sidewalks. Sidewalks next to County maintained streets should be developed as indicated below.

- A. *Sidewalks on Narrow Streets.* Figure DG-87 shows the minimal solution for new sidewalks in existing neighborhoods. It shows a site constrained by a small setback to the existing house or significant landscaping and a narrow street condition that does not allow for a parking lane between the pedestrians on the sidewalk and the vehicular travel lane.
- B. *Sidewalks on Wider Streets.* Figure DG-87 demonstrates the preferred design where a lane of parking is between the pedestrian way and the traffic lane. A parking lane is generally preferred for pedestrian safety since it separates pedestrians from moving cars.
- C. *Sidewalk with Planting Strip.* Figure DG-87 illustrates the most desirable condition, for the pedestrian to be buffered from vehicular traffic by both a parking lane and a planting strip. This is particularly important on streets with higher traffic volumes. Ideally, the planting strip should contain street trees at an interval of 20 to 50 feet on center. The trees help to create a more amenable pedestrian corridor and give better spatial definition to the street. This can make the street appear narrower, which helps to slow vehicular traffic.
- D. *Pedestrian Facilities on Constrained Residential Streets.* Some neighborhoods in Marin County have severe constraints that prevent the installation of sidewalks. Such constraints would include the topography immediately adjacent to one or both sides of the street, significant trees or landscape features, small front yard setbacks and/or right-of-way limitations. This section shows various options for addressing pedestrian safety on these streets.

- E. One option, as shown in Figure DG-87, is to install a retaining wall along a hillside in order to provide preferably five feet, but minimally four feet for sidewalk access. Other topographical barriers could be overcome using similar soil retaining methods.
 - F. *Access Ramps.* In many locations in Marin County, corners do not have access ramps conforming to ADA standards. Improvements should be made as monies are available for projects at non-conforming intersections in accordance with applicable standards.
-

4.3 Privately-Maintained Streets

DG-88 Residential Neighborhoods. In residential neighborhoods, new development should provide street improvements that promote walking and improve pedestrian safety. Exceptions may be considered along a public right-of-way fronting a clustered development and in limited circumstances when a site is so constrained that meeting this guideline is impractical. Private streets in front of multi-family residential developments should have—in addition to vehicular travel lanes—a parking lane, a planting strip (or tree well in mixed-use centers), and a pedestrian sidewalk.

Sidewalks, planting strips, and tree wells should each be at least five feet wide. Concrete sidewalks should be provided in most settings, especially along any busy streets. Paths surfaced with compacted decomposed granite are encouraged along streets in relatively level areas that are either rural or have low pedestrian traffic. If decomposed granite is used, header boards should edge the decomposed granite to prevent erosion.

DG-89 Mixed-Use Centers. Sidewalks should be developed along all streets in mixed use centers. Sidewalks should be concrete and at least 10 feet wide, with street trees placed in tree wells at the curb. The 10-foot width provides sufficient space for a five-foot wide throughway and a five-foot wide area for the street trees, light poles, bike stands, and street amenities. On-street parking should be provided, especially where there are shops.

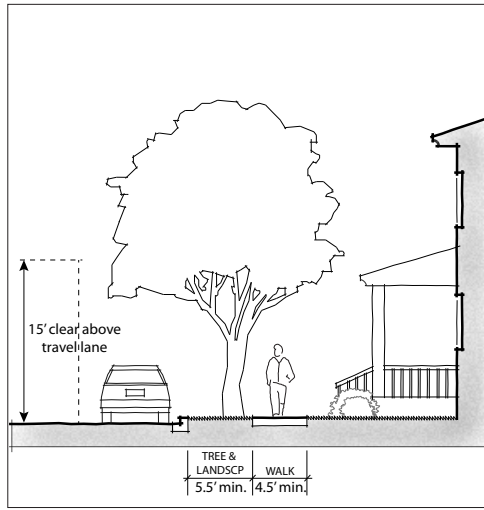

Residential Street (typical)

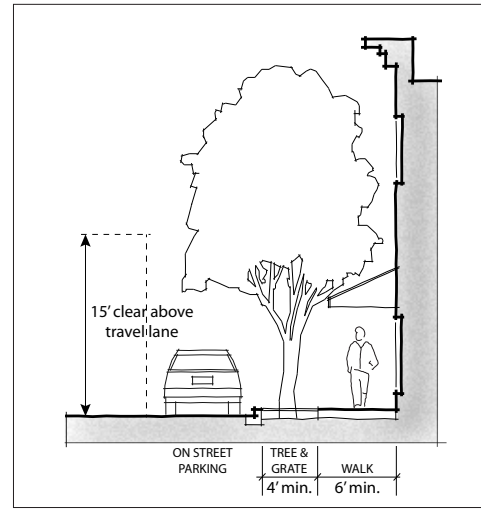

Shopping Street (typical)

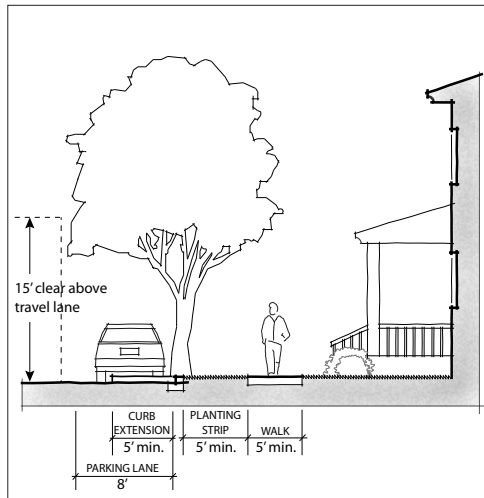

Parking Lane Tree Well

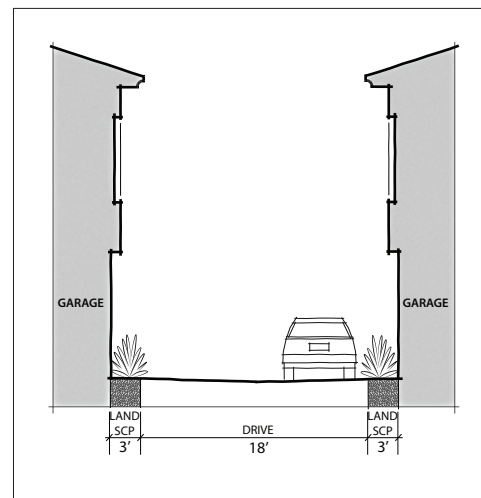

Private Alley

DG 88-94: Privately-Maintained Streets and Access Lanes. These cross sections provide a guide for the design of private streets and access lanes.

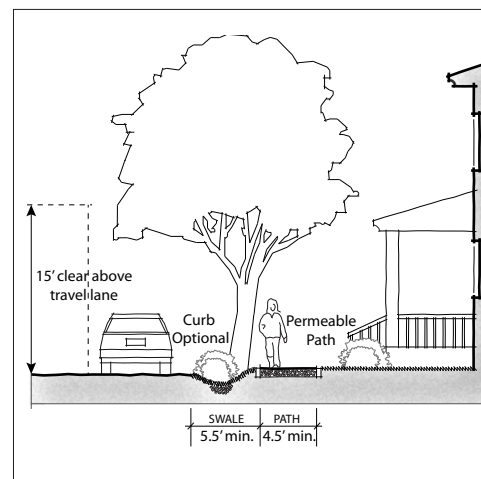

Rural Street (typical)

DG-90 Rural Towns. In rural towns, paths or sidewalks should be developed along all streets in downtown historic districts and along the frontage of properties that exceed a density of four units per acre. Exceptions can be made in limited circumstances when a site is so constrained that meeting this guideline is impractical. Sidewalks should be concrete in mixed use downtown areas and compacted decomposed granite paths should be used in relatively level areas on the outskirts of town. Generally, a planting strip with street trees between the path and the street should be provided and header boards should edge decomposed granite to prevent erosion. Generally, paths should be at least five feet wide and planting strips should be at least five feet wide. On-street parking should be provided except in those circumstances where site constraints make it impractical or unsafe.

DG-91 Parking Lane Tree Wells. Street trees may be planted in tree wells that are in line with on-street parking lanes and combine with a planting strip. The size of the tree well space should be large enough to allow a street tree to be planted five feet on center from the curb and the sidewalk. This strategy can allow larger trees than would be possible in just a five-foot planting strip. Trees that are planted should be large enough to provide a sense of enclosure to the street. Parking tree wells should be spaced at least 40 feet apart to allow at least two 20-foot long parking spaces and located far enough from intersections to avoid obstructing sight distance. In between parking lane tree wells, additional smaller street trees may be grown in planting strips.

DG-92 Street Trees. Appropriate street trees should be chosen with consideration of the local micro-climate, fire hazards, street trees used in the vicinity, their size at maturity, shape and growth habit, root depth, and whether they are evergreen or deciduous. Root barriers, structural soils, and deep soil irrigation methods should be used to avoid roots lifting sidewalks or damaging pavement. Street trees should be spaced such that the canopy of adjacent trees will overlap slightly after the trees have matured.

The location of street trees shall maintain an unobstructed distance of at least 35 feet from a street corner, and should not be planted in other locations where they would obstruct needed sight distance. Property owners' associations should assume responsibility for regular maintenance and pruning of tree limbs to ensure adequate clearance for trucks and emergency access vehicles.

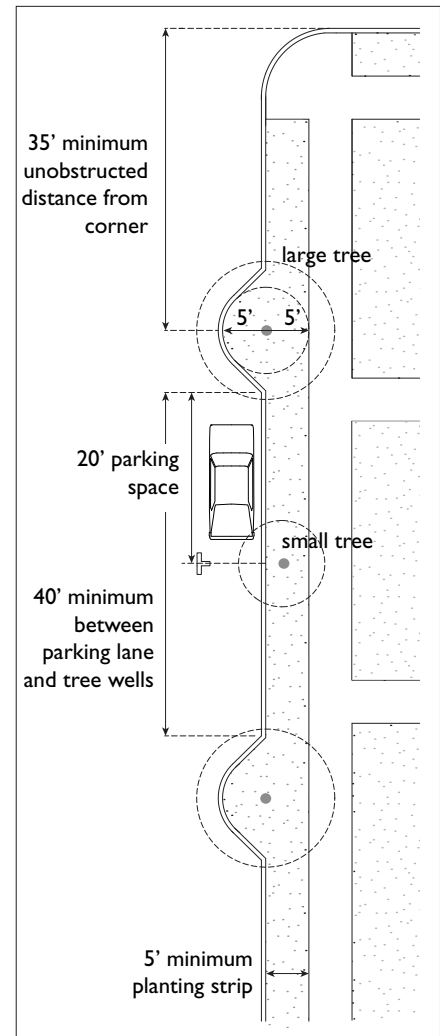

DG 91: Parking lane tree wells allow larger trees with five-foot planting areas, while accommodating vehicles and parking spaces.

DG-93 Curbs, Chicanes and Diverters. At the corners of new intersections, generally use minimum allowable curb radii to bring curbs farther into the intersection and reduce pedestrian crossing distances. In new residential streets, use features such as curb extensions (i.e., bulb-outs), chicanes, and diverters to intentionally meander and slow traffic. In particular, curb extensions should be used at intersections to reduce the distance between sidewalks on opposite sides of the street. Use minimum allowable corner curb radii to slow cars and reduce pedestrian crossing distances between corners, except where a wider radius is needed for emergency vehicles, frequent trucks, or buses.

4.4 Trails, Rear Access and Parking Area Lanes

DG-94 Private Alleys. Rear access lanes, or alleys, offer a way to create street-facing building fronts that are uninterrupted by garage doors, and streetside sidewalks that are uninterrupted by driveways. Where used, the travelled lane should be at least 18 feet wide. A back-up distance of at least 24 feet should be provided between opposing garage doors, or by providing a wider lane, or landscape pavers. A front/back car overhang of at least two feet can be assumed to help maximize ground-cover vegetation. The sides of alleys should be landscaped to the extent possible.

DG-95 Parking Area Lanes. Lanes within parking areas need not provide the pedestrian oriented or other design features called for in these guidelines, but should be compatible with the design features of the project.

DG-96 Access to Public Open Space. Where development abuts a public park or other public open space, a pedestrian path that links the development and the open space should be provided.

5

DEVELOPMENT PATTERNS

Most projects will be comprised of one or a combination of the development patterns described below. Additional guidelines that further define specific development patterns are provided.

DG-97 Small Multiplexes. *Duplexes, triplexes, and quad-plexes are single buildings with up to four units.*

Small multiplexes should be designed to resemble single-family residences, except that they have separate entrances. The units may be side by side or upstairs and downstairs, or back to back if they are on a double-frontage lot. Entrance doors should generally lead from a porch or exterior alcove.

DG-98 Townhouses. *Townhouses are individual housing units with multiple stories that directly abut adjacent multiple story residences. Townhouses are typically 25 to 40 feet in width facing the street.*

Each new townhouse in a row should be designed to be distinctive enough to look like a separate residence. Each townhouse should have its own entry porch or stoop.

DG-99 Apartment Buildings and Complexes. *Apartment buildings have more than four housing units and are distinct from mixed use and livel/work developments in that they are solely residential. Several apartment buildings, arranged around a shared open space, form an apartment complex.*

Apartment buildings fall into the following categories:

- A. Small apartment buildings have less than 15,000 square feet of floor area.
- B. Medium sized apartment buildings have between 15,000 and 25,000 square feet of floor area.
- C. Large apartment buildings have more than 25,000 square feet of floor area.

"[Allow] a building to do what it was meant to do by ordinary means and with a minimum of strain." – Charles Moore, The Sea Ranch Design Manual

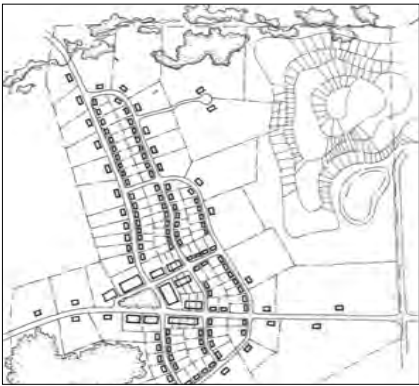
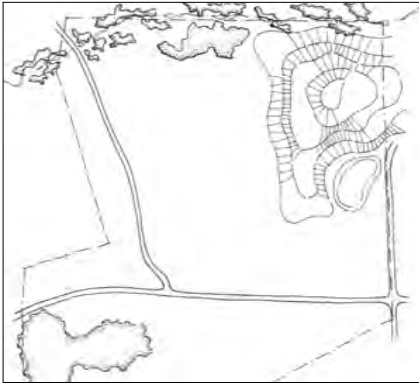

DG-102: Larger sites may have woodlands, steep slopes and other sensitive features (top). The sites can be developed conventionally (middle), or by clustering around sensitive features (bottom).

DG-100 Vertical Mixed-Use Buildings. *Vertical mixed-use buildings have housing units above commercial or institutional space that faces a street or shared pedestrian path.*

The ground-floor of vertical mixed-use buildings should be designed to open to streets and/or pedestrian paths with entrances and windows. Off-street parking should not be located in front of the building, except to meet accessibility requirements. Parking behind buildings should be connected to street-facing building entrances via pedestrian paseos. The residential portion of a vertical mixed-use building should generally conform with guidelines for apartment buildings.

DG-101 Horizontal Mixed-Use Development. *Horizontal mixed-use developments have housing units adjacent to commercial or institutional buildings.*

Residential buildings in mixed-use projects should conform with guidelines for multiplexes or apartment buildings, depending on how large they are and on how many units they contain. Streets and/or pedestrian paths should provide relatively direct connections between residential buildings and community-serving commercial or institutional uses, as well as to streets that abut the project.

DG-102 Clustered Developments. *Clustered developments concentrate development in one particular area or several groupings on a site in a manner that protects a substantial portion of the site from development.*

The design of effective clustered developments begins with identification of natural areas and scenic qualities, and setting aside those portions of the site with high-value ecosystems or agricultural areas. Clustering should generally occur in visually inconspicuous locations, such as where buildings, roads and parking might be screened by existing vegetation, rock outcroppings or topography. New trees and landscaping that are compatible with the natural setting should be used to provide additional screening. On wooded hillsides, relax clustering requirements where a more dispersed development pattern may save trees.

As a general rule, grading and vegetation removal should be minimized to preserve a sense of the natural terrain. Building forms should blend in with existing terrain, such as by breaking up a building's mass, using shed roofs that roughly parallel the slope, and stepping floor levels. Clustered development

can also emulate farms and other vernacular development through the use of simple forms, varied massing and rustic materials.

Paths internal to the project should generally be compacted decomposed granite except where high pedestrian volumes create a need for harder surface sidewalks. A swale to capture and convey storm water should generally abut roadways that do not have a parking lane, and vegetated swales should be included as important organizing elements within the project site plan. Along roadways, paths should be separated by a planting strip. Cluster developments may also incorporate characteristics associated with pocket neighborhoods.

DG-103 Pocket Neighborhoods. *Pocket neighborhoods are clustered groups of residential cottages gathered around common open space with parking in a shared lot adjacent to the cluster of cottages.*

Pocket Neighborhoods should meet the criteria below.

- A. Between 10 and 16 detached residential cottages should be clustered around a common open space area. Larger developments should include several clusters of 10 to 16 cottages.
- B. Each detached cottage should be a single unit or a duplex. Cottages with a single unit should have from 800 to 1,400 square feet of floor area and duplexes may have up to 2,200 square feet of floor area.
- C. The primary entrance to each unit should face toward the interior common open space, except where the building is adjacent to a street. Where a building is adjacent to a street, it should be a duplex with the primary entrance for one unit facing the street and the primary entrance of the other unit facing the interior common open space.
- D. Vehicle parking should be corralled and separated from the front of residences and common open space. Parking areas should generally be located away from streets or located to the side or rear of the cluster in constrained circumstances where the parking can be effectively screened from public view. Surface lots are acceptable, as are multi-vehicle carports or garages.
- E. Common open spaces should be useable as social gathering areas. They should be designed to be at or near the center of the cluster of residences, enclosed by buildings. Paths should connect cottage entrances with each other, with surrounding streets, and with parking areas.

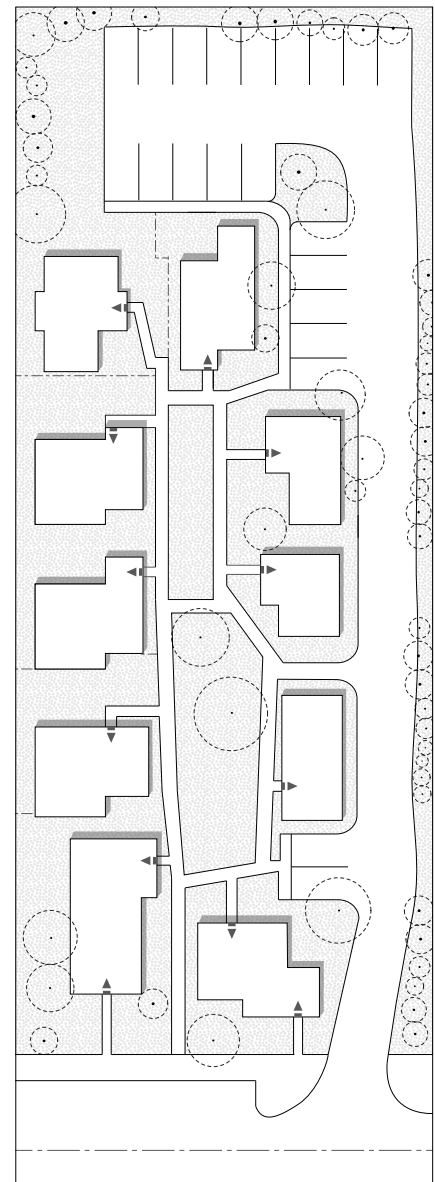

DG-103: Pocket neighborhoods with clustered development and parks provide opportunities for social interaction, furthering a sense of place.



DG-103: A central open space is a defining feature of a pocket neighborhood.

- F. A sequence of physical and implied boundaries should define increasingly private layers of personal space within pocket neighborhoods. Landscape features such as low walkway gates and/or trellises should be used at the entrance to common open spaces to create a sense of arrival at the first boundary. Between the front door of each dwelling and the open space or street that it faces, there should usually be four layers:
- A border of low plantings outside a private yard;
 - A low fence with a gate at the edge of the yard;
 - A privately landscaped yard area between the fence and a porch; and
 - The porch itself. The distance between the common path and the edge of the porch should be at least 10 feet and not more than 20 feet.
- G. Porches should be part of the primary entrance to each residence, connected to the front yard and in full view of the street or a shared walkway. Porches should be large enough for social interaction.
- H. Cottages can be placed close to each other, but they should “nest” together to ensure the privacy of residents. When cottages are located close to each other, one side of a cottage should have an “open face” with large windows facing a side yard with the “closed face” side of a neighboring cottage. The “closed face” side of a cottage should have high windows and possibly skylights or clerestory windows for sunlight. Ideally, open faces of nested buildings should face south or west.
- I. Architectural styles for each cottage within a cluster should resemble the other cottages in the cluster, but custom details should be used for different cottages to add variety.
- J. Clusters of cottages should have either a community building or a community garden or both. Community gardens should provide a small plot to each residence in the cottage pocket. Community buildings should be located centrally or at an important intersection of paths. Community buildings may provide areas for mailboxes, tools, laundry facilities, play and exercise areas, a kitchen and dining areas for common meals, and a shared bicycle storage room.

DG-104 Live/work Developments. *Live/work developments can take two distinctive forms: (1) Live/work buildings in which a residential space is connected to interior workspace; or (2) Live/work courtyards, which have the ground floors mainly dedicated to workspace and have some floor area dedicated to residential space oriented around a central courtyard.*

Typical live/work buildings are more than one story in height and should have commercial or institutional space facing the street. Street-facing entrances to commercial or institutional space should provide generous street-facing windows with commercial displays or views into workspaces. Live/work buildings offer an acceptable way to maintain a continuous shopping street environment, and are of particular value where market support for retail space remains low or unproven but a main street environment is desirable—such as at the periphery of shopping areas.

Live/work courtyards should include a single or multiple buildings that are oriented towards a central common courtyard, except that ground floor work areas may face out toward a street. Common courtyards should be useable as social gathering spaces, attractively landscaped, and should not be used for parking. Courtyards should be designed to be at or near the center of the development, enclosed by buildings and connected to the buildings and parking area by internal walkways. The interior courtyard should be given a sense of enclosure by having the height of the building walls and the dimensions of the courtyard average at least a one to one ratio, except to provide more southern sun exposure to the courtyard.

Between 40 to 70 percent of the total floor area in live/work development should be designed and designated as work space. Spaces in both live/work buildings and live/work courtyards should be designed so that sound exceeding 45 decibels is attenuated, and odors should be minimized so that they do not affect residents.

DG-105 Senior and Special Needs Housing. *Senior and special needs housing is specially designed for senior citizens, disabled people, and other people with special needs. The physical form and design of this housing may vary.*

Housing projects for seniors and people with special needs should be designed in a manner that is most appropriate for the population they are intended to serve. Added emphasis should be placed on universal design, appropriate medical

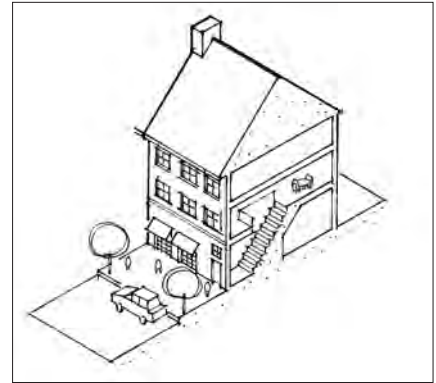

DG-104: Live/work dwellings (top) combine dwellings with at-home office, studio, or shop spaces. The live/work town houses shown (bottom) allow visibility into work spaces at the ground levels and privacy for residential areas at upper levels.

care, and community cohesion. These design guidelines should be applied with flexibility in order to maximize the public benefits these projects provide.

DG-106 Living Streets. *Living streets are publically accessible thoroughfares that create more active, engaging social areas by enhancing the pedestrian realm. When developed along the frontage of a property, they can offset the shared open space requirement for new multi-family projects.*

Living streets should meet the criteria below.

- A. The enhanced pedestrian areas of living streets should be a minimum width of 15 feet or 30 percent of the total width of the right of way, whichever is greater.
 - B. Living streets should have enhanced pedestrian areas that are a minimum length of 100 feet. Road intersections should not bisect this distance, and driveways should be kept to a minimum distance of 60 feet apart if possible.
 - C. The enhanced pedestrian areas of living streets should be clearly separated into four separate zones with the specific minimum widths indicated below:
 - Edge zone—the area between the face of the curb and the furnishing zone (minimum 1.5 feet)
 - Furnishing zone—the area that provides a buffer from the street for pedestrians (minimum five feet)
 - Throughway zone—the walking area (minimum six feet)
 - Frontage zone—area between throughway and building or front property line (minimum 2.5 feet)
 - D. Living streets should use special and coordinated paving, lighting, landscaping and signs.
 - E. The furnishing zone should be decorated with trees and landscaping, and amenities such as swales and water features, public art, benches and tables, water fountains and bike racks.
 - F. The sidewalk and other improvements should be connected and coordinated with improvements on adjacent properties to provide a continuous pedestrian experience.
 - G. On-street parking should be provided in between the edge zone and the travel lanes.
-

DYETT & BHATIA
Urban and Regional Planners

755 Sansome Street, Suite 400
San Francisco, California 94111
☎ 415 956 4300 📠 415 956 7315