

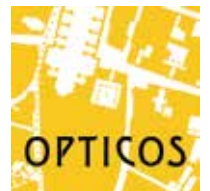

Marin County Form-Based Code

Prepared for:
Marin County, California
December 21, 2022



This page intentionally left blank

Table of Contents

Preamble		1
P-1A	Creating a Place-Based Foundation for Zoning	1
P-1B	Guiding Principles	1
P-1C	Classification of Different Context Types in Marin County	2
P-1D	Summary of the Form-Based Zones in Marin County	4
P-1E	A Form-Based Approach for Marin County	4
P-1F	The Transect	10
Chapter 1: Introduction		11
01.010	Purpose	11
01.020	Applicability	11
01.030	Relationship to the Marin Countywide Plan	15
Chapter 2: Establishment of Zones		17
02.010	Purpose	17
02.020	Zones Established	17
Chapter 3: Zones		19
03.010	Purpose	19
03.020	Overview of Zones	19
03.030	T3 Edge Neighborhood (T3EN)	25
03.040	T3 Suburban Neighborhood (T3SN)	29
03.050	T4 Suburban Neighborhood.Small (T4SN.S)	33
03.060	T4 Core Neighborhood.Medium (T4CN.M)	37
03.070	T4 Suburban Main Street.Small (T4SMS.S)	41
03.080	T4 Core Main Street (T4CMS)	45
03.090	T5 Core Neighborhood (T5CN)	49
03.100	T5 Core Main Street (T5CMS)	53
03.110	Additional Height and Massing Requirements	57

Chapter 4:	General Design Site Standards	59
04.010	Purpose	59
04.020	Screening	59
04.030	Landscaping and Lighting	61
04.040	Parking and Loading	63
04.050	Slope Standards	70
04.060	Public Frontage Standards	76
04.070	Privacy Standards	79
04.080	Environmental Protection Standards	80
Chapter 5:	Specific to Building Types	83
05.010	Purpose	83
05.020	Building Types	83
05.030	Overview of Building Types	87
05.040	Carriage House	89
05.050	House	93
05.060	Duplex Side-by-Side	96
05.070	Duplex Stacked	101
05.080	Cottage Court	105
05.090	Fourplex	108
05.100	Neighborhood Townhouse	113
05.110	Neighborhood Courtyard	117
05.120	Pocket Neighborhood	121
05.130	Multiplex	126
05.140	Core Townhouse	131
05.150	Terraced Courtyard Building	135
05.160	Core Courtyard	139
05.170	Main Street Building	145

Chapter 6:	Specific to Private Frontage Types	153
06.010	Purpose	153
06.020	Private Frontage Types	153
06.030	Overview of Private Frontage Types	154
06.040	Porch Projecting	156
06.050	Porch Engaged	158
06.060	Dooryard	160
06.070	Stoop	162
06.080	Forecourt	164
06.090	Maker Shopfront	166
06.100	Shopfront	168
06.110	Terrace	170
06.120	Gallery	172
Chapter 7:	Specific to Architectural Design	175
07.010	Purpose	175
07.020	Applicability	175
07.030	Architectural Design Standards	175
07.040	Overview of Architectural Styles	175
07.050	Contemporary	179
07.060	Craftsman	191
07.070	Main Street Classical	203
07.080	Mediterranean	213
07.090	Tudor	225
07.100	Victorian	237

Chapter 8: Specific to Large Sites	249
08.010 Purpose	249
08.020 General to Walkable Community Design	250
08.030 Walkable Neighborhood Plan	258
08.040 General to Civic Space	259
Chapter 9: Adjustments	267
09.010 Purpose	267
09.020 Procedures	267
Chapter 10: Definitions	273
10.010 Purpose	273
10.020 Definitions	273
10.030 Measurement Methods	299

This page intentionally left blank

Quick Code Guide for Developments Less Than Three Acres

The following graphic is intended as a summary guide.

1 Determine your Maximum Zoning Envelope ¹		
Identify your zone , see Chapter 3 (Zones)	a. Select your building type(s)	Subsection 3 of the zone
	b. Comply with building placement standards	Subsection 5 of the zone
	c. Comply with building form and height standards	Subsection 4 of the zone
	d. Select from allowed uses	Title 22, Article II
	e. Comply with parking standards	Subsection 7 of the zone
	f. Select your private frontage type	Subsection 8 of the zone
Identify your building type standards , see Chapter 5 (Specific to Building Types)	a. Select your detailed massing type	Subsections 3 and 7 of the building type
	b. Comply with the standards	Subsections 1, 2, 4-7 of the building type

¹ Developments that propose multiple design sites shall apply this process for each design site.

2 Connect Ground Floor to Adjacent Streetscape		
Apply your private frontage type(s) , see Chapter 6 (Specific to Private Frontage Types)	Based on your selected private frontage type(s), comply with the standards	Subsections 1-4 of the private frontage type

3 Design your Building		
Identify your architectural standards , see Chapter 7 (Specific to Architectural Design)	Based on your selected detailed massing type, select your architectural style	Subsections 1-16 of the architectural style

Quick Code Guide for Developments Less Than Three Acres (Continued)

4

Proceed to Adjustments

If adjustments are proposed, see Section 09.020 (Adjustments to Standards)

Meet the required findings to be eligible for the adjustment to the standard(s)

Section 09.020 (Adjustments to Standards)

Quick Code Guide for Developments Over Three Acres

The following graphic is intended as a summary guide.

1 Design your Walkable Neighborhood Plan (WNP)		
Identify your WNP design process , see Subsection 08.020.1	Comply with the standards	Section 08.020 (General to Walkable Community Design)
Prepare WNP	Comply with the standards	Section 08.030 (Walkable Neighborhood Plan)
2 Determine your Maximum Zoning Envelope ¹		
Identify your zone(s) , see Chapter 3 (Zones)	For each WNP:	Subsection 3 of the zone
	a. Select your building type(s)	
	b. Comply with building placement standards	Subsection 5 of the zone
	c. Comply with building form and height standards	Subsection 4 of the zone
	d. Select from allowed uses	Title 22, Article II
	e. Comply with parking standards	Subsection 7 of the zone
Identify your building type standards , see Chapter 5 (Specific to Building Types)	f. Select your private frontage type for each building type	Subsection 8 of the zone
	a. Select your detailed massing type for each building type	Subsections 3 and 7 of the building type
	b. Comply with the standards	Subsections 1, 2, 4-7 of the building type
¹ This process shall be applied to each design site.		
3 Connect Ground Floor of each Building Type to Adjacent Streetscape		
Apply your private frontage types to each building type , see Chapter 6 (Specific to Private Frontage Types)	Based on your selected building types, comply with the standards	Subsections 1-4 of the private frontage type

Quick Code Guide for Developments Over Three Acres (Continued)

4	Design your Buildings		
Identify your architectural standards , see Chapter 7 (Specific to Architectural Design)	Select your architectural style standards for each building type		Subsections 1-16 of the architectural style
5	Proceed to Adjustments		
If adjustments are proposed , see Section 09.020 (Adjustments to Standards)	Meet the required findings to be eligible for the adjustment to the standard(s)		Section 09.020 (Adjustments to Standards)

This page intentionally left blank

Preamble

Sections:

P-1A	Creating a Place-Based Foundation for Zoning
P-1B	Guiding Principles
P-1C	Classification of Different Context Types in Marin County
P-1D	Summary of the Form-Based Zones in Marin County
P-1E	A Form-Based Approach for Marin County
P-1F	The Transect

P-1A Creating a Place-Based Foundation for Zoning

The Form-Based Code or "FBC" implements Marin County's Countywide Plan vision through the application of zones and standards that reflect a context-specific approach based upon Marin County's distinct walkable development patterns. These patterns are described as walkable because of their interconnected streets and blocks; variety of housing choices; and proximity to services, shopping and/or transit. The FBC addresses the walkable development patterns, existing or intended, through standards consistent with Marin's Countywide Plan.

P-1B Guiding Principles

The FBC is guided by the following principles in implementing the Marin Countywide Plan:

1. Across Marin, the FBC:
 - A. Provides clear and effective development standards that allow for streamlined review processes and the predictable production of housing;
 - B. Supports a diversity of housing choices appropriate to their location;
 - C. Ensures appropriately-scaled infill development;
 - D. Reinforces and enhances community design and character in support of the community's vision with: a variety of neighborhoods; main street areas as the cultural and commercial heart of the community; and neighborhoods with centers along pleasant and convenient corridors that interconnect Marin;
 - E. Removes barriers to revitalization and reinvestment through clear, objective, and context-sensitive standards;
 - F. Ensures that each building plays a role in creating a better whole, not just a good building; and
 - G. Promotes development patterns that support safe, effective, and multi-modal transportation options for all users and help reduce greenhouse gas emissions.

2. Within community cores, the FBC:
 - A. Reinforces the main street as a cultural and commercial destination accommodating appropriately-scaled infill housing, mixed-use, and cultural development compatible with existing historic buildings; and
 - B. Facilitates transitions from single-use areas to mixed-use employment centers that are compatible with adjacent residential neighborhoods and public access.
3. Within residential neighborhoods in core, suburban, and edge contexts, the FBC:
 - A. Protects the character of established neighborhoods and builds upon and reinforces the unique physical characteristics of Marin's walkable neighborhoods;
 - B. Supports new walkable neighborhood patterns through new networks of well-designed multi-modal streets that are safe for pedestrians and cyclists; and
 - C. Promotes neighborhoods with quality housing and diverse, context-sensitive housing choices.
4. Along corridors within core, suburban, and edge contexts, the FBC:
 - A. Promotes a variety of housing choices;
 - B. Promotes small local businesses as an important part of Marin's economy;
 - C. Promotes incremental infill and revitalization;
 - D. Reinforces neighborhood main streets as centers to continue as vibrant social and commercial focal points, with services and amenities for the surrounding neighborhoods located within a safe, comfortable walking distance of homes;
 - E. Balances pedestrian comfort and place-making with traffic efficiency; and
 - F. Promotes and accommodates high-quality community design.

P-1C **Classification of Different Context Types in Marin County**

Marin is characterized by different context types that reflect its pre- and post-World War II development patterns. Historic districts and neighborhoods developed prior to WWII tend to be more pedestrian-oriented, with smaller blocks, consistent sidewalks, more integrated development patterns with services, shopping and/or transit within short walking distance. Newer areas of Marin, by comparison, tend to be more auto-oriented, with larger blocks and less amenities within short walking distance.

The FBC applies a context-sensitive approach to Marin that is based upon the classification of three broad context types: Natural, Walkable, and Auto-Oriented Suburban. Each needs to be regulated differently to effectively reinforce the intended context. Figure P-1C-1 (Context Type Descriptions) provides full descriptions of each context type.

Within each of these broad contexts, the FBC further articulates context through three types of areas across Marin: areas at or near the core, suburban areas, and areas at the edge of the community. In order to make as direct a connection as possible between the context-sensitive approach and the standards, this physical structure is carried through into the names of the form-based zones in this FBC.

Figure P-1C-1: Context Type Descriptions

Natural Context

The Natural Context Type consists of land not intended for development. In these areas, nature dominates a person's experience, but may include an occasional recreation-oriented or utility building or other man-made feature. The use of cars occurs, but does not dominate the physical character.

These areas are implemented through conventional, use-based zones.



Auto-Oriented Suburban Context

The Auto-Oriented Suburban Context Type consists of areas developed mainly after the 1950's. This type of development is driven by the priority to accommodate the automobile. Characteristic of this context type, land uses are segregated and often buffered, leaving large distances between them contributing to the need for the automobile for day-to-day functions. Walking and cycling occur in these areas, but generally for recreational rather than destination purposes due to low connectivity and few amenities within short walking distance.

Examples of these areas are commercial big box retail, strip mall centers, single-unit residential subdivisions, and industrial areas.

These areas are implemented through conventional, use-based zones.



Walkable Context

The Walkable Context Type consists of areas where a person can walk, bike or ride transit to work to fulfill most shopping and recreation needs. These areas allow for but do not require the use of a vehicle to accommodate most daily needs.

These areas, primarily developed prior to the 1940's, were developed in a pattern where a person can live with limited reliance on the automobile. Today, these areas are still conducive to destination walking and cycling. These areas are supported through a network of interconnected, tree-lined streets, a diversity of housing choices, and a mix of appropriate commercial and residential uses in a compact form. These areas also support public transit due to their compact nature.

These areas are implemented through the T3-T5 form-based zones.



P-1D Summary of the Form-Based Zones in Marin County

The FBC implements Marin's Countywide Plan through the transect. The transect applies to Natural, Rural, and Walkable Contexts as illustrated in Table P-1E-B (Summary Table of Transects for Natural, Rural, and Walkable Contexts in Marin County). These contexts are implemented through the form-based zones identified in Table P-1F-A (Marin County Transect). See Chapter 3 (Zones) for details of each zone.

P-1E A Form-Based Approach for Marin County

Through this FBC, form-based zoning is applied to Walkable Contexts, as well as to Auto-Oriented Suburban Contexts. The FBC will generate buildings that are scaled to the pedestrian and to existing and future neighboring buildings, and are placed to shape a public realm for pedestrians. While the FBC is intended to generate pedestrian-oriented, walkable development, the prevailing pattern in auto-oriented areas will continue to be a mix of pedestrian-oriented and auto-oriented development unless policy direction for those areas changes to only allow pedestrian-oriented development.

1. What is a Form-Based Code?

Form-Based Coding (FBC) represents a paradigm shift in the way that the built environment is regulated. The formal short definition of a FBC is as follows:

Form-Based Codes foster predictable built results and a high-quality public realm by using physical form (rather than separation of uses) as the organizing principle for the code. These codes are adopted into city or county law as regulations, not mere guidelines. Form-Based Codes are an alternative to conventional zoning.

-Form-Based Codes Institute

Unlike conventional, use-based codes, FBCs utilize the intended form and character, rather than use as the organizing framework of the code. This FBC is informed by the three physical context types described in Section P-1C (Classification of Different Context Types in Marin) to implement the key characteristics that comprise the physical character of different areas (place types) documented across the community. Further, FBCs regulate a series of important elements not just to create a good individual building, but a high-quality place. The terminology in FBCs reflects the intended physical form and hierarchy of different places. For example, instead of a zone being labeled "commercial" or "mixed use," it might be called "main street." The term "main street" ties back to the intended physical form or place, which includes a mix of uses, civic spaces, streets, frontages, and building types that create vibrant walkable urbanism.

It is also important to note that while FBCs primarily regulate the intended physical form, they regulate use secondarily. FBCs allow a range of uses that are carefully chosen to maximize compatibility between uses and the intended physical form of the zone. The use-tables in a FBC are simplified and categorized by use-type, and clearly defined, to allow a greater degree of administrative decision-making related to particular uses.

2. The Natural-to-Urban Transect: The Framework for the Form-Based Code

Most FBCs use an organizing principle called the Natural-to-Urban Transect, see Figure 1 (Transect Diagram). This enables a customized framework of zones for a community that are based on intended physical character.

The transect establishes a hierarchy of physical environments or transects from the most natural to the most urban. The designation of each transect along this hierarchy is determined first by the character and form, intensity of development, and type of place, and secondly by the mix of uses within the area. This hierarchy of physical environments becomes the framework for the entire FBC, replacing use as the organizing principle as in conventional, use-based zoning. Each transect is used to reinforce existing or create new walkable environments.

The Natural-to-Urban Transect is a means for considering and organizing the human habitat in a continuum of intensity that ranges from the most natural condition to the most urban. It provides a standardized method for differentiating between the intentions for urban form in various areas using gradual transitions rather than harsh distinctions. Each transect is primarily classified by the physical intensity of the built form, the relationship between nature and the built environment, and the complexity of uses within the transect.

~ Form-Based Codes Institute

Figure P-1E-1: Transect Diagram

A Natural Transect diagram illustrates a continuum of Natural Context Types from the ocean shore inland from left to right. Image courtesy of DPZ.

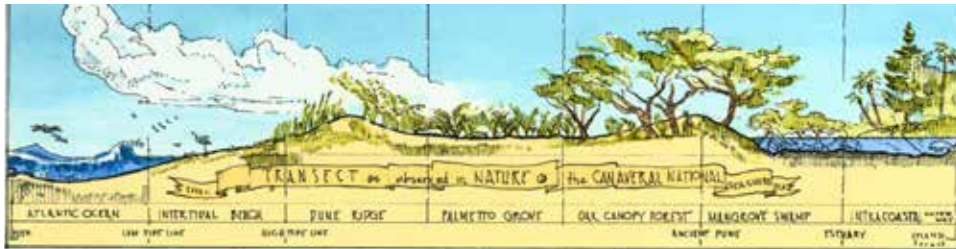

The Natural-to-Urban Transect diagram illustrates a continuum of context types from the most natural to the most urban from left to right. Image courtesy of DPZ.

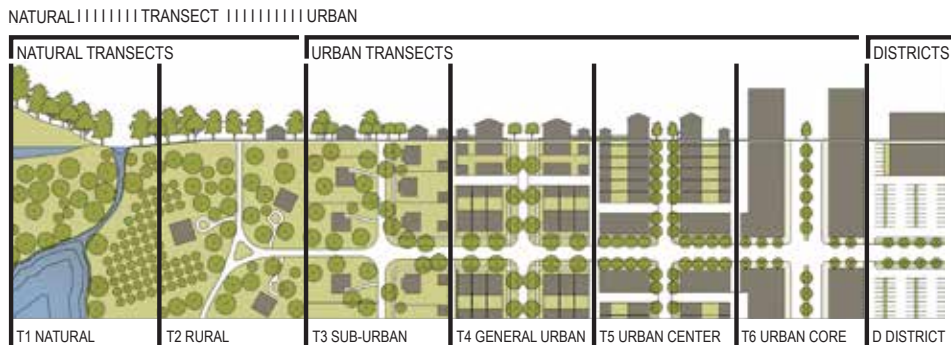

The model transect for American communities is divided into six individual transects and a Special District as shown in Table A (Model Transect for American Communities). Each transect is given a number. Higher numbers designate progressively more urban zones, and lower numbers designate less urban and natural zones. Marin's form-based zones are customized based on this framework.

Table P-1E-A: Model Transect for American Communities	
Transect	Description
T1 - Natural	Lands approximating or reverting to a wilderness condition, including lands unsuitable for settlement due to topography, hydrology or vegetation
T2 - Rural	Sparsely settled lands in open or cultivated state, including woodland, agricultural land, and grassland
T3 - Walkable Neighborhood	Primarily residential with mix of lower intensity building types
T4 - General Urban or Walkable Neighborhood	Primarily residential with mix of moderate intensity building types and some lower intensity centers
T5 - Downtown Center	Higher intensity neighborhoods and higher intensity downtown centers
T6 - Downtown Core	Regional-serving downtown - Not Applicable
D - District	Designation for areas with specialized purposes (e.g., heavy industrial, transportation, harbors, airports or university districts, among other possibilities)

This page intentionally left blank

Table P-1E-B: Summary Table of Transects for Natural, Rural, and Walkable Contexts in Marin County

◀ Less Urban













Natural	Rural	Walkable Contexts
<p>T1</p>  <p>Source: Google Images</p>	<p>T2</p>  <p>Source: Google Images</p>	<p>T3 Walkable Neighborhood</p>  <p>Source: Google Images</p>
		
		
		

Table P-1E-B: Summary Table of Transects for Natural and Walkable Contexts in Marin County (Continued)

More Urban 

Walkable Contexts

T4 Walkable Neighborhood



T5 Downtown Center



T6 Downtown Core

Not Applicable



P-1F The Transect

Table P-1F-A (Marin County Transect) identifies the transects and the form-based zones that implement each transect. Marin's transect includes four of the six individual transects. The form-based zones needed to implement Marin's transect are identified in bold text.

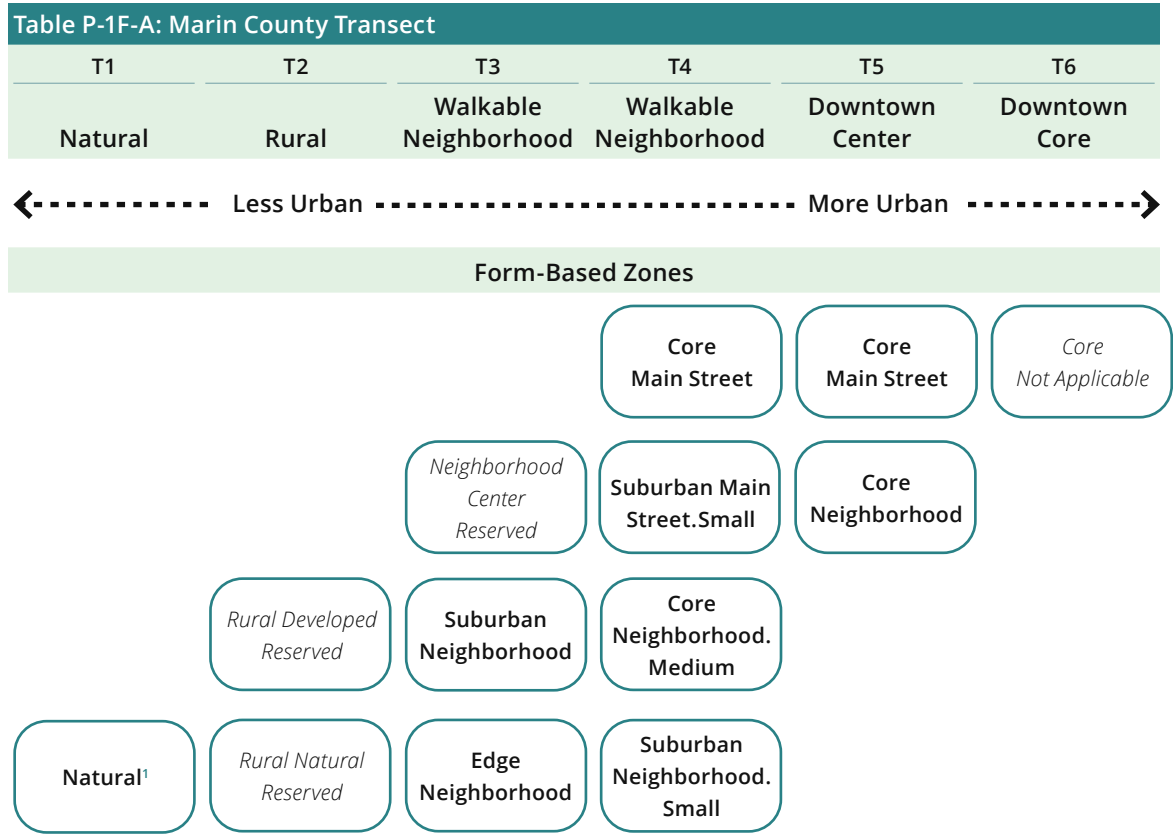

A zone identified as *reserved* denotes a future zone and standards that will need to be prepared when the FBC is applied to areas needing that zone.

¹The T1 Transect is implemented through Open Area zoning district in the Marin County Municipal Code [Chapter 22.14 (Special Purpose and Combining Districts)].

Chapter 1: Introduction

Sections:

01.010	Purpose
01.020	Applicability
01.030	Relationship to the Marin Countywide Plan

01.010 Purpose

This Form-Based Code (FBC) sets forth the standards for neighborhood design, building form, and uses within form-based zones. These standards reflect the community's vision for implementing the intent of the Marin Countywide Plan to facilitate housing production and specifically infill housing production, through development that reinforces the highly valued character and scale of Marin's walkable centers, neighborhoods, and corridors.

01.020 Applicability

1. **Rules for Construction of Language.** The following general rules for construction of language apply to the text of this FBC:
 - A. **Tenses and Numbers.** Words used in the present tense include the future, words used in the singular include the plural, and the plural includes the singular, unless the context clearly indicates the contrary.
 - B. **Applicable.** The applicable standards of this FBC apply so as to not require stating the phrase "and all applicable standards" throughout this FBC.
 - C. **Conjunctions.** Unless the context clearly indicates otherwise, the following conjunctions shall be interpreted as follows:
 - (1) "And" indicates that all connected items or provisions apply;
 - (2) "Or" indicates that the connected items or provisions may apply; and
 - (3) "Either/or" indicates that the connected items or provisions apply singly but not in combination.
 - D. **Abbreviations.** The following terms are abbreviated:
 - (1) Property Line (PL);
 - (2) Maximum (Max.); Minimum (Min.); and
 - (3) Right-of-Way (ROW)

2. **Definitions.** The definitions supporting this Title are in Chapter 22.130 (Definitions)
 - A. For projects subject to this FBC, the standards in this FBC prevail unless stated otherwise.
3. In addition to all applicable federal, State, and county regulations and requirements governing land use and development, the standards in this FBC apply to all proposed development and improvements within form-based zones ("zones") as identified below.
 - A. **General**
 - (1) From the allowed types in the zone, and in compliance with the listed standards, the following shall be selected for each design site:
 - (a) Only one building type per design site is allowed, except a carriage house may be included within a design site in addition to the primary building type. Parcels with enough land area to meet the zone standards for minimum design site width and depth may have multiple building types;
 - (b) The standards of this Title do not regulate density; however, all new or modified buildings shall be in compliance with the maximum allowed density by the Marin Countywide Plan;
 - (c) At least one private frontage type; and
 - (d) At least one use type.
 - (2) Building types and private frontage types not listed in the zone's standards are not allowed in that zone.
 - (3) Uses
 - (a) Comply with Title 22, Article II (Zoning Districts and Allowable Uses) for the underlying zone(s)'s allowed use(s) and permit requirements; and
 - (b) Use types not listed in the underlying zone(s) in Title 22, Article II (Zoning Districts and Allowable Uses) are not allowed in that zone(s).
 - (4) New buildings and their improvements are subject to Marin's local standards for Fire Safety and Building Safety.
 - (5) Marin's standards for Accessory Dwelling Units (ADU) and Junior Accessory Dwelling Units (JADU) apply.
 - (6) New buildings or additions to buildings that result in lot coverage of at least 2,500 square feet shall provide stormwater controls in compliance with Section 24.04.627 (Permanent Stormwater Controls for New and Redevelopment) and BASMAA Manual.

- B. **Site Standards.** See Chapter 4 (General to Design Sites).
- (1) **Screening.** The standards of Section 04.020 (Screening) apply to the following:
 - (a) All new development; and
 - (b) Improvements to existing development.
 - (2) **Landscaping and Tree Standards.** The standards of Section 04.030 (Landscaping and Lighting) apply to the following:
 - (a) New primary building(s); and/or
 - (b) Site improvements to existing development.
 - (3) **Parking and Loading.** The standards of Section 04.040 (Parking and Loading) apply to the following:
 - (a) New development;
 - (b) Changes in land use; and/or
 - (c) Changes in intensity of buildings or structures made after the effective date of this FBC that cause any increase in:
 - i. Gross floor area;
 - ii. Seating capacity;
 - iii. Units; and/or
 - iv. Parking spaces.
 - (4) **Slope Standards.** The standards of Section 04.050 (Slope Standards) apply to portions of design sites with grades of six percent or more.
 - (5) **Public Frontage Standards.** The standards of Section 04.060 (Public Frontage Standards) apply to existing and proposed streets, in any of the following situations:
 - (a) New primary building(s);
 - (b) Addition(s) over 50 percent of the existing floor area of primary building;
 - (c) Facade renovation(s) to primary building along front or side street; and/or
 - (d) New block(s).
 - (6) **Privacy Standards.** The standards of Section 04.070 (Privacy Standards) apply to existing and proposed streets, in any of the following situations:
 - (a) New primary building(s);
 - (b) Addition(s) over 50 percent of the existing floor area of primary building; and/or
 - (c) Facade renovation to primary building along interior side design site line.
 - (7) **Environmental Protection Standards.** The standards of Section 04.080 (Environmental Protection Standards) apply to all development.

- C. **Building Type Standards.** The standards of Chapter 5 (Specific to Building Types) apply to the following:
 - (1) New buildings (except public safety buildings); and
 - (2) Additions (except public safety buildings).
- D. **Private Frontage Type Standards.** The standards of Chapter 6 (Specific to Private Frontage Types) apply to the following:
 - (1) New buildings;
 - (2) Building facade renovation facing a street or civic space (except public safety buildings);
 - (3) Private property improvement along front or side street; and
 - (4) Modification of pedestrian entrance(s) along front or side street.
- E. **Sign Type Standards.** Comply with the standards established in Chapter 22.28 (Signs).
- F. **Architectural Design Standards.** The standards of Chapter 7 (Specific to Architectural Design) apply to the following:
 - (1) New buildings; and
 - (2) Building facade renovations that propose a change to any of the following: wall finishes, window trim finishes, roof materials, size of opening(s), architectural detail(s). The standards of Chapter 7 (Specific to Architectural Design) shall only apply to those elements being changed (except public safety buildings).
- G. **Walkable Community Design**
 - (1) **New Development.** New development on a design site of at least three acres or at least 700 feet long or deep is required to be designed in compliance with Chapter 8 (Specific to Large Sites).
 - (2) **Blocks and Streets**
 - (a) Development sites larger than three acres or at least 700 feet long or deep shall be divided into new blocks in compliance with Subsection 08.020.6.
 - (b) New streets are required to form blocks in compliance with Table 08.020.A (Block Size).
 - (c) When designing a new street or retrofitting an existing street, the standards in Title 24.02(l) (Roads) apply.
 - (3) **Design Sites**
 - (a) New buildings are required to be designed in compliance with the design site width and depth standards of the zone.
 - (b) This FBC does not require the recordation of design site lines. The design site width and depth standards are for the purpose of consistently achieving pedestrian-oriented and scaled buildings.
 - (4) **Civic Space Type Standards.** Development sites larger than three acres are required to create new civic space(s) in compliance with the standards of Chapter 8 (Specific to Large Sites) and Section 08.040 (General to Civic Space).

- H. **Street Standards.** The standards of Title 24.02(I) (Roads) apply to the following:
- (1) The construction of a new street and/or when an application for a Walkable Neighborhood Plan (WNP) is proposed.
 - (2) Existing street(s):
 - (a) Improvement or modification to curb return, pedestrian crossing, landscaping, or sidewalk;
 - (b) Improvement or modification to on-street parking, or lane striping; and/or
 - (c) Improvement or modification to right-of-way.
- I. **Nonconforming Situations.** The standards of Title 22.112 (Nonconforming Structures, Uses, and Lots) apply to all nonconforming situations.
- J. **Procedures.** Requests for administrative relief are to be processed in compliance with the required findings in Section 09.020 (Adjustments to Standards).

01.030 Relationship to the Marin Countywide Plan

This FBC implements state laws requiring ministerial review of by-right housing developments. The FBC is constructed to implement the Marin Countywide Plan through a palette of form-based zones described in Chapter 2 (Establishment of Zones).

This page intentionally left blank

Chapter 2: Establishment of Zones

Sections:

- 02.010 Purpose
- 02.020 Zones Established

02.010 Purpose

This Chapter establishes the palette of form-based zones ("zones") to implement the Marin Countywide Plan, and its transect as described in the Preamble of this FBC. The zones are for the purpose of generating and supporting the variety and physical character of existing and new walkable environments.

02.020 Zones Established

1. This Section identifies the zones, based on the intended physical form and character of the environments described in the Preamble of this FBC. These zones focus on mixed-use, walkable environments and range in function and intensity from primarily residential areas with a mix of lower intensity building types (T3 Edge Neighborhood and T3 Suburban Neighborhood), to moderate intensity neighborhoods (T4 Suburban Neighborhood.Small), moderate-intensity centers (T4 Suburban Main Street.Small and T4 Core Main Street), to higher intensity neighborhoods (T4 Core Neighborhood.Medium and T5 Core Neighborhood) and higher intensity centers (T5 Core Main Street).
2. The Main Street zones (T4 Suburban Main Street.Small, T4 Core Main Street, and T5 Core Main Street) shall be applicable only when the underlying zoning is commercial.

This page intentionally left blank

Chapter 3: Zones

Sections:

03.010	Purpose
03.020	Overview of Zones
03.030	T3 Edge Neighborhood (T3EN)
03.040	T3 Suburban Neighborhood (T3SN)
03.050	T4 Suburban Neighborhood.Small (T4SN.S)
03.060	T4 Core Neighborhood.Medium (T4CN.M)
03.070	T4 Suburban Main Street.Small (T4SMS.S)
03.080	T4 Core Main Street (T4CMS)
03.090	T5 Core Neighborhood (T5CN)
03.100	T5 Core Main Street (T5CMS)
03.110	Additional Height and Massing Requirements

03.010 Purpose

This Chapter provides zones and standards to implement state housing laws and the Marin Countywide Plan to generate and support the variety of physical character of the intended development.

1. The design site size standards for each building type are set in each zone to generate pedestrian-oriented buildings within the overall intended physical character of each zone. The design site size standard identifies the range of design site sizes on which the given building type is allowed to be built.
2. See underlying zoning for allowed uses.
3. New development, except for necessary roadways, bridges, and utilities, shall not be located in stream conservation areas or wetlands conservation areas.
4. Certain building types have additional standards beyond the zone standards to further calibrate the type for its context.

03.020 Overview of Zones

Table A (Zones Overview) provides an overview of each zone and its intent. This information is to show how the broader transects in Table P-1F-A (Marin County Transect) have been applied, and as qualitative background information on the intended physical character, allowed range of uses, and direction for the detailed standards in each zone.

Table 03.020.A: Zones Overview

◀ **Less Urban**

T3 Edge Neighborhood 03.030



Zone Abbreviation

T3EN

Sub-Zone(s)

None

Intent

A walkable neighborhood environment of small-to-medium footprint, low-intensity housing choices, supporting and within short walking distance of neighborhood-serving retail and services.

Desired Form

House-Scale Buildings

Detached Buildings

Small-to-Medium Building Footprint

Medium-to-Large Front Setbacks

Medium-to-Large Side Setbacks

Up to 2.5 Stories

House, Duplex Side-by-Side, Fourplex, Pocket Neighborhood, and Terraced Courtyard Building

Porch Projecting, Porch Engaged, and Dooryard Frontage Types

T3 Suburban Neighborhood 03.040



Zone Abbreviation

T3SN

Sub-Zone(s)

None

Intent

A walkable neighborhood environment of small-to-medium footprint, low-to-moderate-intensity housing choices, supporting and within short walking distance of neighborhood-serving retail and services.

Desired Form

House-Scale Buildings

Primarily Detached Buildings

Small-to-Medium Building Footprint

Small-to-Medium Front Setbacks

Small-to-Medium Side Setbacks

Up to 2.5 Stories

House, Duplex Side-by-Side, Cottage Court, Fourplex, Neighborhood Townhouse, Pocket Neighborhood, and Terraced Courtyard Building

Porch Projecting, Porch Engaged, and Dooryard Frontage Types

Table 03.020.A: Zones Overview (Continued)

T4 Suburban Neighborhood.Small 03.050



Zone Abbreviation

T4SN.S

Sub-Zone(s)

None

Intent

A walkable neighborhood environment of small-to-medium footprint, moderate-intensity housing choices, supporting and within short walking distance of neighborhood-serving retail and services.

Desired Form

House-Scale Buildings
 Primarily Detached Buildings
 Small-to-Medium Building Footprint
 Small-to-Medium Front Setbacks
 Small-to-Medium Side Setbacks
 Up to 2.5 Stories
 House, Duplex Stacked, Cottage Court, Fourplex, Neighborhood Townhouse, Neighborhood Courtyard, Pocket Neighborhood, Multiplex, and Terraced Courtyard Building
 Porch Projecting, Porch Engaged, Dooryard, and Stoop
 Frontage Types

T4 Core Neighborhood.Medium 03.060



Zone Abbreviation

T4CN.M

Sub-Zone(s)

None

Intent

A walkable neighborhood environment with medium-to-large footprint, moderate-intensity housing choices, supporting and within short walking distance of neighborhood-serving retail and services.

Desired Form

Primarily House-Scale Buildings
 Primarily Detached Buildings
 Medium-to-Large Building Footprint
 Small Front Setbacks
 Small Side Setbacks
 Up to 3.5 Stories
 House, Neighborhood Courtyard, and Multiplex, Terraced Courtyard Building
 Porch Projecting, Porch Engaged, Dooryard, Stoop, Shopfront, and Terrace Frontage Types

Table 03.020.A: Zones Overview (Continued)

T4 Suburban Main Street.Small 03.070



Zone Abbreviation

T4SMS.S

Sub-Zone(s)

None

Intent

A walkable, vibrant district of small-to-medium footprint, moderate intensity, mixed-use buildings and housing choices, supporting neighborhood-serving ground floor retail, food and services.

Desired Form

Primarily House-Scale Buildings

Primarily Attached Buildings

Small-to-Medium Building Footprint

None-to-Small Front Setbacks

None-to-Small Side Setbacks

Up to 2.5 Stories

House, Neighborhood Townhouse, Neighborhood Courtyard, Multiplex, and Main Street Building

Porch Projecting, Porch Engaged, Forecourt, Shopfront, Terrace, and Gallery Frontage Types; Dooryard, Stoop, and Maker Shopfront Frontage Types on Side Street

T4 Core Main Street 03.080



Zone Abbreviation

T4CMS

Sub-Zone(s)

None

Intent

A walkable, vibrant district of medium-to-large footprint, moderate intensity, mixed-use buildings and housing choices, supporting neighborhood-serving ground floor retail, food and services.

Desired Form

Block-Scale Buildings

Primarily Attached Buildings

Medium-to-Large Building Footprint

None-to-Small Front Setbacks

None-to-Small Side Setbacks

Up to 4 Stories

Multiplex, Core Townhouse, Core Courtyard, and Main Street Building

Forecourt, Shopfront, Terrace, and Gallery Frontage Types; Dooryard, Stoop, and Maker Shopfront Frontage Types on Side Street

Table 03.020.A: Zones Overview (Continued)

More Urban 

T5 Core Neighborhood 03.090



Zone Abbreviation

T5CN

Sub-Zone(s)

None

Intent

A walkable neighborhood environment of large footprint, high-intensity housing choices supporting and within short walking distance of neighborhood-serving retail and services.

Desired Form

- Block-Scale Buildings
- Primarily Detached Buildings
- Large Building Footprint
- Small Front Setbacks
- Small Side Setbacks
- Up to 5 Stories
- Multiplex, Core Townhouse, Terraced Courtyard Building, and Core Courtyard
- Porch Projecting, Porch Engaged, Stoop, Forecourt, Shopfront, and Terrace Frontage Types

T5 Core Main Street 03.100



Zone Abbreviation

T5CMS

Sub-Zone(s)

None

Intent

A walkable, vibrant district of large footprint, high-intensity mixed-use buildings and housing choices supporting ground floor retail, food and services.

Desired Form

- Block-Scale Buildings
- Attached Buildings
- Large Building Footprint
- No Front Setbacks
- No Side Setbacks
- Up to 5 Stories
- Core Courtyard and Main Street Building
- Shopfront, Terrace, and Gallery Frontage Types; Stoop and Maker Shopfront Frontage Types on Side Street

This page intentionally left blank

03.030 T3 Edge Neighborhood (T3EN)



General note: the illustrations above are intended to provide a brief overview of the zone and are descriptive in nature.

1. Intent

A walkable neighborhood environment of small-to-medium footprint, low-intensity housing choices, supporting and within short walking distance of neighborhood-serving retail and services.

The following are generally appropriate form elements in the zone.

House-Scale Buildings	Up to 2.5 Stories
Detached Buildings	
Small-to-Medium Building Footprint	House, Duplex Side-by-Side, Fourplex, Pocket Neighborhood, and Terraced Courtyard Building
Medium-to-Large Front Setbacks	
Medium-to-Large Side Setbacks	Porch Projecting, Porch Engaged, and Dooryard Frontage Types

2. Sub-Zone(s)

None

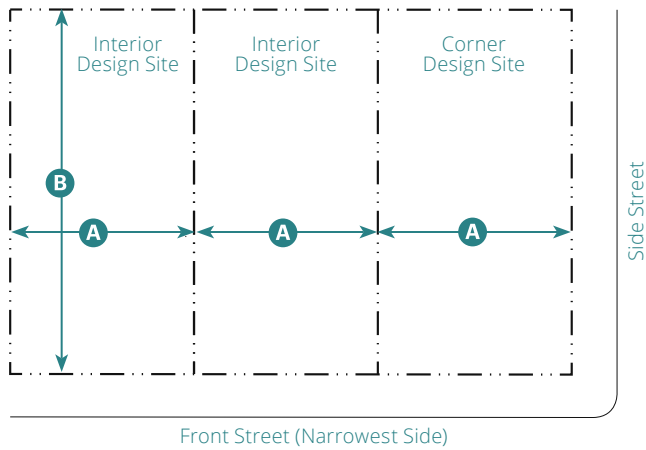

Key

--- ROW/ Design Site Line

3. Building Types and Design Site Size			
Allowed Building Types	Design Site ¹		Standards
	Width A	Depth B	
House-Scale			
Carriage House ²	N/A	N/A	05.040
House	50' min.	100' min.	05.050
Duplex Side-by-Side	55' min.	110' min.	05.060
Fourplex	70' min.	110' min.	05.090
Pocket Neighborhood			05.120
<25% slope	170' min.;	260' min.;	
	300' max.	500' max.	
>25% slope	150' min.;	250' min.;	
	300' max.	500' max.	
Block-Scale			
Terraced Courtyard Building			05.150
<25% slope	Not Allowed		
>25% slope	150' min.;	200' min.;	
	200' max.	300' max.	

Each design site shall have only one primary building type.

¹ Design sites of at least 3 acres or over 700' long or deep are required to include civic space and new street(s) per Chapter 8 (Specific to Large Sites).

² The Carriage House is not a primary building type.

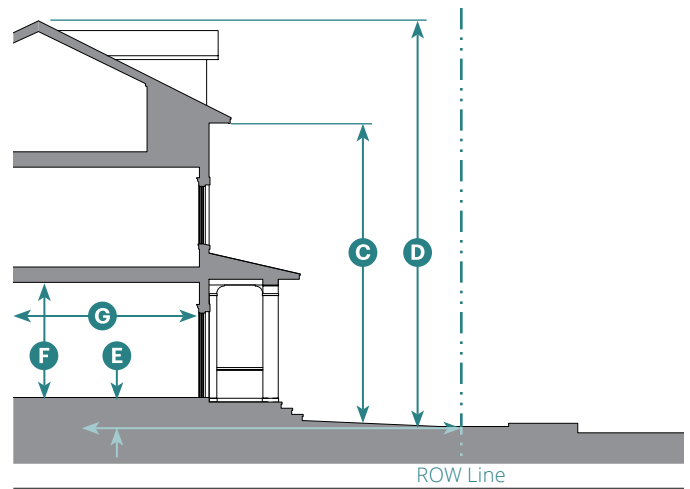

Key

--- ROW Line

4. Building Form		
Height		
Primary Building³		
Stories	2.5 max.	
To Highest Eave/Parapet	22' max.	C
Overall	35' max.	D
Ground Floor Finish Level ⁴		E
Residential	6" min.	
Non-Residential	Not Allowed	
Ground Floor Ceiling		F
Residential	9' min.	
Non-Residential	Not Allowed	
Accessory Structure(s)	1 max.	
Footprint		
Max. Design Site Coverage	See standards in Chapter 5 (Specific to Building Types)	
Depth, Ground-Floor Space	30' min. ⁵	G

³ See Chapter 5 (Specific to Building Types) for refinements to massing and height standards.

⁴ Common entries may be set at grade in compliance with local and federal accessibility standards.

⁵ For habitable/occupiable space only

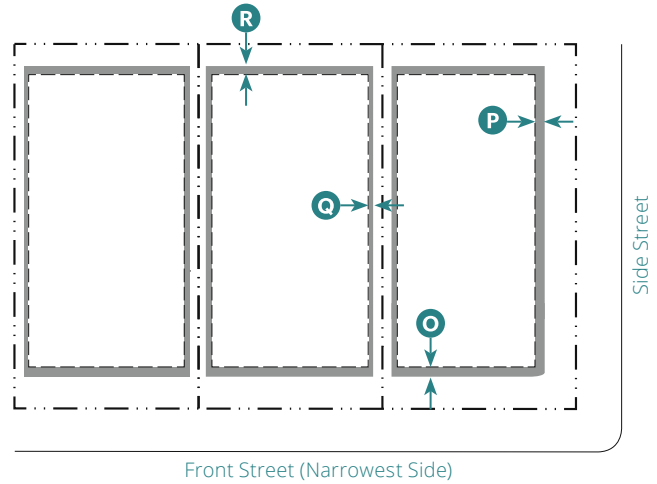
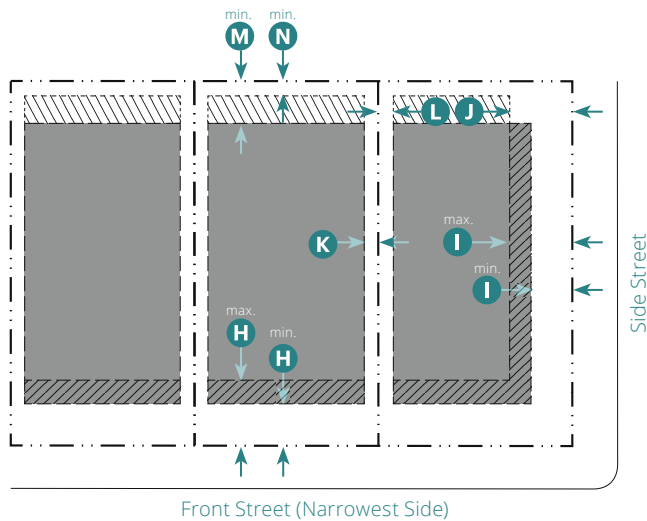

Key	Buildable Area
- - - - -	ROW/ Design Site Line
- - - - -	Building Setback Line
	Acc. Structures Only
	Facade Zone

Key	Encroachment Area
- - - - -	ROW/ Design Site Line
- - - - -	Setback Line

5. Building Placement

Setback (Distance from ROW/ Design Site Line)⁶

Front (Facade Zone)		H
Interior Design Site	20' min.; 30' max.	
Corner Design Site	20' min.; 30' max.	
Side Street (Facade Zone)		
Primary Building	15' min.; 25' max.	I
Accessory Structure(s)	25' min.	J
Side		
Primary Building	10' min.	K
Terraced Courtyard Building	15' min.	
Accessory Structure(s)	5' min.	L
Rear		
Primary Building	20' min.	M
Accessory Structure(s)	5' min.	N

Building Facade

Facade Zone Defined By Main Building/Frontage Type	Front St.	Side St.
--	-----------	----------

Total length of facade required within or abutting facade zone	60% min.	50% min.
--	----------	----------

Facade Design

All building facades shall be designed in compliance with Chapter 7 (Specific to Architectural Design).

⁶ Design sites with slopes ≥ 6% shall comply with Section 04.050 (Slope Standards).

6. Encroachments

Encroachments into Minimum Setbacks

Encroachment Type	Front O	Side St. P	Side Q	Rear R
Private Frontages	15' max.	15' max.	X	X
Architectural Features	5' max.	3' max.	6' max.	8' max.
Patio Covers	X	X	6' max.	8' max.
Stairs/Ramps ⁷	5' max.	3' max.	6' max.	8' max.
Decks (24" Tall Max.)	X	5' max.	5' max.	20' max.

Decks more than 24" above existing grade may not encroach
Ramps providing ADA or FHA visitability are allowed within setbacks but shall not encroach within public ROWs.
No encroachment allowed for Accessory Structures.
Fences, hedges, and other screen devices are allowed within setbacks as identified in Section 04.020 (Screening).

⁷ Stairs that are part of a private frontage may encroach into the setback an additional 3' beyond the allowed encroachment of the private frontage but not into the public ROW.

Encroachments into Public Right of Ways (ROW)

Encroachments not allowed into a street ROW, alley ROW, or across a design site line.

Key	X = Not Allowed	N/A = Not Applicable
------------	-----------------	----------------------

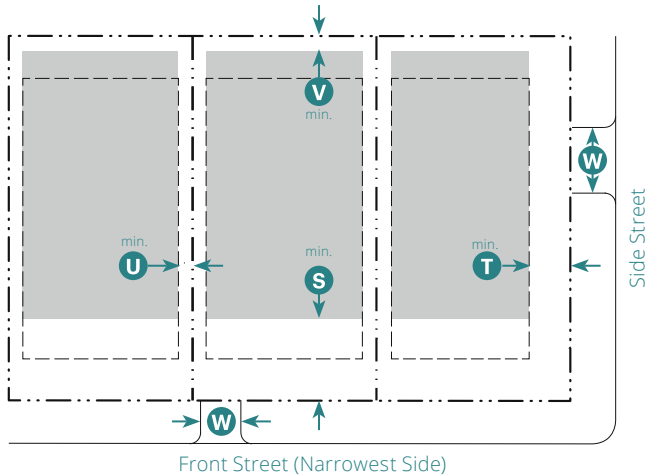

Key

- - - - ROW/ Design Site Line
- - - - Building Setback Line
- Parking Area

7. Parking

Use Type	Vehicular Spaces ⁸	Bicycle Spaces
----------	-------------------------------	----------------

Residential Uses

Studio or 1 Bedroom	1 min. per unit	1 min. per unit
2 or More Bedrooms	1.5 min. per unit	2 min. per unit

Non-Residential Uses per Building⁹

≤ 1,000 sf	0 min.
≥ 1,000 sf	1 min. per 1,000 sf above first 1,000 sf

Setback (Distance from ROW/ Design Site Line)

Front	50' min. ¹⁰	S
Side Street	25' min.	T
Side	5' min.	U
Rear	5' min.	V

Driveway¹¹

Curb Cut/Width		W
1 Unit	12'	
2-6 Units	16'	
>6 Units	28'	
Non-Residential	18'	

Curb cut along alley shall not exceed allowed curb cut width.
 Driveways may be shared between adjacent design sites but shall not exceed minimum allowed width.
 Front access not allowed on corner design sites.
 Bicycles may be parked anywhere on design site, in compliance with pedestrian and vehicular access standards.

7. Parking (Continued)

Parking spaces may be grouped with those on adjacent design sites and may be detached from design sites within the same block, in compliance with parking setbacks and access standards.

Where subterranean parking is provided, the minimum design site depth is allowed to be reduced to only the amount needed for the required rear building setback.

⁸ See Subsection 04.040.5 for additional standards.

⁹ See Title 22, Article II (Zoning Districts and Allowable Uses) for the underlying zone's allowed uses and permit requirements.

¹⁰ 10' min. allowed for parking courts of 6 or fewer spaces. See Figure 04.040.1 (Parking Court(s)).

¹¹ See Subsection 22.04.040.8.B for additional standards.

8. Frontages

Allowed Private Frontage Type	Standards
Porch Projecting	06.040
Porch Engaged	06.050
Dooryard	06.060

Allowed Public Frontage Type	Standards
Street	04.060.C.1

9. Signage

Allowed Sign Type
 See Chapter 22.28 (Signs) for allowed signs and standards.



General note: the illustrations above are intended to provide a brief overview of the zone and are descriptive in nature.

1. Intent

A walkable neighborhood environment of small-to-medium footprint, low-to-moderate-intensity housing choices, supporting and within short walking distance of neighborhood-serving retail and services.

The following are generally appropriate form elements in the zone.

House-Scale Buildings	Up to 2.5 Stories
Primarily Detached Buildings	
Small-to-Medium Building Footprint	House, Duplex Side-by-Side, Cottage Court, Fourplex, Neighborhood
Small-to-Medium Front Setbacks	Townhouse, Pocket Neighborhood, and Terraced Courtyard Building
Small-to-Medium Side Setbacks	Porch Projecting, Porch Engaged, and Dooryard Frontage Types

2. Sub-Zone(s)

None

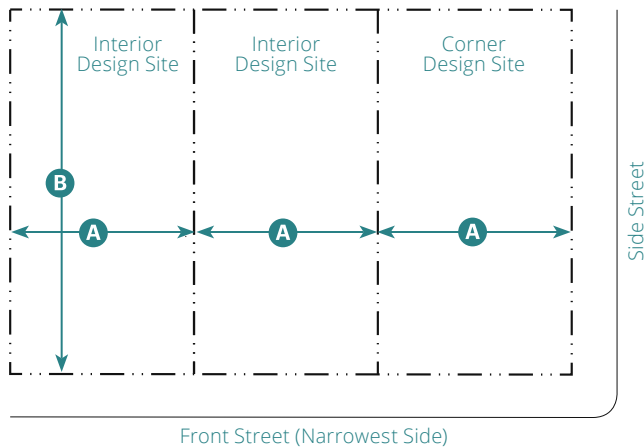

Key

--- ROW/ Design Site Line

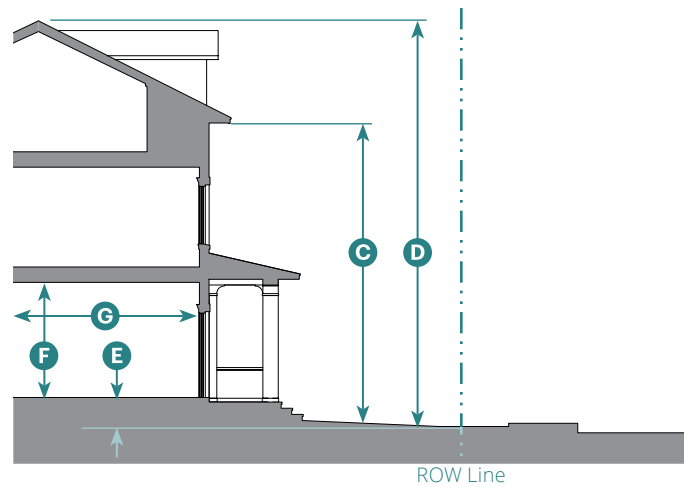

Key

--- ROW Line

3. Building Types and Design Site Size			
Allowed Building Types	Design Site ¹		Standards
	Width A	Depth B	
House-Scale			
Carriage House ²	N/A	N/A	05.040
House	50' min.	100' min.	05.050
Duplex Side-by-Side	50' min.	110' min.	05.060
Cottage Court	125' min.	130' min.	05.080
Fourplex	50' min.	110' min.	05.090
Neighborhood Townhouse	24' min. ³	100' min.	05.100
Pocket Neighborhood			05.120
<25% slope	170' min.;	260' min.;	
	300' max.	500' max.	
>25% slope	150' min.;	250' min.;	
	300' max.	500' max.	
Block-Scale			
Terraced Courtyard Building			05.150
<25% slope	Not Allowed		
>25% slope	150' min.;	200' min.;	
	200' max.	300' max.	

Each design site shall have only one primary building type.

¹ Design sites of at least 3 acres or over 700' long or deep are required to include civic space and new street(s) per Chapter 8 (Specific to Large Sites).

² The Carriage House is not a primary building type.

³ Represents one townhouse

4. Building Form		
Height		
Primary Building⁴		
Stories	2.5 max.	
To Highest Eave/Parapet	22' max.	C
Overall	35' max.	D
Ground Floor Finish Level ⁵		E
Residential	6" min.	
Non-Residential	Not Allowed	
Ground Floor Ceiling		F
Residential	9' min.	
Non-Residential	Not Allowed	
Accessory Structure(s) 1 max.		
Footprint		
Max. Design Site Coverage	See standards in Chapter 5 (Specific to Building Types)	
Depth, Ground-Floor Space ⁶		G
Cottage Court	15' min.	
All Building Types	30' min.	

⁴ See Chapter 5 (Specific to Building Types) for refinements to massing and height standards.

⁵ Common entries may be set at grade in compliance with local and federal accessibility standards.

⁶ For habitable/occupiable space only, except in the Cottage Court Building Type

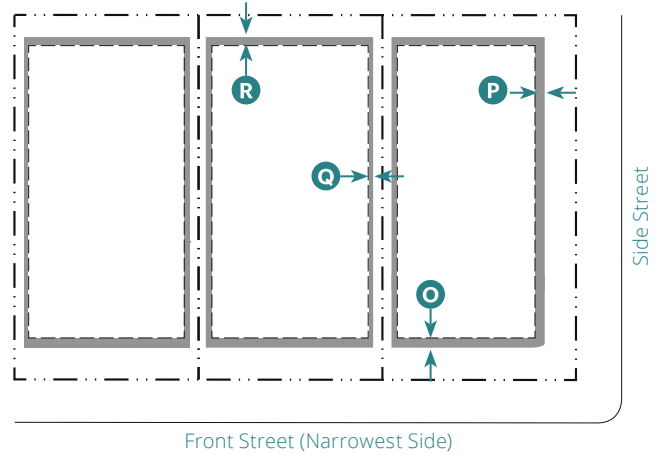
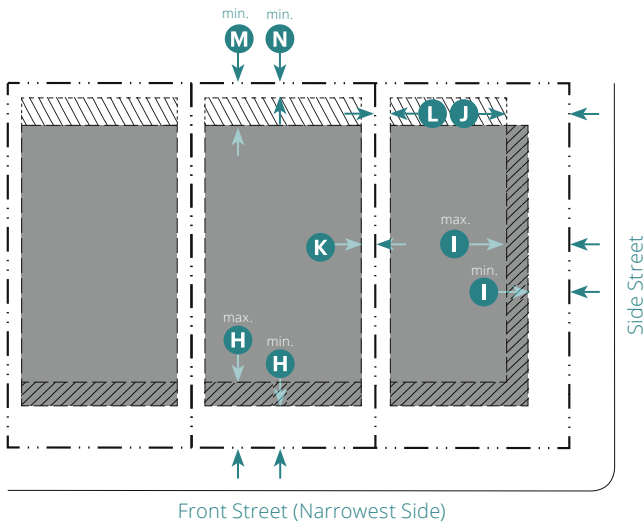

Key	Buildable Area
- - - - ROW/ Design Site Line	Acc. Structures Only
- - - - Building Setback Line	Facade Zone

Key	Encroachment Area
- - - - ROW/ Design Site Line	
- - - - Setback Line	

5. Building Placement

Setback (Distance from ROW/ Design Site Line)⁷

Front (Facade Zone)		H
Interior Design Site	15' min.; 25' max.	
Corner Design Site	15' min.; 25' max.	
Side Street (Facade Zone)		
Primary Building	10' min.; 20' max.	I
Accessory Structure(s)	20' min.	J
Side		
Primary Building	7' min.	K
Terraced Courtyard Building	15' min.	
Accessory Structure(s)	5' min.	L
Rear		
Primary Building	20' min.	M
Accessory Structure(s)	5' min.	N

Building Facade

Facade Zone Defined By Main Building/Frontage Type	Front St.	Side St.
--	-----------	----------

Total length of facade required within or abutting facade zone	60% min.	50% min.
--	----------	----------

Facade Design

All building facades shall be designed in compliance with Chapter 7 (Specific to Architectural Design).

⁷Design sites with slopes ≥ 6% shall comply with Section 04.050 (Slope Standards).

6. Encroachments

Encroachments into Minimum Setbacks

Encroachment Type	Front O	Side St. P	Side Q	Rear R
Private Frontages	10' max.	10' max	X	X
Architectural Features	4' max.	4' max.	3' max.	8' max.
Patio Covers	X	X	3' max.	8' max.
Stairs/Ramps ⁸	4' max.	4' max.	3' max.	8' max.
Decks (24" Tall Max.)	X	5' max.	5' max.	20' max.

Decks more than 24" above existing grade may not encroach

Ramps providing ADA or FHA visitability are allowed within setbacks but shall not encroach within public ROWs.

No encroachment allowed for Accessory Structures.

Fences, hedges, and other screen devices are allowed within setbacks as identified in Section 04.020 (Screening).

⁸Stairs that are part of a private frontage may encroach into the setback an additional 3' beyond the allowed encroachment of the private frontage but not into the public ROW.

Encroachments into Public Right of Ways (ROW)

Encroachments not allowed into a street ROW, alley ROW, or across a design site line.

Key	X = Not Allowed	N/A = Not Applicable
------------	-----------------	----------------------

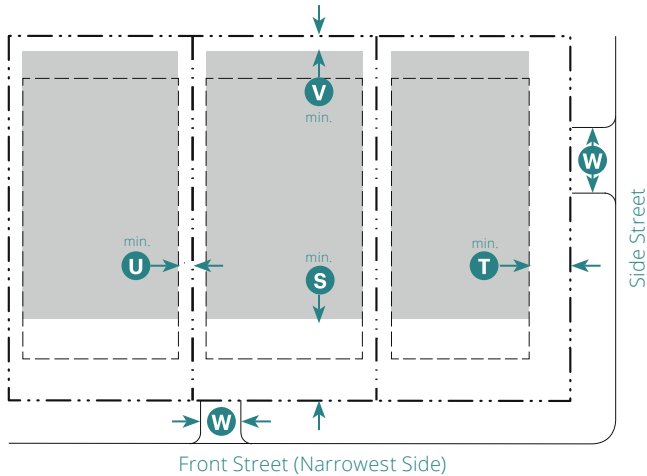

Key

- - - - ROW/ Design Site Line
- - - - Building Setback Line
- Parking Area

7. Parking

Use Type	Vehicular Spaces ⁹	Bicycle Spaces
Residential Uses		
Studio or 1 Bedroom	1 min. per unit	1 min. per unit
2 or More Bedrooms	1.5 min. per unit	2 min. per unit
Non-Residential Uses per Building¹⁰		
≤ 1,000 sf	0 min.	
≥ 1,000 sf	1 min. per 1,000 sf above first 1,000 sf	

Setback (Distance from ROW/ Design Site Line)

Front	50' min. ¹¹	S
Side Street	20' min.	T
Side	5' min.	U
Rear	5' min.	V

Driveway¹²

Curb Cut/Width		W
1 Unit	12'	
2-6 Units	16'	
>6 Units	28'	
Non-Residential	18'	

Curb cut along alley shall not exceed allowed curb cut width.
 Driveways may be shared between adjacent design sites but shall not exceed minimum allowed width.
 Front access not allowed on corner design sites.
 Bicycles may be parked anywhere on design site, in compliance with pedestrian and vehicular access standards.

7. Parking (Continued)

Parking spaces may be grouped with those on adjacent design sites and may be detached from design sites within the same block, in compliance with parking setbacks and access standards.

Where subterranean parking is provided, the minimum design site depth is allowed to be reduced to only the amount needed for the required rear building setback.

⁹ See Subsection 04.040.5 for additional standards.

¹⁰ See Title 22, Article II (Zoning Districts and Allowable Uses) for the underlying zone's allowed uses and permit requirements.

¹¹ 10' min. allowed for parking courts of 6 or fewer spaces. See Figure 04.040.1 (Parking Court(s)).

¹² See Subsection 22.04.040.8.B for additional standards.

8. Frontages

Allowed Private Frontage Type	Standards
Porch Projecting	06.040
Porch Engaged	06.050
Dooryard	06.060

Allowed Public Frontage Type	Standards
Street	04.060.C.1

9. Signage

Allowed Sign Type
 See Chapter 22.28 (Signs) for allowed signs and standards.



General note: the illustrations above are intended to provide a brief overview of the zone and are descriptive in nature.

1. Intent

A walkable neighborhood environment of small-to-medium footprint, moderate-intensity housing choices, supporting and within short walking distance of neighborhood-serving retail and services.

The following are generally appropriate form elements in the zone.

House-Scale Buildings	House, Duplex Stacked, Cottage
Primarily Detached Buildings	Court, Fourplex, Neighborhood
Small-to-Medium Building Footprint	Townhouse, Neighborhood Courtyard,
Small-to-Medium Front Setbacks	Pocket Neighborhood, Multiplex, and
	Terraced Courtyard Building
Small-to-Medium Side Setbacks	Porch Projecting, Porch Engaged,
Up to 2.5 Stories	Dooryard, and Stoop Frontage Types

2. Sub-Zone(s)

None

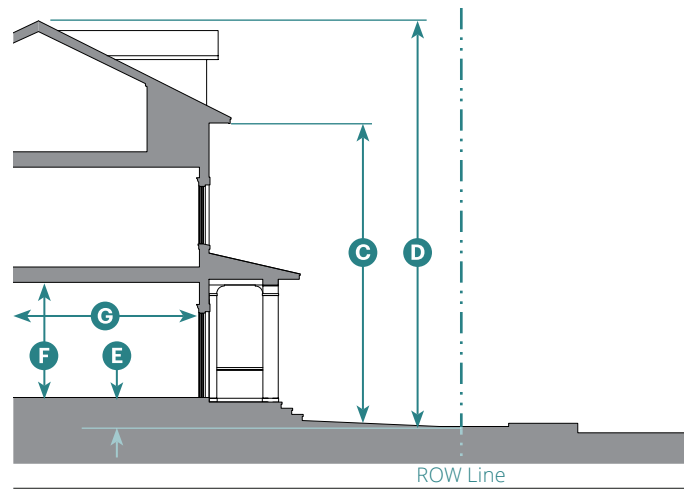
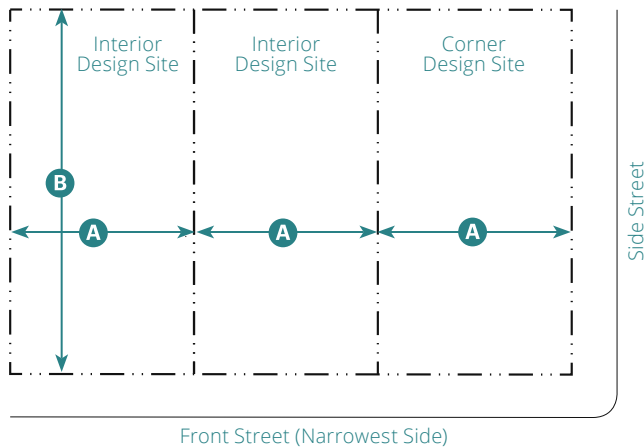

Key

--- ROW/ Design Site Line

3. Building Types and Design Site Size

Allowed Building Types	Width A	Depth B	Standards
------------------------	----------------	----------------	-----------

House-Scale			
Carriage House ²	N/A	N/A	05.040
House	50' min.	100' min.	05.050
Duplex Stacked	50' min.	100' min.	05.070
Cottage Court	90' min.	120' min.	05.080
Fourplex	50' min.	110' min.	05.090
Nbrhd Townhse	18' min. ³	100' min.	05.100
Neighborhood Courtyard			
L-shaped	80' min.	150' min.	
U-shaped	100' min.	150' min.	
Pocket Neighborhood			
<25% slope	170' min.;	260' min.;	05.120
	300' max.	500' max.	
>25% slope	150' min.;	250' min.;	
	300' max.	500' max.	
Multiplex	75' min.	125' min.	05.130

Block-Scale			
Terraced Courtyard Building			05.150
<25% slope	Not Allowed		
>25% slope	150' min.;	200' min.;	
	200' max.	300' max.	

Each design site shall have only one primary building type.

¹ Design sites of at least 3 acres or over 700' long or deep are required to include civic space and new street(s) per Chapter 8 (Specific to Large Sites).

Key

--- ROW Line

3. Building Types and Design Site Size (Continued)

² The Carriage House is not a primary building type.

³ Represents one townhouse

4. Building Form

Height

Primary Building ⁴		
Stories	2.5 max.	
To Highest Eave/Parapet	24' max.	C
Overall	35' max.	D
Ground Floor Finish Level ⁵		
Residential	6' min.	E
Non-Residential	6' max.	
Ground Floor Ceiling		
Residential	9' min.	F
Non-Residential	12' min.	

Accessory Structure(s) 1 max.

Footprint

Max. Design Site Coverage	See standards in Chapter 5 (Specific to Building Types)
Depth, Ground-Floor Space ⁶	
Cottage Court	15' min.
All Building Types	20' min.

⁴ See Chapter 5 (Specific to Building Types) for refinements to massing and height standards.

⁵ Common entries may be set at grade in compliance with local and federal accessibility standards.

⁶ For habitable/occupiable space only, except in the Cottage Court Building Type

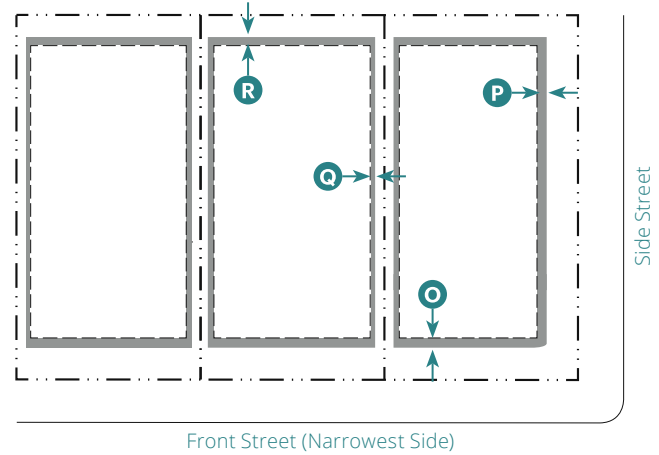
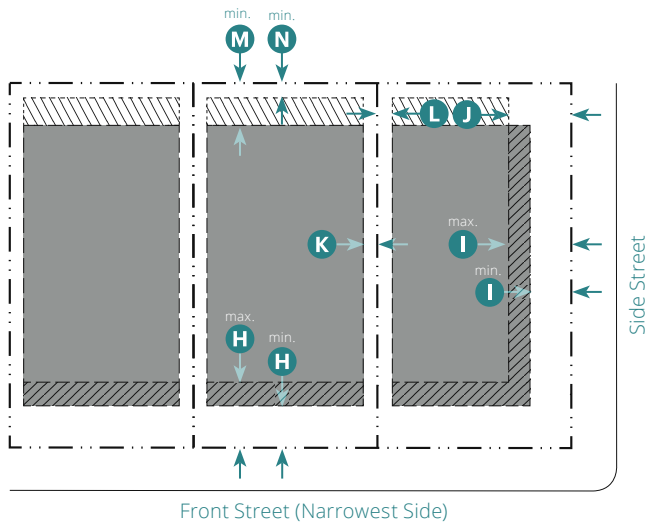

Key	Buildable Area
- - - - ROW/ Design Site Line	Acc. Structures Only
- - - - Building Setback Line	Facade Zone

Key	Encroachment Area
- - - - ROW/ Design Site Line	
- - - - Setback Line	

5. Building Placement

Setback (Distance from ROW/ Design Site Line)⁷

Front (Facade Zone)		H
Interior Design Site	10' min.; 20' max.	
Corner Design Site	10' min.; 20' max.	
Side Street (Facade Zone)		
Primary Building	10' min.; 20' max.	I
Accessory Structure(s)	20' min.	J
Side		
Primary Building	7' min.	K
Terraced Courtyard Building	15' min.	
Accessory Structure(s)	5' min.	L
Rear		
Primary Building	15' min.	M
Accessory Structure(s)	5' min.	N

Building Facade

Facade Zone Defined By Main Building/Frontage Type	Front St.	Side St.
Total length of facade required within or abutting facade zone	65% min.	55% min.

Facade Design

All building facades shall be designed in compliance with Chapter 7 (Specific to Architectural Design).

⁷ Design sites with slopes ≥ 6% shall comply with Section 04.050 (Slope Standards).

6. Encroachments

Encroachments into Minimum Setbacks

Encroachment Type	Front O	Side St. P	Side Q	Rear R
Private Frontages	10' max.	10' max.	X	X
Architectural Features	3' max.	3' max.	3' max.	5' max.
Patio Covers	X	X	3' max.	5' max.
Stairs/Ramps	3' max.	3' max.	3' max.	5' max.
Decks (24" Tall Max.)	X	5' max.	5' max.	20' max.

Decks more than 24" above existing grade may not encroach

Ramps providing ADA or FHA visitability are allowed within setbacks but shall not encroach within public ROWs.

No encroachment allowed for Accessory Structures.

Fences, hedges, and other screen devices are allowed within setbacks as identified in Section 04.020 (Screening).

Encroachments into Public Right of Ways (ROW)

Encroachments not allowed into a street ROW, alley ROW, or across a design site line.

Key	X = Not Allowed	N/A = Not Applicable
------------	-----------------	----------------------

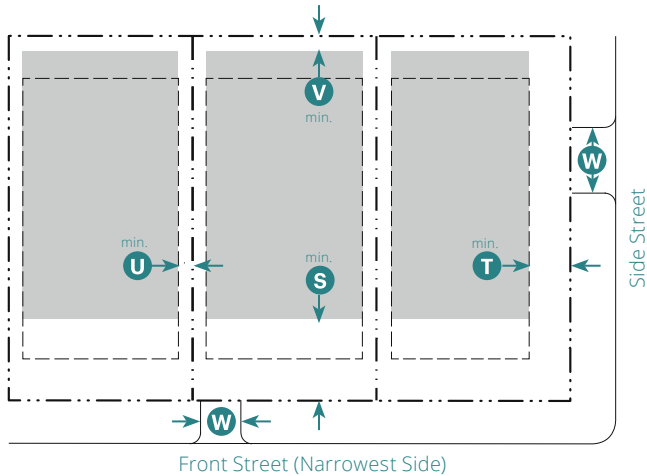

Key

- - - - ROW/ Design Site Line
- - - - Building Setback Line
- Parking Area

7. Parking

Use Type	Vehicular Spaces ⁸	Bicycle Spaces
----------	-------------------------------	----------------

Residential Uses

Studio or 1 Bedroom	1 min. per unit	1 min. per unit
2 or More Bedrooms	1.5 min. per unit	2 min. per unit

Non-Residential Uses per Building⁹

≤ 1,000 sf	0 min.
≥ 1,000 sf	1 min. per 1,000 sf above first 1,000 sf

Setback (Distance from ROW/ Design Site Line)

Front	40' min. ¹⁰	S
Side Street	20' min.	T
Side	5' min.	U
Rear	5' min.	V

Driveway¹¹

Curb Cut/Width	Width	Symbol
1 Unit	12'	W
2-6 Units	16'	
>6 Units	28'	
Non-Residential	18'	

Curb cut along alley shall not exceed allowed curb cut width.
 Driveways may be shared between adjacent design sites but shall not exceed minimum allowed width.
 Front access not allowed on corner design sites.
 Bicycles may be parked anywhere on design site, in compliance with pedestrian and vehicular access standards.

7. Parking (Continued)

Parking spaces may be grouped with those on adjacent design sites and may be detached from design sites within the same block, in compliance with parking setbacks and access standards.

Where subterranean parking is provided, the minimum design site depth is allowed to be reduced to only the amount needed for the required rear building setback.

⁸ See Subsection 04.040.5 for additional standards.

⁹ See Title 22, Article II (Zoning Districts and Allowable Uses) for the underlying zone's allowed uses and permit requirements.

¹⁰ 10' min. allowed for parking courts of 6 or fewer spaces. See Figure 04.040.1 (Parking Court(s)).

¹¹ See Subsection 22.04.040.8.B for additional standards.

8. Frontages

Allowed Private Frontage Type	Standards
Porch Projecting	06.040
Porch Engaged	06.050
Dooryard	06.060
Stoop	06.070
Shopfront ¹²	06.100

Allowed Public Frontage Type

Allowed Public Frontage Type	Standards
Street	04.060.C.1

¹² Only on side street

9. Signage

Allowed Sign Type

See Chapter 22.28 (Signs) for allowed signs and standards.



General note: the illustrations above are intended to provide a brief overview of the zone and are descriptive in nature.

1. Intent

A walkable neighborhood environment with medium-to-large footprint, moderate-intensity housing choices, supporting and within short walking distance of neighborhood-serving retail and services.

The following are generally appropriate form elements in the zone.

Primarily House-Scale Buildings	House, Neighborhood Courtyard,
Primarily Detached Buildings	Multiplex, and Terraced Courtyard
Medium-to-Large Building Footprint	Building
Small Front Setbacks	Porch Projecting, Porch Engaged,
Small Side Setbacks	Dooryard, Stoop, Shopfront, and
Up to 3.5 Stories	Terrace Frontage Types

2. Sub-Zone(s)

None

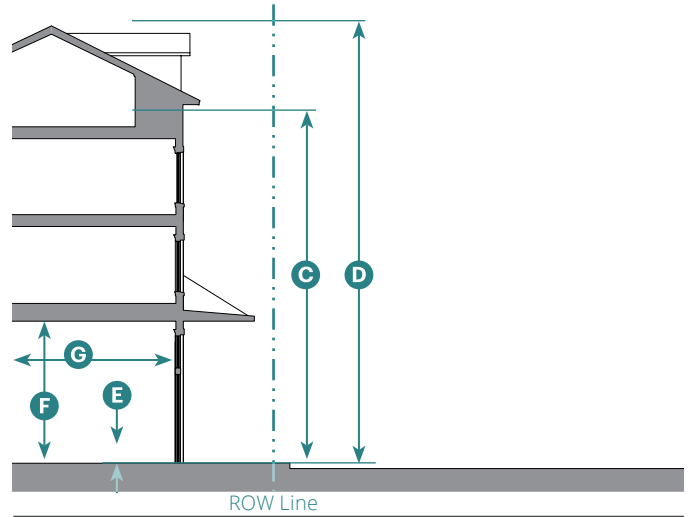
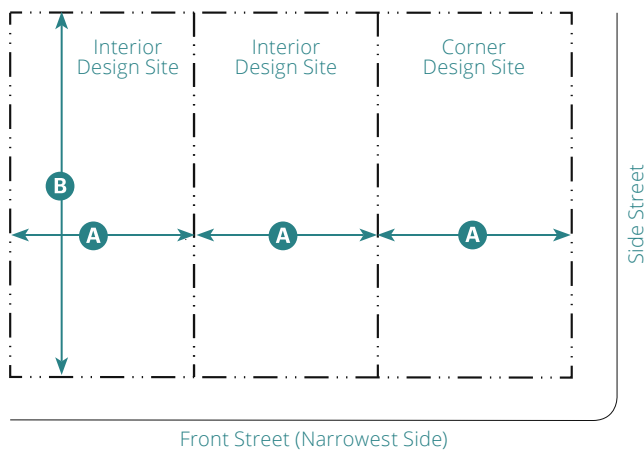

Key

--- ROW/ Design Site Line

Key

--- ROW Line

3. Building Types and Design Site Size			
Allowed Building Types	Design Site ¹		Standards
	Width A	Depth B	
House-Scale			
Carriage House ²	N/A	N/A	05.040
House	50' min.	100' min.	05.050
Neighborhood Courtyard			05.110
L-shaped	80' min.	150' min.	
U-shaped	100' min.	150' min.	
Multiplex	75' min.	110' min.	05.130
Block-Scale			
Terraced Courtyard Building			05.150
<25% slope	Not Allowed		
>25% slope	150' min.;	200' min.;	
	200' max.	300' max.	

Each design site shall have only one primary building type.

¹ Design sites of at least 3 acres or over 700' long or deep are required to include civic space and new street(s) per Chapter 8 (Specific to Large Sites).

² The Carriage House is not a primary building type.

4. Building Form		
Height		
Primary Building³		
Stories	3.5 max.	
To Highest Eave/Parapet	34' max.	C
Overall	45' max.	D
Ground Floor Finish Level ⁴		E
Residential	6" min.	
Non-Residential	6" max.	
Ground Floor Ceiling		F
Residential	9' min.	
Non-Residential	12' min.	
Accessory Structure(s)	1 max.	
Footprint		
Max. Design Site Coverage	See standards in Chapter 5 (Specific to Building Types)	
Depth, Ground-Floor Space	20' min. ⁵	G

³ See Chapter 5 (Specific to Building Types) for refinements to massing and height standards.

⁴ Common entries may be set at grade in compliance with local and federal accessibility standards.

⁵ For habitable/occupiable space only

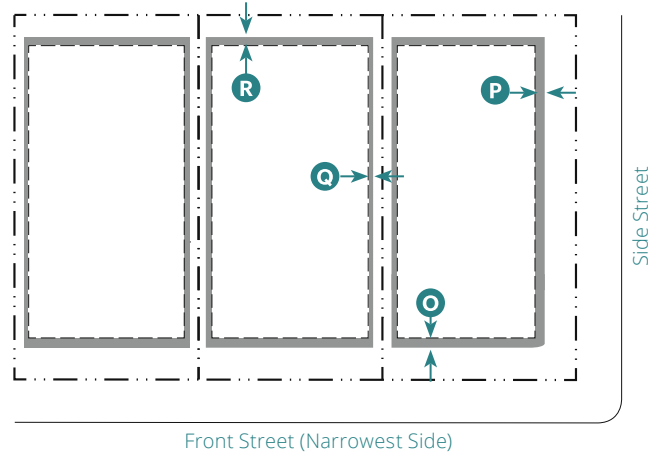
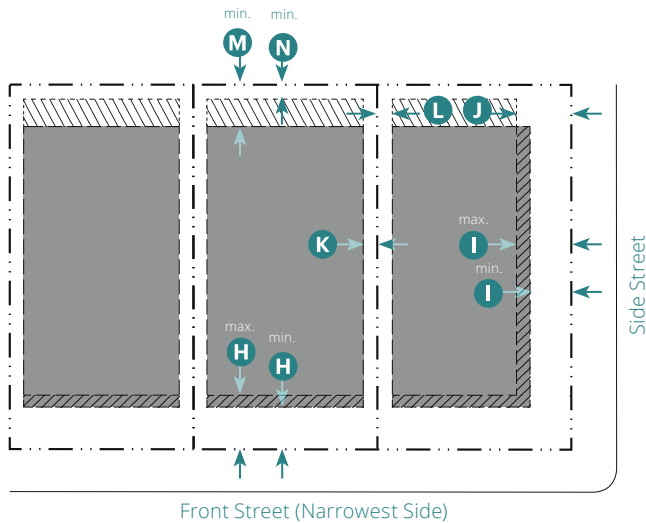

Key	Buildable Area
- · - · - ROW/ Design Site Line	Acc. Structures Only
- - - Building Setback Line	Facade Zone

5. Building Placement

Setback (Distance from ROW/ Design Site Line)⁶

Front (Facade Zone)		H
Interior Design Site	8' min.; 15' max.	
Corner Design Site	8' min.; 15' max.	
Side Street (Facade Zone)		
Primary Building	8' min.; 15' max.	I
Accessory Structure(s)	15' min.	J
Side		
Primary Building	5' min.	K
Terraced Courtyard Building	15' min.	
Accessory Structure(s)	5' min.	L
Rear		
Primary Building	15' min.	M
Accessory Structure(s)	5' min.	N

Building Facade

Facade Zone Defined By Main Building/Frontage Type	Front St.	Side St.
Total length of facade required within or abutting facade zone	70% min.	60% min.

Facade Design

All building facades shall be designed in compliance with Chapter 7 (Specific to Architectural Design).

⁶Design sites with slopes ≥ 6% shall comply with Section 04.050 (Slope Standards).

Key	Encroachment Area
- · - · - ROW/ Design Site Line	
- - - Setback Line	

6. Encroachments

Encroachments into Minimum Setbacks

Encroachment Type	Front O	Side St. P	Side Q	Rear R
Private Frontages	8' max.	8' max.	X	X
Architectural Features	2' max.	2' max.	1' max.	5' max.
Patio Covers	X	X	1' max.	5' max.
Stairs/Ramps	2' max.	2' max.	1' max.	5' max.
Decks (24" Tall Max.)	X	5' max.	5' max.	20' max.

Decks more than 24" above existing grade may not encroach
Ramps providing ADA or FHA visitability are allowed within setbacks but shall not encroach within public ROWs.
No encroachment allowed for Accessory Structures.

Encroachments into Public Right of Ways (ROW)

Encroachments not allowed into a street ROW, alley ROW, or across a design site line.

Key	X = Not Allowed	N/A = Not Applicable
------------	-----------------	----------------------

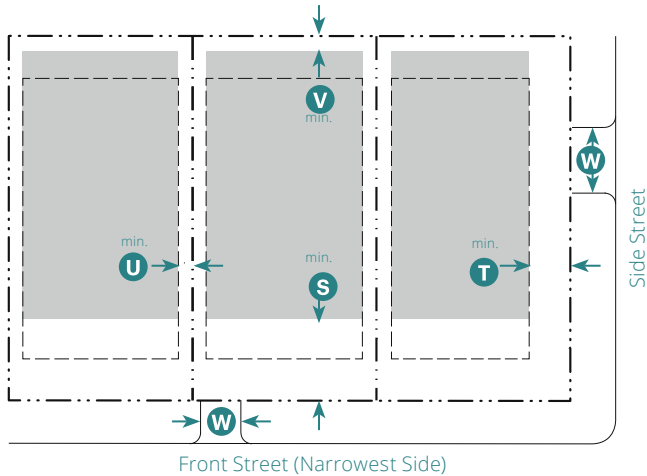

Key

- · - · - · ROW/ Design Site Line
- - - - - Building Setback Line
- Parking Area

7. Parking		
Use Type	Vehicular Spaces ⁷	Bicycle Spaces
Residential Uses		
Studio or 1 Bedroom	1 min. per unit	1 min. per unit
2 or More Bedrooms	1.25 min. per unit	2 min. per unit
Non-Residential Uses per Building⁸		
≤ 1,000 sf	0 min.	
≥ 1,000 sf	1 min. per 1,000 sf above first 1,000 sf	
Setback (Distance from ROW/ Design Site Line)		
Front	40' min. ⁹	S
Side Street	15' min.	T
Side	5' min.	U
Rear	5' min.	V
Driveway¹⁰		
Curb Cut/Width W		
1 Unit	12'	
2-6 Units	16'	
>6 Units	28'	
Non-Residential	18'	

Curb cut along alley shall not exceed allowed curb cut width.
 Driveways may be shared between adjacent design sites but shall not exceed allowed curb cut width.
 Front access not allowed on corner design sites.
 Bicycles may be parked anywhere on design site, in compliance with pedestrian and vehicular access standards.

7. Parking (Continued)

Parking spaces may be grouped with those on adjacent design sites and may be detached from design sites within the same block, in compliance with parking setbacks and access standards.

Where subterranean parking is provided, the minimum design site depth is allowed to be reduced to only the amount needed for the required rear building setback.

⁷ See Subsection 04.040.5 for additional standards.

⁸ See Title 22, Article II (Zoning Districts and Allowable Uses) for the underlying zone's allowed uses and permit requirements.

⁹ 10' min. allowed for parking courts of 6 or fewer spaces. See Figure 04.040.1 (Parking Court(s)).

¹⁰ See Subsection 22.04.040.8.B for additional standards.

8. Frontages

Allowed Private Frontage Type	Standards
Porch Projecting	06.040
Porch Engaged	06.050
Dooryard	06.060
Stoop	06.070
Shopfront ¹¹	06.100
Terrace ¹¹	06.110
Allowed Public Frontage Type	Standards
Street	04.060.C.1

¹¹ Only on side street

9. Signage

Allowed Sign Type

See Chapter 22.28 (Signs) for allowed signs and standards.

03.070 T4 Suburban Main Street.Small (T4SMS.S)



General note: the illustrations above are intended to provide a brief overview of the zone and are descriptive in nature.

1. Intent

A walkable, vibrant district of small-to-medium footprint, moderate intensity, mixed-use buildings and housing choices, supporting neighborhood-serving ground floor retail, food and services.

The following are generally appropriate form elements in the zone.

Primarily House-Scale Buildings	House, Neighborhood Townhouse,
Primarily Attached Buildings	Neighborhood Courtyard, Multiplex,
Small-to-Medium Building Footprint	and Main Street Building
None-to-Small Front Setbacks	Porch Projecting, Porch Engaged,
None-to-Small Side Setbacks	Forecourt, Shopfront, Terrace, and
Up to 2.5 Stories	Gallery Frontage Types; Dooryard, Stoop, and Maker Shopfront Frontage Types on Side Street

2. Sub-Zone(s)

None

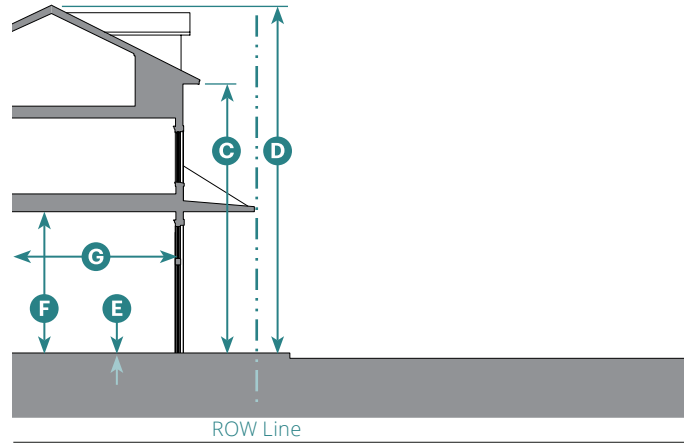
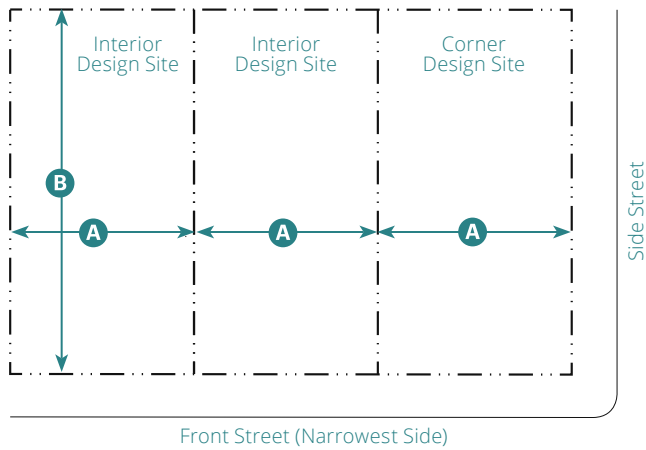

Key

--- ROW/ Design Site Line

Key

--- ROW Line

3. Building Types and Design Site Size

Allowed Building Types	Design Site ¹		Standards
	Width A	Depth B	
House-Scale			
Carriage House ²	N/A	N/A	05.040
House	50' min.	100' min.	05.050
Neighborhood Townhouse	18' min. ³	100' min.	05.100
Neighborhood Courtyard			05.110
L-shaped	80' min.	150' min.	
U-shaped	100' min.	150' min.	
Multiplex	60' min.	110' min.	05.130

Block-Scale

Main Street Building	25' min.	100' min.	05.170
----------------------	----------	-----------	--------

Each design site shall have only one primary building type.

¹Design sites of at least 3 acres or over 700' long or deep are required to include civic space and new street(s) per Chapter 8 (Specific to Large Sites).

²The Carriage House is not a primary building type.

³Represents one townhouse

4. Building Form

Height

Primary Building ⁴		
Stories	2.5 max.	
To Highest Eave/Parapet	24' max.	C
Overall	35' max	D
Ground Floor Finish Level ⁵		E
Residential	6" min. ⁶	
Non-Residential	6" max.	
Ground Floor Ceiling	14' min.	F

Accessory Structure(s) 1 max.

Footprint

Max. Design Site Coverage	See standards in Chapter 5 (Specific to Building Types)	
Depth, Ground-Floor Space	30' min. ⁷	G

⁴See Chapter 5 (Specific to Building Types) for refinements to massing and height standards.

⁵Common entries may be set at grade in compliance with local and federal accessibility standards.

⁶Only on side street and at least 60' from front of design site

⁷For habitable/occupiable space only

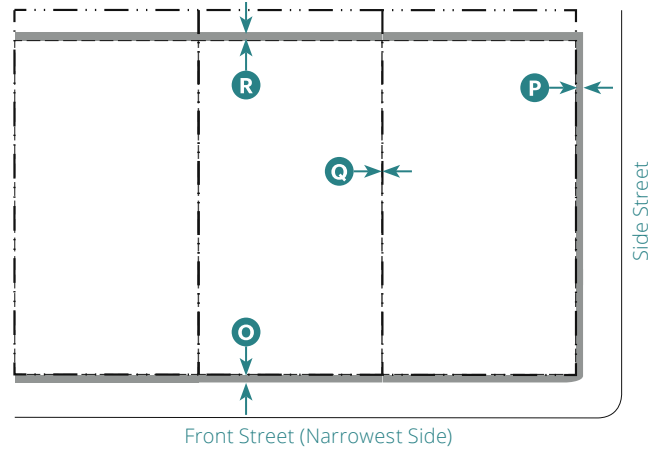
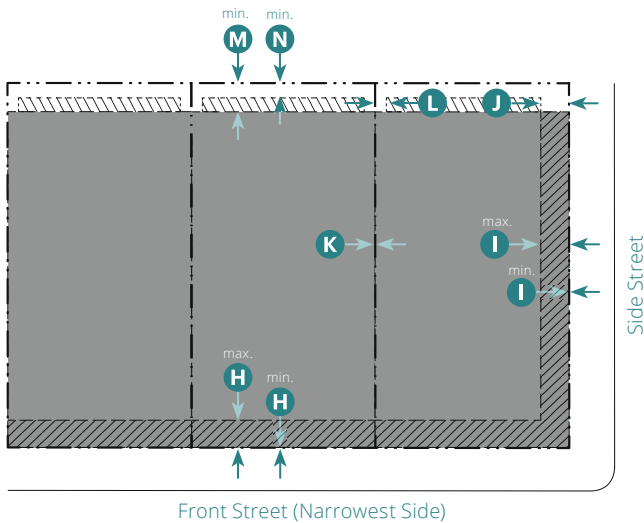

Key	Buildable Area
- - - - ROW/ Design Site Line	Acc. Structures Only
- - - - Building Setback Line	Facade Zone

5. Building Placement

Setback (Distance from ROW/ Design Site Line)⁸

Front (Facade Zone) ⁹		H
Interior Design Site	0' min.; 10' max.	
Corner Design Site	0' min.; 10' max.	
Side Street (Facade Zone)		
Primary Building ⁹	0' min.; 10' max.	I
Accessory Structure(s)	10' min.	J
Side		
Primary Building	0' min.	K
Adjacent to T3EN or Res'I Zone	10' min.	
Accessory Structure(s)	3' min.	L
Rear		
Primary Building	15' min.	M
Adjacent to T3EN or Res'I Zone	20' min.	
Accessory Structure(s)	5' min.	N

Building Facade

Facade Zone Defined By Main Building/Frontage Type	Front St.	Side St.
Total length of facade required within or abutting facade zone	65% min.	55% min.

Facade Design

All building facades shall be designed in compliance with Chapter 7 (Specific to Architectural Design).

Key	Encroachment Area
- - - - ROW/ Design Site Line	
- - - - Setback Line	

5. Building Placement (Continued)

⁸Design sites with slopes \geq 6% shall comply with Section 04.050 (Slope Standards).

⁹Design to Topic 405 (Intersection Design Standards) of the Caltrans Design Standards, if greater than required setback of the zone

6. Encroachments

Encroachments into Minimum Setbacks

Encroachment Type	Front O	Side St. P	Side Q	Rear R
Private Frontages	X	X	X	X
Architectural Features	3' max.	3' max.	X	5' max.
Patio Covers	X	X	X	5' max.
Stairs/Ramps	3' max.	3' max.	X	5' max.

Ramps providing ADA or FHA visitability are allowed within setbacks but shall not encroach within public ROWs.

No encroachment allowed for Accessory Structures.

Fences, hedges, and other screen devices are allowed within setbacks as identified in Section 04.020 (Screening).

Encroachments into Public Right of Ways (ROW)

Encroachments at grade not allowed within a street ROW, alley ROW, or across a design site line.

Upper story encroachments, including the Gallery (06.120), on front and side street require 8' min. of vertical clearance.

Key	X = Not Allowed	N/A = Not Applicable
------------	-----------------	----------------------

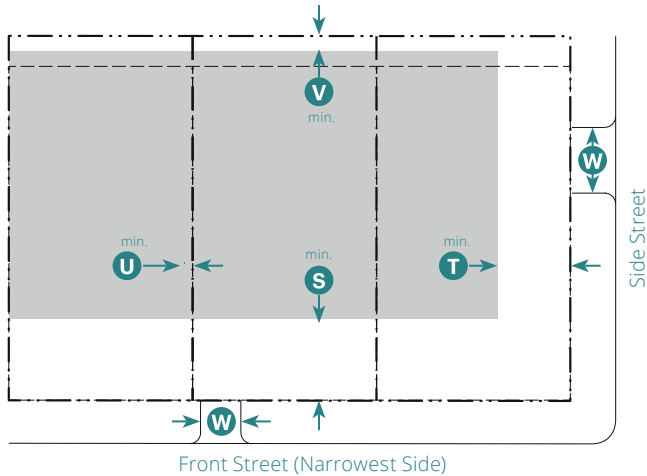

Key

- - - ROW/ Design Site Line
- - - Building Setback Line
- Parking Area

7. Parking		
Use Type	Vehicular Spaces ¹⁰	Bicycle Spaces
Residential Uses		
Studio or 1 Bedroom	1 min. per unit	1 min. per unit
2 or More Bedrooms	1 min. per unit	2 min. per unit
Non-Residential Uses per Building¹¹		
≤ 3,000 sf	0 min.	
≥ 3,000 sf	1 min. per 1,000 sf above first 3,000 sf	
Setback (Distance from ROW/ Design Site Line)		
Front	40' min. ¹²	S
Side Street	40' min.	T
Side	0' min.	U
Rear	5' min.	V
Driveway¹³		
Curb Cut/Width W		
1 Unit	12'	
2-6 Units	16'	
>6 Units	28'	
Non-Residential	18'	

Curb cut along alley shall not exceed allowed curb cut width.
 Driveways may be shared between adjacent design sites but shall not exceed minimum allowed width.
 Front access not allowed on corner design sites.
 Bicycles may be parked anywhere on design site, in compliance with pedestrian and vehicular access standards.

7. Parking (Continued)

Parking spaces may be grouped with those on adjacent design sites and may be detached from design sites within the same block, in compliance with parking setbacks and access standards.

Where subterranean parking is provided, the minimum design site depth is allowed to be reduced to only the amount needed for the required rear building setback.

¹⁰ See Subsection 04.040.5 for additional standards.

¹¹ See Title 22, Article II (Zoning Districts and Allowable Uses) for the underlying zone's allowed uses and permit requirements.

¹² 10' min. allowed for parking courts of 6 or fewer spaces. See Figure 04.040.1 (Parking Court(s)).

¹³ See Subsection 22.04.040.8.B for additional standards.

8. Frontages

Allowed Private Frontage Type	Standards
Porch Projecting	06.040
Porch Engaged	06.050
Dooryard ¹⁴	06.060
Stoop ¹⁴	06.070
Forecourt	06.080
Maker Shopfront ¹⁴	06.090
Shopfront	06.100
Terrace	06.110
Gallery	06.120
Allowed Public Frontage Type	Standards
Avenue/Boulevard	04.060.C.2
Main Street	04.060.C.3

¹⁴ Only on side street

9. Signage

Allowed Sign Type

See Chapter 22.28 (Signs) for allowed signs and standards.



General note: the illustrations above are intended to provide a brief overview of the zone and are descriptive in nature.

1. Intent

A walkable, vibrant district of medium-to-large footprint, moderate intensity, mixed-use buildings and housing choices, supporting neighborhood-serving ground floor retail, food and services.

The following are generally appropriate form elements in the zone.

Block-Scale Buildings

Primarily Attached Buildings

Medium-to-Large Building Footprint

None-to-Small Front Setbacks

Up to 4 Stories

Multiplex, Core Townhouse, Core Courtyard, and Main Street Building

Forecourt, Shopfront, Terrace, and Gallery Frontage Types; Dooryard, Stoop, and Maker Shopfront Frontage Types on Side Street

2. Sub-Zone(s)

None

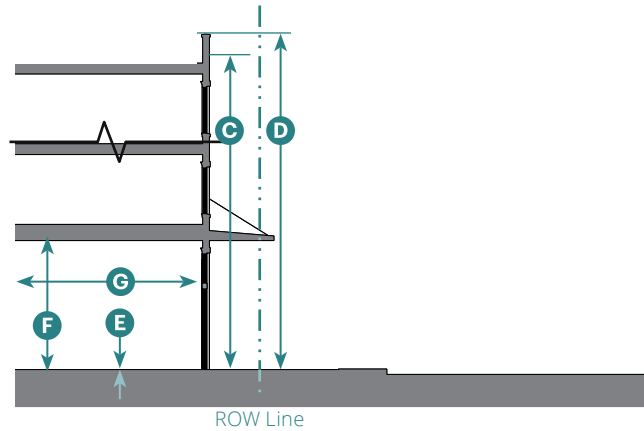
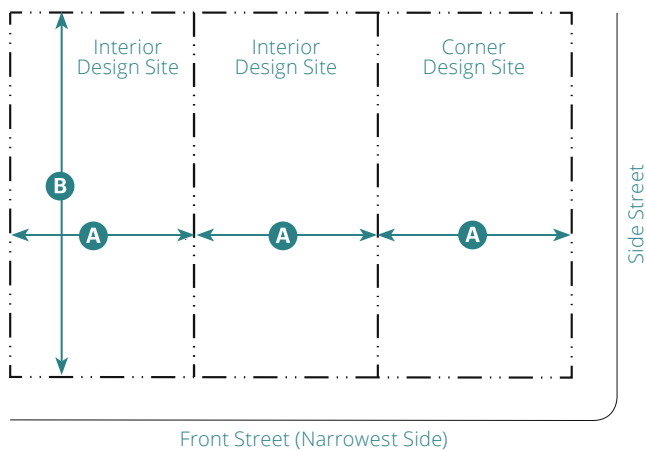

Key

--- ROW/ Design Site Line

Key

--- ROW Line

3. Building Types and Design Site Size

Allowed Building Types	Design Site ¹		Standards
	Width A	Depth B	
House-Scale			
Carriage House ²	N/A	N/A	05.040
Multiplex	60' min.	110' min.	05.130
Block-Scale			
Core Townhouse	18' min. ³	100' min.	05.140
Core Courtyard			05.160
L-shaped	75' min.	120' min.	
U-, O-shaped	100' min.	120' min.	
Main Street Building	25' min.	100' min.	05.170

Each design site shall have only one primary building type.

¹ Design sites of at least 3 acres or over 700' long or deep are required to include civic space and new street(s) per Chapter 8 (Specific to Large Sites).

² The Carriage House is not a primary building type.

³ Represents up to 2 stacked units

4. Building Form

Height	
Primary Building⁴	
Stories	4 max.
To Highest Eave/Parapet	36' max. C
Overall	50' max. D
Ground Floor Finish Level ⁵	E
Residential	6" min. ⁶
Non-Residential	6" max.
Ground Floor Ceiling	14' min. F
Accessory Structure(s)	1 max.
Footprint	
Max. Design Site Coverage	See standards in Chapter 5 (Specific to Building Types)
Depth, Ground-Floor Space	30' min. ⁷ G

⁴ See Chapter 5 (Specific to Building Types) for refinements to massing and height standards.

⁵ Common entries may be set at grade in compliance with local and federal accessibility standards.

⁶ Only on side street and at least 60' from front of design site

⁷ For habitable/occupiable space only

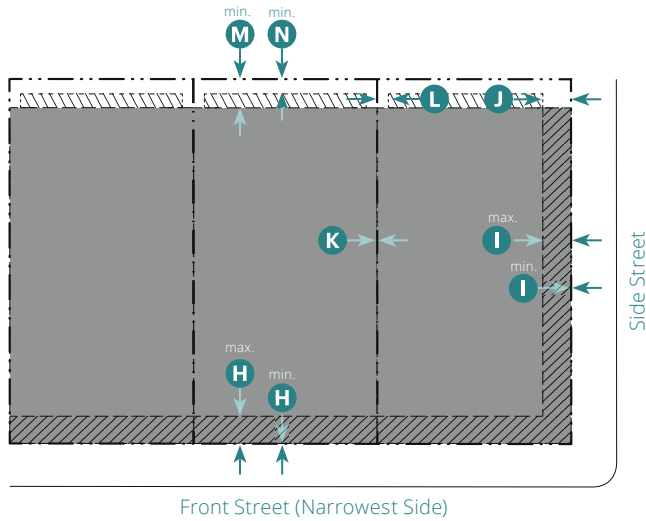

Key	Buildable Area
- - - ROW/ Design Site Line	Acc. Structures Only
- - - Building Setback Line	Facade Zone

5. Building Placement

Setback (Distance from ROW/ Design Site Line)⁸

Front (Facade Zone) ⁹		H
Interior Design Site	0' min.; 10' max.	
Corner Design Site	0' min.; 10' max.	
Side Street (Facade Zone)		
Primary Building ⁹	0' min.; 10' max.	I
Accessory Structure(s)	10' min.	J
Side		
Primary Building	0' min.	K
Adjacent to T3EN or Res'I Zone	10' min.	
Accessory Structure(s)	3' min.	L
Rear		
Primary Building	10' min.	M
Adjacent to T3EN or Res'I Zone	20' min.	
Accessory Structure(s)	5' min.	N

Building Facade

Facade Zone Defined By Main Building/Frontage Type	Front St.	Side St.
Total length of facade required within or abutting facade zone	80% min.	70% min.

Facade Design

All building facades shall be designed in compliance with Chapter 7 (Specific to Architectural Design).

Key	Encroachment Area
- - - ROW/ Design Site Line	Setback Line

5. Building Placement (Continued)

⁸Design sites with slopes $\geq 6\%$ shall comply with Section 04.050 (Slope Standards).

⁹Design to Topic 405 (Intersection Design Standards) of the Caltrans Design Standards, if greater than required setback of the zone

6. Encroachments

Encroachments into Minimum Setbacks

Encroachment Type	Front O	Side St. P	Side Q	Rear R
Private Frontages	X	X	X	X
Architectural Features	3' max.	3' max.	X	2' max.
Patio Covers	X	X	X	2' max.
Stairs/Ramps	3' max.	3' max.	X	2' max.

Ramps providing ADA or FHA visitability are allowed within setbacks but shall not encroach within public ROWs.

No encroachment allowed for Accessory Structures.

Fences, hedges, and other screen devices are allowed within setbacks as identified in Section 04.020 (Screening).

Encroachments into Public Right of Ways (ROW)

Encroachments at grade not allowed within a street ROW, alley ROW, or across a design site line.

Upper story encroachments, including the Gallery (06.120), on front and side street require 8' min. of vertical clearance.

Key	X = Not Allowed	N/A = Not Applicable
------------	-----------------	----------------------

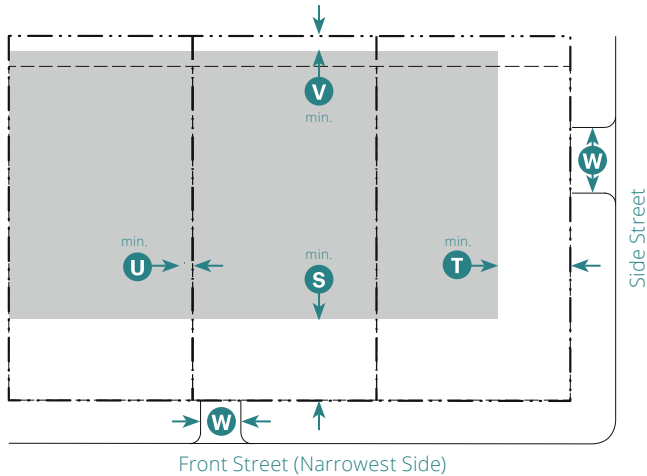

Key

- - - ROW/ Design Site Line
- - - Building Setback Line
- █ Parking Area

7. Parking		
Use Type	Vehicular Spaces ¹⁰	Bicycle Spaces
Residential Uses		
Studio or 1 Bedroom	1 min. per unit	1 min. per unit
2 or More Bedrooms	1.25 min. per unit	2 min. per unit
Non-Residential Uses per Building¹¹		
≤ 5,000 sf	0 min.	
≥ 5,000 sf	1.5 min. per 1,000 sf above first 5,000 sf	
Setback (Distance from ROW/ Design Site Line)		
Front	40' min. ¹²	S
Side Street	40' min.	T
Side	0' min.	U
Rear	5' min.	V
Driveway¹³		
Curb Cut/Width W		
1 Unit	12'	
2-6 Units	16'	
>6 Units	28'	
Non-Residential	18'	

Curb cut along alley shall not exceed allowed curb cut width.
 Driveways may be shared between adjacent design sites but shall not exceed allowed curb cut width.
 Front access not allowed on corner design sites.
 Bicycles may be parked anywhere on design site, in compliance with pedestrian and vehicular access standards.

7. Parking (Continued)

Parking spaces may be grouped with those on adjacent design sites and may be detached from design sites within the same block, in compliance with parking setbacks and access standards.

Where subterranean parking is provided, the minimum design site depth is allowed to be reduced to only the amount needed for the required rear building setback.

¹⁰ See Subsection 04.040.5 for additional standards.
¹¹ See Title 22, Article II (Zoning Districts and Allowable Uses) for the underlying zone's allowed uses and permit requirements.
¹² 10' min. allowed for parking courts of 6 or fewer spaces. See Figure 04.040.1 (Parking Court(s)).
¹³ See Subsection 22.04.040.8.B for additional standards.

8. Frontages

Allowed Private Frontage Type	Standards
Dooryard ¹⁴	06.060
Stoop ¹⁴	06.070
Forecourt	06.080
Maker Shopfront ¹⁴	06.090
Shopfront	06.100
Terrace	06.110
Gallery	06.120
Allowed Public Frontage Type	Standards
Avenue/Boulevard	04.060.C.2
Main Street	04.060.C.3

¹⁴ Only on side street

9. Signage

Allowed Sign Type

See Chapter 22.28 (Signs) for allowed signs and standards.

03.090 T5 Core Neighborhood (T5CN)



General note: the illustrations above are intended to provide a brief overview of the zone and are descriptive in nature.

1. Intent

A walkable neighborhood environment of large footprint, high-intensity housing choices supporting and within short walking distance of neighborhood-serving retail and services.

The following are generally appropriate form elements in the zone.

Block-Scale Buildings

Primarily Detached Buildings

Large Building Footprint

Small Front Setbacks

Small Side Setbacks

Up to 5 Stories

Multiplex, Core Townhouse, Terraced

Courtyard Building, and Core Courtyard

Porch Projecting, Porch Engaged,

Stoop, Forecourt, Shopfront, and

Terrace Frontage Types

2. Sub-Zone(s)

None

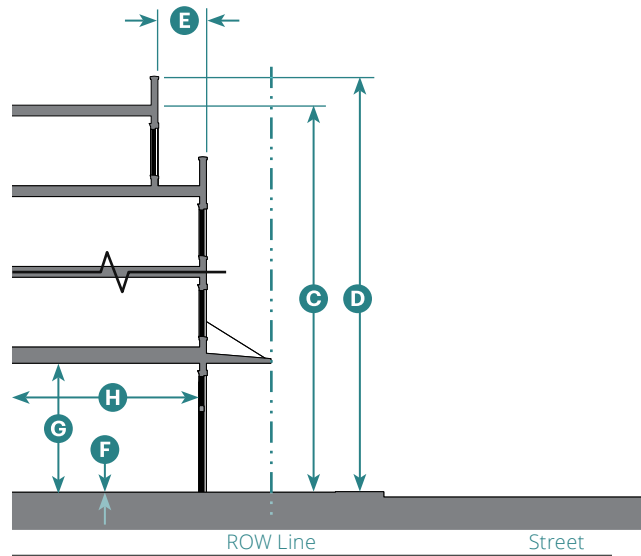
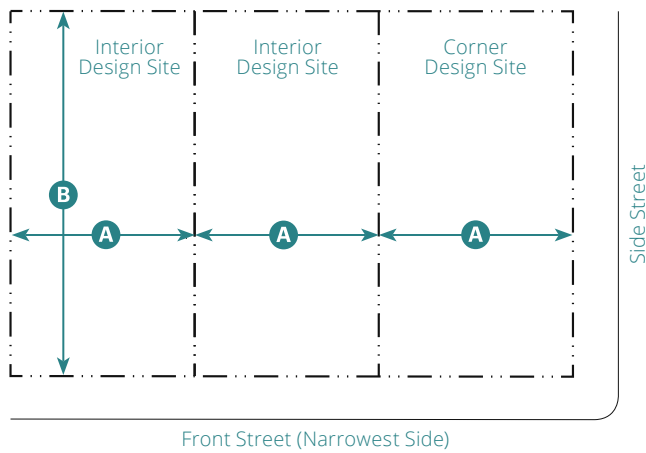

Key

--- ROW/ Design Site Line

Key

--- ROW Line

D. Building Form (Continued)			
3. Building Types and Design Site Size			
Allowed Building Types	Design Site ¹		Standards
	Width A	Depth B	
House-Scale			
Multiplex	75' min.	110' min.	05.130
Block-Scale			
Core Townhouse	18' min. ²	100' min.	05.140
Terraced Courtyard Building			05.150
<25% slope	Not Allowed		
>25% slope	150' min.;	200' min.;	
	200' max.	300' max.	
Core Courtyard			05.160
L-shaped	75' min.;	120' min.;	
	150' max.	200' max.	
U-, O-shaped	100' min.;	120' min.;	
	160' max.	220' max.	

Each design site shall have only one primary building type.

¹ Design sites of at least 3 acres or over 700' long or deep are required to include civic space and new street(s) per Chapter 8 (Specific to Large Sites).

² Represents up to 2 stacked units

4. Building Form		
Height		
Primary Building³		
Stories	5 max.	
To Highest Eave/Parapet	55' max.	C
Overall	60' max.	D
10' min. setback above 4th story; corner elements exempt		E
Ground Floor Finish Level ⁴		F
Residential	6" min.	
Non-Residential	6" max.	
Ground Floor Ceiling ⁶		G
Residential	9' min.	
Non-Residential	12' min.	
Accessory Structure(s)	1 max.	
Footprint		
Max. Design Site Coverage	See standards in Chapter 5 (Specific to Building Types)	
Depth, Ground-Floor Space	20' min. ⁵	H

³ See Chapter 5 (Specific to Building Types) for refinements to massing and height standards.

⁴ Common entries may be set at grade in compliance with local and federal accessibility standards.

⁶ For habitable/occupiable space only

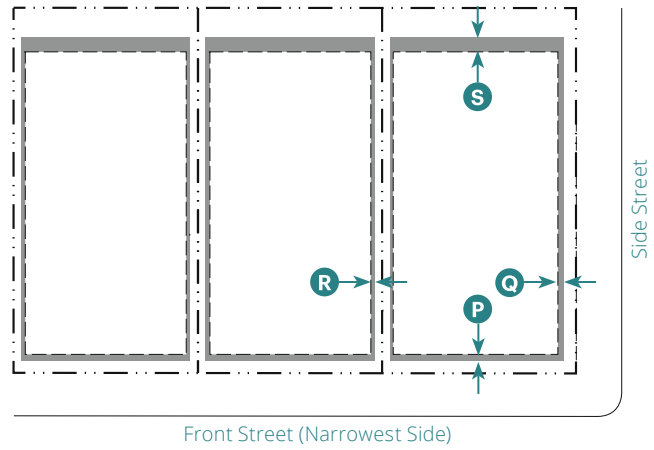
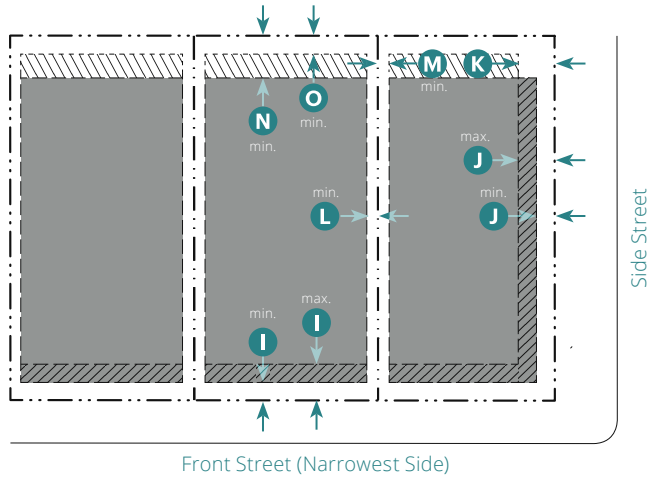

Key	Buildable Area
- - - - ROW/Design Site Line	Acc. Structures Only
- - - - Building Setback Line	Facade Zone

5. Building Placement

Setback (Distance from ROW/ Design Site Line)⁶

Front (Facade Zone)		I
Interior Design Site	5' min.; 12' max.	
Corner Design Site	5' min.; 12' max.	
Side Street (Facade Zone)		
Primary Building	5' min.; 12' max.	J
Accessory Structure(s)	12' min.	K
Side		
Primary Building	5' min.	L
Adjacent to T3EN or Res'I Zone	10' min.	
Terraced Courtyard Building	15' min.	
Accessory Structure(s)	5' min.	M
Rear		
Primary Building	15' min.	N
Adjacent to T3EN or Res'I Zone	20' min.	
Accessory Structure(s)	5' min.	O

Building Facade

Facade Zone Defined By Main Building/Frontage Type	Front St.	Side St.
Total length of facade required within or abutting facade zone	80% min.	70% min.

Facade Design

All building facades shall be designed in compliance with Chapter 7 (Specific to Architectural Design).

⁶ Design sites with slopes ≥ 6% shall comply with Section 04.050 (Slope Standards).

Key	Encroachment Area
- - - - ROW/Design Site Line	
- - - - Setback Line	

6. Encroachments

Encroachments into Minimum Setbacks

Encroachment Type	Front P	Side St. Q	Side R	Rear S
Private Frontages	5' max.	5' max.	X	X
Architectural Features	2' max.	2' max.	1' max.	5' max.
Patio Covers	X	X	1' max.	5' max.
Stairs/Ramps	2' max.	2' max.	1' max.	5' max.
Decks (24" Tall Max.)	X	5' max.	5' max.	20' max.

Decks more than 24" above existing grade may not encroach

Ramps providing ADA or FHA visitability are allowed within setbacks but shall not encroach within public ROWs.

No encroachment allowed for Accessory Structures.

Fences, hedges, and other screen devices are allowed within setbacks as identified in Section 04.020 (Screening).

Encroachments into Public Right of Ways (ROW)

Encroachments not allowed into a street ROW, alley ROW, or across a design site line.

Key	X = Not Allowed	N/A = Not Applicable
------------	-----------------	----------------------

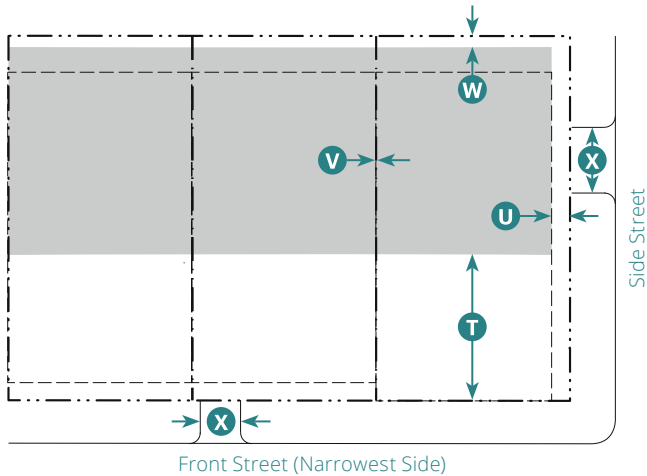

Key

- - - - ROW/ Design Site Line
- - - - Building Setback Line
- Parking Area

7. Parking

Use Type	Vehicular Spaces ⁷	Bicycle Spaces
----------	-------------------------------	----------------

Residential Uses		
Studio or 1 Bedroom	1 min. per unit	1 min. per unit
2 or More Bedrooms	1.25 min. per unit	2 min. per unit

Non-Residential Uses per Building ⁸		
≤ 1,500 sf	0 min.	
≥ 1,500 sf	Not Allowed	

Setback (Distance from ROW/ Design Site Line)

Front	40' min. ⁹	T
Side Street	15' min.	U
Side	5' min.	V
Rear	5' min.	W

Driveway¹⁰

Curb Cut/Width		W
1 Unit	12'	
2-6 Units	16'	
>6 Units	28'	
Non-Residential	18'	

Curb cut along alley shall not exceed allowed curb cut width.

Driveways may be shared between adjacent design sites but shall not exceed minimum allowed width.

Front access not allowed on corner design sites.

Bicycles may be parked anywhere on design site, in compliance with pedestrian and vehicular access standards.

7. Parking (Continued)

Parking spaces may be grouped with those on adjacent design sites and may be detached from design sites within the same block, in compliance with parking setbacks and access standards.

Where subterranean parking is provided, the minimum design site depth is allowed to be reduced to only the amount needed for the required rear building setback.

⁷See Subsection 04.040.5 for additional standards.

⁸See Title 22, Article II (Zoning Districts and Allowable Uses) for the underlying zone's allowed uses and permit requirements.

⁹ 10' min. allowed for parking courts of 6 or fewer spaces. See Figure 04.040.1 (Parking Court(s)).

¹⁰See Subsection 22.04.040.8.B for additional standards.

8. Frontages

Allowed Private Frontage Type	Standards
-------------------------------	-----------

Porch Projecting	06.040
Porch Engaged	06.050
Dooryard	06.060
Stoop	06.070
Forecourt	06.080
Shopfront ¹¹	06.100
Terrace	06.110

Allowed Public Frontage Type	Standards
------------------------------	-----------

Street	04.060.C.1
Avenue/Boulevard	04.060.C.2

¹¹ Only on side street

9. Signage

Allowed Sign Type

See Chapter 22.28 (Signs) for allowed signs and standards.

03.100 T5 Core Main Street (T5CMS)



General note: the illustrations above are intended to provide a brief overview of the zone and are descriptive in nature.

1. Intent

A walkable, vibrant district of large footprint, high-intensity mixed-use buildings and housing choices supporting ground floor retail, food and services.

The following are generally appropriate form elements in the zone.

Block-Scale Buildings	Core Courtyard and Main Street Building
Attached Buildings	Shopfront, Terrace, and Gallery Frontage Types; Stoop and Maker Shopfront Frontage Types on Side Street
Large Building Footprint	
No Front Setbacks	
No Side Setbacks	
Up to 5 Stories	

2. Sub-Zone(s)

None

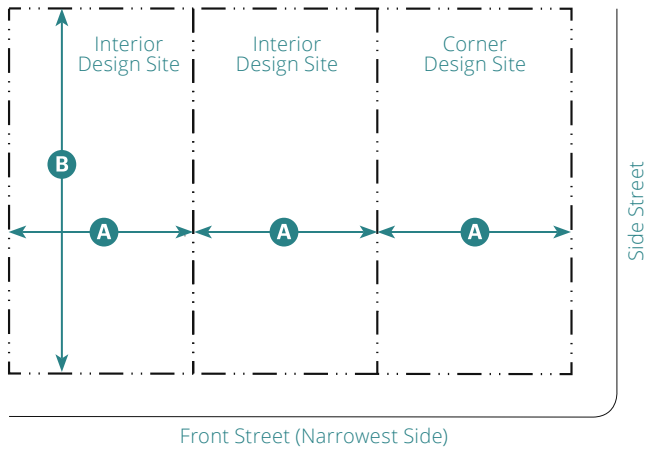

Key

--- ROW/Design Site Line

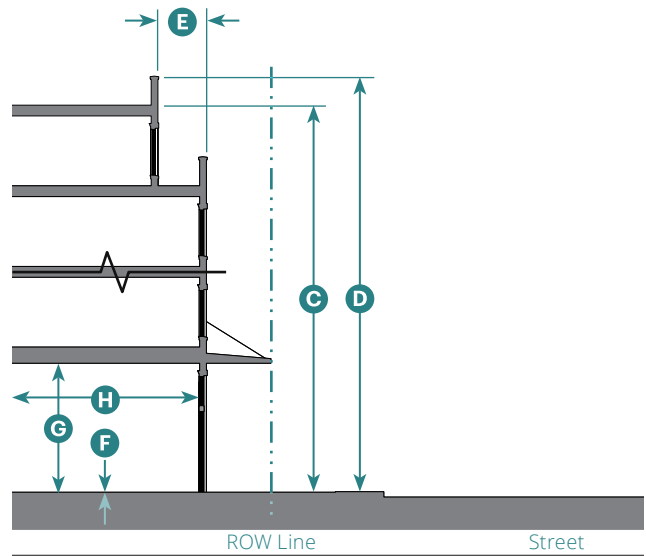

Key

--- ROW Line

D. Building Form (Continued)			
3. Building Types and Design Site Size			
Allowed Building Types	Design Site ¹		Standards
	Width A	Depth B	
House-Scale			
None			
Block-Scale			
Core Courtyard			05.160
L-shaped	75' min.; 150' max.	110' min.; 200' max.	
U-, O-shaped	100' min.; 200' max.	120' min.; 220' max.	
Main Street Building	25' min.	100' min.	05.170

Each design site shall have only one primary building type.

¹ Design sites of at least 3 acres or over 700' long or deep are required to include civic space and new street(s) per Chapter 8 (Specific to Large Sites).

4. Building Form		
Height		
Primary Building²		
Stories	5 max.	
To Highest Eave/Parapet	60' max.	C
Overall	65' max.	D
10' min. stepback above 4th story; corner elements exempt		E
Ground Floor Finish Level ³		
Residential	6" min.	F
Non-Residential	6" max.	
Ground Floor Ceiling	16' min.	G
Accessory Structure(s)	1 max.	
Footprint		
Max. Design Site Coverage	See standards in Chapter 5 (Specific to Building Types)	
Depth, Ground-Floor Space	30' min. ⁴	H

² See Chapter 5 (Specific to Building Types) for refinements to massing and height standards.

³ Common entries may be set at grade in compliance with local and federal accessibility standards.

⁴ For habitable/occupiable space only

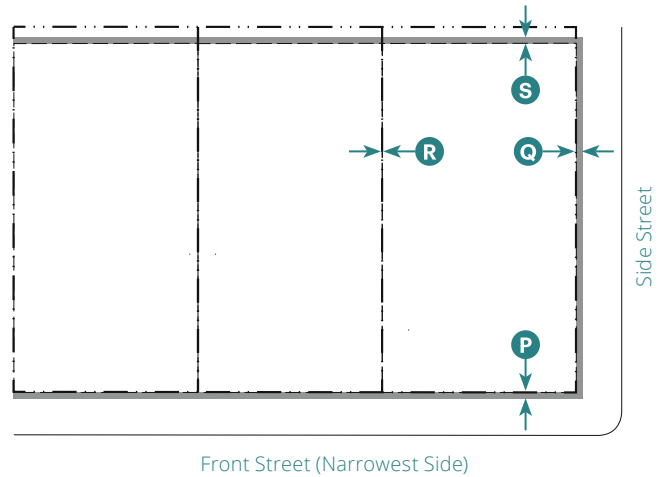
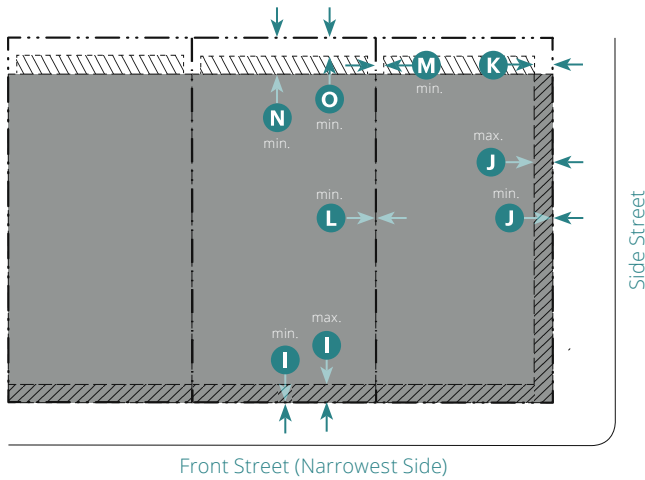

Key	Buildable Area
- · - · - ROW/Design Site Line	Acc. Structures Only
- - - Building Setback Line	Facade Zone

Key	Encroachment Area
- · - · - ROW/Design Site Line	
- - - Setback Line	

5. Building Placement

Setback (Distance from ROW/ Design Site Line)⁵

Front (Facade Zone) ⁶		I
Interior Design Site	0' min.; 10' max.	
Corner Design Site	0' min.; 10' max.	
Side Street (Facade Zone)		
Primary Building ⁶	0' min.; 10' max.	J
Accessory Structure(s)	5' min.	K
Side		
Primary Building	0' min.	L
Adjacent to T3EN or Res'I Zone	10' min.	
Accessory Structure(s)	3' min.	M
Rear		
Primary Building	10' min.	N
Adjacent to T3EN or Res'I Zone	20' min.	
Accessory Structure(s)	5' min.	O

5. Building Placement (Continued)

⁵ Design sites with slopes $\geq 6\%$ shall comply with Section 04.050 (Slope Standards).

⁶ Design to Topic 405 (Intersection Design Standards) of the Caltrans Design Standards, if greater than required setback of the zone

Building Facade

Facade Zone Defined By Main Building/Frontage Type	Front St.	Side St.
Total length of facade required within or abutting facade zone	90% min.	80% min.

Facade Design

All building facades shall be designed in compliance with Chapter 7 (Specific to Architectural Design).

6. Encroachments

Encroachments into Minimum Setbacks

Encroachment Type	Front P	Side St. Q	Side R	Rear S
Private Frontages	X	X	X	X
Architectural Features	2' max.	2' max.	X	2' max.
Patio Covers	X	X	X	2' max.
Stairs/Ramps	2' max.	2' max.	X	2' max.

Ramps providing ADA or FHA visitability are allowed within setbacks but shall not encroach within public ROWs.

No encroachment allowed for Accessory Structures.

Fences, hedges, and other screen devices are allowed within setbacks as identified in Section 04.020 (Screening).

Encroachments into Public Right of Ways (ROW)

Encroachments at grade not allowed within a street ROW, alley ROW, or across a design site line.

Upper story encroachments, including the Gallery (06.120), on front and side street require 8' min. of vertical clearance.

Key	X = Not Allowed	N/A = Not Applicable
------------	-----------------	----------------------

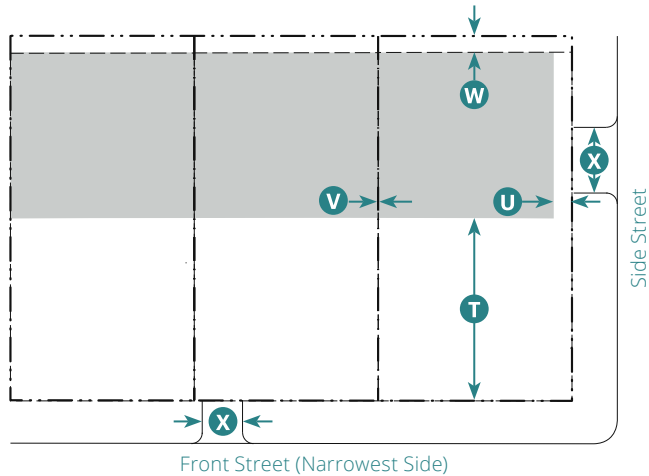

Key

- · - · - ROW/ Design Site Line
- - - Building Setback Line
- Parking Area

7. Parking		
Use Type	Vehicular Spaces ⁷	Bicycle Spaces
Residential Uses		
Studio or 1 Bedroom	.75 min. per unit	1 min. per unit
2 or More Bedrooms	1.25 min. per unit	2 min. per unit
Non-Residential Uses per Building⁸		
≤ 5,000 sf	0 min.	
≥ 5,000 sf	1.5 min. per 1,000 sf above first 5,000 sf	
Setback (Distance from ROW/ Design Site Line)		
Front	40' min. ⁹	T
Side Street	30' min.	U
Side	0' min.	V
Rear	5' min.	W
Driveway¹⁰		
Curb Cut/Width X		
1 Unit	12'	
2-6 Units	16'	
>6 Units	28'	
Non-Residential	18'	

Curb cut along alley shall not exceed allowed curb cut width.
 Driveways may be shared between adjacent design sites but shall not exceed minimum allowed width.
 Front access not allowed on corner design sites.
 Bicycles may be parked anywhere on design site, in compliance with pedestrian and vehicular access standards.

7. Parking (Continued)

Parking spaces may be grouped with those on adjacent design sites and may be detached from design sites within the same block, in compliance with parking setbacks and access standards.

Where subterranean parking is provided, the minimum design site depth is allowed to be reduced to only the amount needed for the required rear building setback.

⁷ See Subsection 04.040.5 for additional standards.
⁸ See Title 22, Article II (Zoning Districts and Allowable Uses) for the underlying zone's allowed uses and permit requirements.
⁹ 10' min. allowed for parking courts of 6 or fewer spaces. See Figure 04.040.1 (Parking Court(s)).
¹⁰ See Subsection 22.04.040.8.B for additional standards.

8. Frontages

Allowed Private Frontage Type	Standards
Stoop ¹¹	06.070
Maker Shopfront ¹¹	06.090
Shopfront	06.100
Terrace	06.110
Gallery	06.120
Allowed Public Frontage Type	Standards
Avenue/Boulevard	04.060.C.2
Main Street	04.060.C.3

¹¹ Only on side street

9. Signage

Allowed Sign Type
 See Chapter 22.28 (Signs) for allowed signs and standards.

03.110 Additional Height and Massing Requirements

These standards apply to buildings over three stories tall in T4CN.M, T4CMS, T5CN, and T5CMS:

1. **Specific to Parcels Less than 200 feet Deep or Wide: Transition to Adjacent Building Size.**

- A. Within 30 feet of the side or rear property line, the new building massing shall not exceed 25 feet in height overall and a maximum footprint length of the largest adjacent building. This massing allows for multiple volumes of this or smaller size. Behind the 25 foot height/massing, the building is allowed up to the maximum height allowed by the zone. See Figure 1 (Transition to Adjacent Building Size).

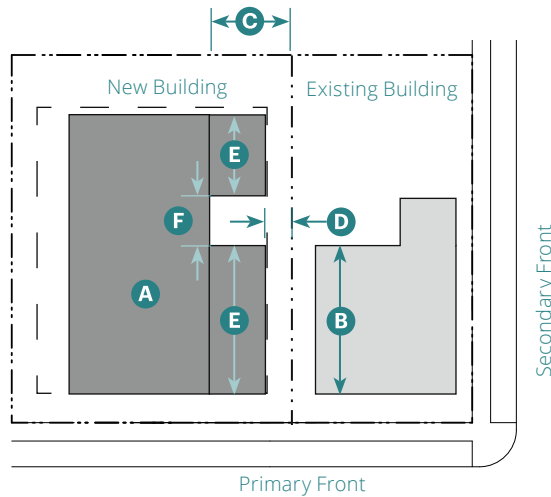

Figure 03.110.1:
Transition to Adjacent Building Size

- A** New Building (Max. Height Allowed by Zone) (e.g., 4 stories)
- B** Longest Dimension along Adjacent Side or Rear Property Line
- C** Required Transition Area: 30' min.
- D** Required Min. Setback
- E** New Building Transition to Existing Building's Height and Length (e.g., 2 stories)
- F** 15' min. Separation

2. **Specific to Parcels Adjacent to Existing Building not Built to Maximum Allowed Height.**

- A. Upper story stepback of 10 feet required on new building above top story of adjacent building. Where the adjacent building is single-story, the stepback is required on the 3rd story.
- B. New building to match horizontal length of massing of adjacent building within 10 percent measured along front of the building. See Figure 2 (Adjacent to Building Not Built to Maximum Allowed Height).

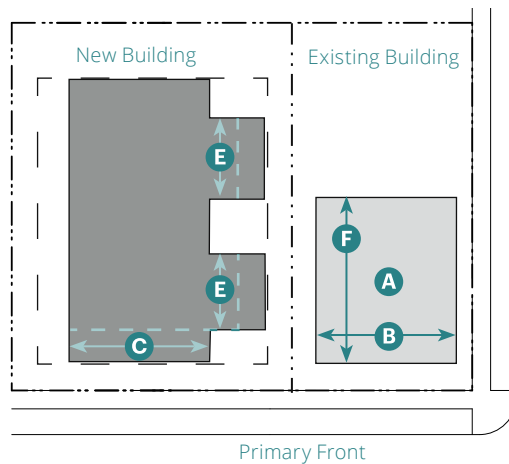



Figure 03.110.2:
Adjacent to Building Not Built to Maximum Allowed Height

- A** Existing Building
-  Upper Story Stepback: 10' Min.
- B** Existing Massing Length Measured along Adjacent Street
- C** New Facade(s) Allowed up to within 10% of Adjacent Facade
- D** 15' min. separation
- E** Total Combined Length Shall not Exceed Length of **F**

This page intentionally left blank

Chapter 4: General Design Site Standards

Sections:

04.010	Purpose
04.020	Screening
04.030	Landscaping and Lighting
04.040	Parking and Loading
04.050	Slope Standards
04.060	Public Frontage Standards
04.070	Privacy Standards
04.080	Environmental Protection Standards

04.010 Purpose

This Chapter provides standards to ensure that new development accomplishes the following:

1. Makes a positive contribution to the development pattern of the area;
2. New or altered structures are compatible with the design and use of existing structures on neighboring properties;
3. Respects the existing conditions of neighboring properties; and
4. Does not adversely affect neighboring properties, with "adversely affect" meaning to impact in a substantial, negative manner the habitability of these properties.

04.020 Screening

1. **Intent.** This Section provides standards for screening, fences, and walls for the protection of property, the enhancement of privacy, the attenuation of noise, and the improvement of the visual environment.
2. **Design Standards for Screening.** Except for wall- and ground-mounted equipment that is not visible from the public right-of-way or abutting design sites, all equipment shall comply with the following:
 - A. **Screening Height Maximums.** Screening shall not exceed the maximums identified in Table A (Maximum Screening Height).
 - B. **Screening Height Measurement.** Screening height shall be measured as the vertical distance between the finished grade at the base of the screen and the top edge of the screen material.

Table 04.020.A: Maximum Screening Height					
Zone	Item	Maximum Height Allowed			
		Front	Side St.	Side ²	Rear
T3EN, T3SN	Fences	3' max.	3' max.	6' max.	6' max.
	Free Standing Walls	3' max.	3' max.	6' max.	6' max.
	Landscaping ¹	4' max.	4' max.	No max.	No max.
T4SN.S, T4CN.M, T5CN	Fences	3' max.	3' max.	6' max.	6' max.
	Free Standing Walls	3' max.	3' max.	6' max.	6' max.
	Landscaping ¹	4' max.	4' max.	No max.	No max.
T4SMS.S, T4CMS, T5CMS	Fences	X	X	6' max.	6' max.
	Free Standing Walls	X	X	6' max.	6' max.
	Landscaping ¹	3' max.	3' max.	No max.	No max.

¹ Excludes trees

² Within front setback, maximum height of 3'

Key X = Not Allowed

3. Courtyard Screening

- A. Fences, walls and other screening installed to create a courtyard without a roof shall not exceed five feet in height and shall be set back a minimum of 10 feet from the front property line or back of sidewalk, whichever is the least.
- B. Landscaping installed in compliance with Section 04.030 (Landscaping and Lighting).

4. Screening on Retaining Walls.

The total height of screens and the retaining walls they are mounted on or attached to shall not exceed six feet.

5. Mechanical Equipment Screening

- A. The following mechanical equipment is exempt from screening:
 - (1) Free-standing or roof-mounted solar equipment.
- B. For new installation or relocation of existing mechanical equipment, the equipment shall be screened.
 - (1) **Roof-Mounted Equipment.** Building parapets or other architectural elements in the building's architectural style shall screen roof-mounted equipment.
 - (a) New buildings shall be designed to provide a parapet or other architectural element that is as tall or taller than the highest point on any new mechanical equipment to be located on the roof of the building; and
 - (b) For existing buildings with no parapet less than two feet in height, mechanical equipment shall be surrounded on all sides by an opaque screen wall as tall as the highest point of the equipment. The wall shall be architecturally consistent with the building and match the existing building with paint, finish, and trim cap detail.
 - (c) Plumbing and mechanical roof vents shall be grouped and located to not be visible from the opposite side of the front and/or side street, or abutting civic space.

(2) **Wall- and Ground-Mounted Equipment**

- (a) Equipment is not allowed between front or side street facades and the street.
 - (b) All screen devices shall be as high as the highest point of the equipment being screened.
 - (c) Equipment and screening shall be in compliance with the setbacks of the zone.
 - (d) Screening shall be architecturally compatible and include matching paint, finish, and trim cap of the building.
6. **Temporary Fencing.** Temporary fencing may be used to provide security for approved special events, construction sites, or vacant structures and land, which cannot otherwise be secured.
7. **Barbed Wire and Razor Wire.** Barbed wire and razor wire screening are not allowed.
8. **Safety.** Fences, walls, and other screening and landscaping, whether provided in compliance with the provisions of this Section or provided in addition to those provisions, must be in compliance with the site visibility triangle as determined by applying the criteria in Topic 405 (Intersection Design Standards) of the Caltrans Design Standards.

04.030 Landscaping and Lighting

1. **Intent.** This Section prescribes landscaping and lighting standards for protection and enhancement of the environmental and visual quality of the community, enhancement of privacy, and the control of dust.
2. **Required Landscaping.** The landscaping required by this Section shall be installed as part of the development or improvement(s) requiring the landscaping. Standards for landscaping in parking areas shall be in combination with Section 04.040 (Parking and Loading).
 - A. Landscaping materials shall be integrated into the required setbacks, stream and wetland buffers, and design of the selected private frontage type(s).
 - B. Landscape materials shall be applied to the planting areas identified for public frontage type(s).
3. **Required Lighting**
 - A. Site improvements, including lighting, shall be consistent with the selected Architectural Style for the primary building.
 - B. Lighting shall be provided in compliance with the following:
 - (1) All exterior lighting shall be designed, located, and lamped in order to prevent over lighting and light trespass.
 - (2) All parking lot lights shall be full cutoff luminaires, as certified by the manufacturer, with the light source directed downward and away from adjacent residences, in compliance with Section 24.04.410 (Parking Lot Lighting).
 - (3) Bollard lighting may be used to light walkways and other landscape features, but shall cast its light downward.
 - (4) Internally illuminated fascia, wall, roof, awning or other building parts are prohibited.
 - (5) All nonessential exterior lighting associated with non-residential uses shall be turned off within ½ hour after the close of business or when the non-residential use is not in use.

4. Design Standards

A. Allowed Landscaping Materials

- (1) Landscaping materials shall comply with the following:
 - (a) Shrubs, of at least one-gallon size;
 - (b) Ground cover instead of grass/turf; and/or
 - (c) Decorative nonliving landscaping materials including, but not limited to, sand, stone, gravel, wood or water may be used to satisfy a maximum of 25 percent of the required landscaping area.

B. Species Selection

- (1) Native and drought tolerant species are required to meet the minimum standards, in conformance with local the water district's water conservation standards.
- (2) Landscape selection shall include 70% California native vegetation, applicable to Marin County, in compliance with Water Use Classification of Landscape Species (WUCOL IV).
- (3) Landscaping shall be in compliance with local fire district.

C. Existing Vegetation

- (1) Tree removal shall be subject to Chapter 22.27 (Native Tree Protection and Preservation) and Chapter 22.62 (Tree Removal Permits).

D. Retaining Walls

- (1) Retaining walls within the front and/or side street façade zone(s) or visible from the public sidewalk adjoining the design site shall:
 - (a) Not exceed four feet in height as measured to the adjacent finished grade or sidewalk whichever is nearest;
 - (b) Include a landscape planter in front of the wall. The planter shall be at least 18 inches deep measured perpendicular to the wall; and/or
 - (c) Be finished with allowable wall material(s) of the selected architectural style for the primary building.
- (2) Retaining walls along the interior design site line that are beyond the front and/or side street façade zone(s) shall:
 - (a) Not exceed three feet as measured to the adjacent finished grade;
 - (b) Include a landscape planter in front of the wall. The planter shall be at least three feet deep measured perpendicular to the wall; and/or
 - (c) Be finished with allowable wall material(s) of the selected architectural style for the primary building.
- (3) Retaining walls along the rear design site line that are beyond the front and/or side street façade zone(s) shall:
 - (a) Not exceed eight feet as measured to the adjacent finished grade;

- (b) If exposed, include a landscape planter in front of the wall. The planter shall be at least three feet deep measured perpendicular to the wall;
 - (c) Be finished with allowable wall material(s) of the selected architectural style for the primary building; and/or
 - (d) Not require landscaping or wall material finish(es) if within the building and not exposed.
- E. **Maintenance.** Required landscaping shall be maintained in a clean and healthy condition. This includes pruning, weeding, removal of litter, fertilizing, replacement of plants when necessary, and the appropriate watering of all landscaping.
- F. **Recycling/Refuse Enclosures**
- (1) Enclosures shall not be located within the required front setback.
 - (2) See Section 22.20.100 (Solid Waste/Recyclable Materials Storage) for standards.

04.040 Parking and Loading

1. **Intent.** This Section prescribes standards for motor vehicle and bicycle parking areas, loading and access drives, and standards for reducing motor vehicle trips per capita to and from development. These standards are intended to ensure that new development accomplishes the following:
 - A. Consistency with the intended physical character of walkable environments;
 - B. Provision of bicycle parking to increase bicycle trips and reduce motor vehicle trips per capita; and
 - C. Appropriately limits, screens, and landscapes motor vehicle parking areas to protect and enhance the environmental and visual quality of the community, enhance privacy, attenuate noise, and control dust.
2. **On-site parking.** On-site parking is allowed in all zones subject to the standards in this Section.
3. **Bicycle Parking Standards.** Bicycle parking shall be provided in compliance with the standards of the zone.
4. **General Vehicular Parking Standards**
 - A. **Sharing of On-Site Parking.** Sharing of parking between different uses and developments is allowed.
5. **Number of Motor Vehicle Parking Spaces Required**
 - A. **Required Spaces.** The minimum number of parking spaces required is listed in Subsection 7 of the zone. For any use not addressed in Subsection 7, parking shall not exceed a ratio equivalent to the average peak parking occupancy rate for the most comparable use in the Institute of Transportation Engineers Parking Generation Manual.
 - B. **Required Number of Parking Spaces**
 - (1) When calculating the required number of parking spaces, numbers shall be rounded up to the closest whole number.
 - (2) For parking systems that stack individual vehicles, each vehicle accommodated by the stacker counts as an individual parking space.

- (3) **Calculating Required Parking for a Mixed-Use Development.** For a building with residential and non-residential uses, shared parking shall be calculated as follows. The sum of the required parking for the two use types as stated in Subsection 7 of the zone shall be divided by the factor listed in Table A (Shared Parking Factor for Two Uses). The required number of parking spaces shall be rounded up to the closest whole number.

	Residential	Lodging	Office	Retail
Residential	1.0	1.1	1.4	1.2
Lodging	1.1	1.0	1.7	1.3
Office	1.4	1.7	1.0	1.2
Retail	1.2	1.3	1.2	1.0

- C. **Exception in the Event of Changes of Use or Alterations to Existing Buildings or Structures.** If an existing building or structure is altered or existing land uses are changed, the existing number of parking spaces on a property may be retained, even if the resulting building, structure or land use would ordinarily be subject to a lower maximum parking allowance.
- 6. **Electric Vehicle Charging.** Electric vehicle charging facilities shall be provided in compliance with CA Green Standards Building Code, Title 24, Part 11.
- 7. **Traffic-Reducing Parking Standards**
 - A. **Carshare Parking Spaces**
 - (1) Carshare parking spaces shall be provided in the amounts specified in Table B (Required Carshare Parking Spaces).

Residential Uses	Carshare Parking Spaces Required
0-49 units	None
50-100 units	1
101 or more units	2 + 1 per additional 200 units
Office/Research & Development Uses	Carshare Parking Spaces Required
≤ 10,000 sf	None
> 10,000 sf	1 per 10,000 sf

- (2) Required carshare space or spaces shall be designed in a manner that will make the spaces accessible to non-resident subscribers from outside the building as well as building residents.

- B. **Carpool Spaces.** If parking is provided at a development, parking spaces reserved for use by carpool/vanpool vehicles shall be designated in preferred locations (including, but are not limited to, closest to building entries). The locations of these spaces shall be approved by the County. The minimum number of carpool spaces required is listed in Table C (Required Carpool Parking Spaces).

Table 04.040.C: Required Carpool Parking Spaces	
Office/Research & Development Uses	Carpool Parking Spaces Required
≤ 40 parking spaces	None
> 40 parking spaces	10% of the total number of spaces
Other Uses	Carpool Parking Spaces Required
All Other Uses	None

8. **Parking Spaces, Design and Layout**

- A. **Access.** On-site parking areas shall be accessed per the following:
 - (1) On-site parking shall be designed with an appropriate means of vehicular access to a street or to an alley to cause the least interference with traffic flow.
 - (2) Ingress to and egress from parking spaces shall be from an on-site aisle or driveway, directly from the front, side street, public alley, or rear lane.
 - (3) On-site loading space(s) shall be provided in accordance with Section 24.04.370 (Required Loading Spaces).

B. **Driveways**

- (1) **Access to Driveways**
 - (a) Driveway access to and from developments onto streets shall be by forward or reverse motion of the vehicle; and
 - (b) Minimum 30 feet separation between driveways for all uses except developments of two or fewer dwelling units.
- (2) **Number of Driveways.** Table D (Number of Driveways) specifies the maximum number of driveways for a design site.
- (3) Driveways shall be setback from design site lines as follows:
 - (a) For front access, minimum two feet from side design site lines; and/or
 - (b) For side street access, no less than the minimum rear parking setback per the zone; and/or
 - (c) Where driveway access is shared by abutting design sites, Subsections (a) and (b) above do not apply; minimum two feet from building(s), and in compliance with Chapter 24.04.II Driveways.
- (4) Driveways shall extend to and include the area between the design site line and the edge of the street pavement.
- (5) The design and construction of all on-site parking access drives shall be in compliance with Chapter 24.04.II Driveways.

Table 04.040.D: Number of Driveways

Lot Frontage (Corner Parcel Applies Same Requirements as Side Street)	Maximum Number of Driveways
Up to 150'	1
150' to 299'	2
Each additional 300' after 299'	1

- C. **Parking Techniques.** As allowed in Table 09.030.A (Adjustments to Standards for Design Sites Less Than 6% Slopes) and Table 09.030.B (Adjustments to Standards for Design Sites Over 6% Slopes), the following techniques may be applied individually or in combination:
- (1) **Tandem Parking.** Parking spaces are arranged in a series up to the maximum allowed in Table 09.030.A (Adjustments to Standards for Design Sites Less Than 6% Slopes) and Table 09.030.B (Adjustments to Standards for Design Sites Over 6% Slopes). Tandem parking is allowed in all zones for all uses, subject to on-site management.
 - (2) **Parking Court.** Parking spaces in groupings of up to 20 covered or uncovered spaces or individual garages not in a podium configuration. The minimum width of the parking court is 60 feet measured parallel to the adjacent street/right-of-way. The parking court is accessed from the adjacent street/right-of-way and the maximum width of the entrance to the parking court is determined by Subsection 7 of the zone.
 - (3) **Podium Parking.** Parking spaces are located in an at-grade garage under the rear and/or interior side of the building or under all of the building except for the required ground floor habitable space. The garage has occupiable space above the garage level. The podium is not visible or exposed along the front or side street building facades.
 - (4) **Subterranean Parking.** Parking spaces are located below the adjacent finished grade of the building.
 - (5) **Stacked Parking System.** Parking spaces are arranged in a system that provides two to three spaces in the horizontal area of one space. This type of system is within a podium parking garage.

Figure 04.040.1: Parking Court(s)

Small Parking Court (8 or fewer Spaces)

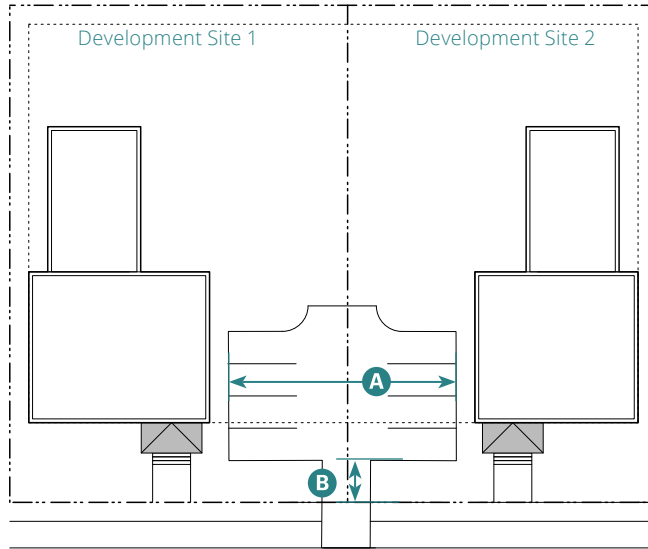

Large Parking Court (9 or more Spaces)

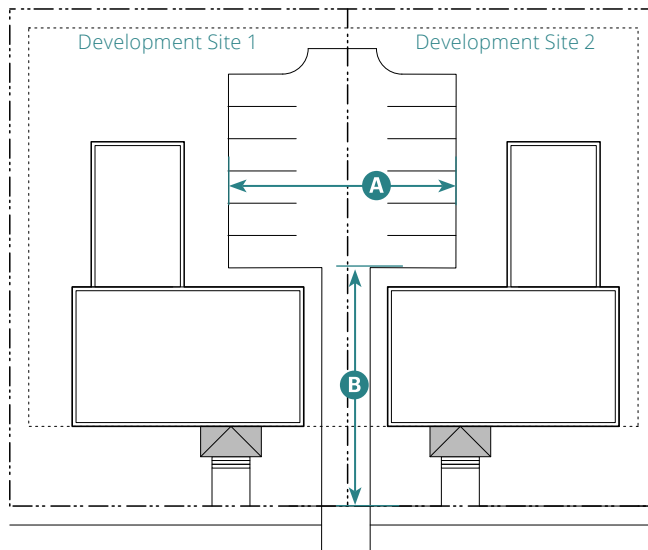

---	Development Site Line		
----	Sidyard Building Setback Line		
A	Minimum Width of the Parking Court, measured parallel to the adjacent street/right-of-way		
B	Minimum Parking Court Setback:	Small Parking Court (8 or fewer spaces)	10' min.
		Large Parking Court (9 or more spaces)	Behind required ground floor habitable space required in Subsection 4 of the zone

- D. **Identification as to Purpose and Location.** On-site parking areas of four or more spaces shall include painted lines, wheel stops, or other methods of identifying individual parking spaces and loading areas, while distinguishing such spaces from aisle and other circulation features.
- E. **Materials**
- (1) All on-site parking areas and driveways shall be surfaced only with materials identified in Section 24.04.300 (Surfacing--General) and Section 24.04.320 (Surfacing Outside City-centered Corridor and Village Areas).
 - (2) Parking area surfacing materials shall consist of the following materials:
 - (a) Gravel, crushed granite, "grasscrete";
 - (b) Recycled materials including, but not limited to, glass, rubber, used asphalt, brick, block and concrete; or
 - (c) A combination of the above materials.
- F. **Landscaping.** The landscaping standards identified in Table E (Required Parking Lot Landscaping) shall be applied with the standards of Section 04.020 (Screening) and Section 04.030 (Landscaping and Lighting).
- (1) Parking and loading areas shall be screened from adjacent residential zones by a six foot wall, fence, or evergreen.
 - (2) Screening is not required when parking area(s) is adjacent to an alley.
 - (3) Landscaping areas shall integrate stormwater management features.
 - (4) For portions of parking areas covered by photo-voltaic solar collectors that also function as shade structures, the minimum standard for trees does not apply.
- G. **Location**
- (1) Location of on-site parking is regulated by the required setbacks in Subsection 7 of the zone and the following:
 - (a) Parking lots with 11-20 spaces shall be separated at least by five feet from buildings to make room for a sidewalk, landscaping, and/or other planting between the building and the parking area;
 - (b) Parking lots with more than 20 spaces shall be separated by at least 12 feet from buildings to make room for a sidewalk, landscaping, and other planting between the building and the parking area; and
 - (c) The required separation may be eliminated to the rear of buildings in areas designed for unloading and loading of materials.

Table 04.040.E: Required Parking Lot Landscaping

Number of Parking Spaces	Percent of Gross Parking Area Required to be Landscaped
10 or fewer	None
11 to 20	5' min. wide planter along property line
21 to 50	5%; 5' min. wide planter between every 5 spaces, property line, and building(s)
51 and over	10%; 5' min. wide planter between every 5 spaces, property line, and building(s)

General Landscaping

Required Border	6" high curb or equivalent
Border and Stormwater	Curb or equivalent shall include breaks every 4" to provide drainage to retention and filtration areas.
Car Overhangs	Shall be prevented by stops
Required Quantity	1 tree per every 10 parking spaces, beginning at 11 total spaces
Tree Well Size ¹	5' min. in any direction
Tree Can Size	15 gallon min.
Tree Box Size	20% of required trees shall be 24" min.
Tree Caliper	1" min.
Tree Height at Installation	7' min. vertical clearance
Tree Characteristics	Tree canopy
Location	Evenly spaced throughout parking lot to provide uniform shade

¹Any vehicle overhang requires the minimum planter area width to be expanded by an equivalent dimension.

- H. **Size of Parking Lot.** Parking lots larger than 10,000 square feet in size shall be broken down into smaller parking areas with planted landscape areas with a minimum width of 15 feet between them to minimize the perceived scale of the total field of stalls.

04.050 Slope Standards

1. **Intent.** This Section provides the standards for development in all zones on design sites with sloped topography. For the purposes of this Section, sloped topography is any slope of six percent or more.
 - A. Table A (Maximum Amount of Sloped Areas Allowed to be Developed) identifies the amount of developable area for sloped portions of design sites. This, in combination with the standards in this Section and the maximum allowed building footprint shall be applied to the design of the sloped portions of design sites. Refer to Subsection 10.030.1 for instructions on determining the sloped portion(s) of a site.
 - B. Developments subject to Chapter 8 (Large Sites) requiring new streets shall be in compliance with a maximum grade of 15 percent. Refer to Subsection 10.030.1 for instructions on determining the sloped portion(s) of a site.
 - C. Only the Pocket Neighborhood (05.120) and Terraced Courtyard Building (05.150) Building Types are allowed in the >25% category per the amount of developable area identified in Table A.

Table 04.050.A: Maximum Amount of Sloped Areas Allowed to be Developed

Portions of Design Site with Existing Slope	Development Site ^{1,2}			Previously Developed >1 acre
	Greenfield			
	Up to 1 acre	1 to 3 acres	>3 acres	
0–5.99%	100% max.	100% max.	100% max.	Not to exceed previously developed footprint
6–9.99%	100% max.	70% max.	70% max.	
10–14.99%	100% max.	50% max.	25% max.	
15–25%	75% max.	25% max.	10% max.	
> 25%	10% max.	10% max.	10% max.	

¹ In compliance with the setbacks of the zone, required on-site open space, this Section, and the maximum building footprint standards in Chapter 5 (Building Type Standards).

² In compliance with required amount of civic space identified in Subsection 08.040.5.

2. **Building Height**

- A. **Maximum Building Height.** Building height is regulated by Subsection 4 of the zone. The maximum allowed height of a building shall follow the existing topography of the design site to ensure that each building is in compliance with the allowed building height.
- (1) Figure 1 (Site Grading for Small-to-Medium Detached and Attached Building Forms) and Figure 2 (Site Grading for Large or Attached Building Forms) in this Section illustrate allowed and non-allowed site grading methods.
- B. **Exposed Basements.** Basements do not count toward the maximum stories allowed in the zone if less than half of the basement's story height is below the average adjacent finished grade.
3. **Topography and Required Location of Primary Building.** Sloped topography can present issues with locating the primary building on a design site in compliance with Subsection 5 of the zone. Table 09.030.A (Adjustments to Standards for Design Sites Less Than 6% Slopes) and Table 09.030.B (Adjustments to Standards for Design Sites Over 6% Slopes) identify allowed administrative variations for issues arising from sloped topography, subject to the required findings in these Tables.

4. **Parking, Topography and Required Location**

- A. Parking lot slopes shall not exceed 5% (after grading) and may be subject to additional limits per Americans with Disabilities Act (ADA).
- B. Sloped topography can present issues with locating parking on a design site in compliance with Subsection 7 of the zone. Table 09.030.A (Adjustments to Standards for Design Sites Less Than 6% Slopes) and Table 09.030.B (Adjustments to Standards for Design Sites Over 6% Slopes) identify allowed administrative variations for issues arising from sloped topography, subject to required findings.

5. **Grading or Regrading of Design Sites.** When existing design site topography is proposed to be changed, grading shall not result in any of the following:

- A. Creation of retaining walls or blank walls taller than four feet within required front or side street facade zones;
- B. Retaining walls on side design site lines taller than four feet as measured from lowest finished grade to top of wall;
- C. Retaining walls taller than 10 feet not within the building footprint along rear design site line or side design site line within the rear setback;
- D. Building(s) that do not reflect the existing topography of the design site;
- E. Terraced design sites that result in a vertical difference of more than four feet between the adjacent right-of-way and the finished grade of the design site;
- F. Grading beyond the building pad(s) and the required access drive(s);
- G. Cut exceeding 16 feet in height from top to toe;
- H. Cut slope exceeding two horizontal to one vertical;
- I. Graded slopes exceeding 30%;
- J. Graded slopes not contoured to blend with existing terrain, such that proposed cuts and fills exceed one foot of added/subtracted rise for each one and one-half feet of run;
- K. Graded slopes not screened from view under or behind buildings with landscaping or natural topographic features; or
- L. Graded slopes not revegetated with native groundcovers or shrubs.

6. **Streets**

- A. New roads, including parking access and drive aisles, shall not intrude into locations where slopes exceed 15%, or with identified seismic or geologic hazards, or within 50 feet of creek centerline, except where necessary to access a one-acre or larger developable area that would be otherwise inaccessible.

7. **Drainage Facilities.** All proposed drainage facilities shall be set back from creeks, channels or other major waterways at least 20 feet from the top of bank or 20 feet plus twice the channel depth measured from the toe of the near embankment, whichever is greater.

8. **Massing.** Buildings on sloped design sites shall reflect the existing topography of the design site.
 - A. Buildings with footprints 36 feet wide or less shall have a simple water table element or change in material between the basement and the ground floor.
 - B. Buildings with footprints wider than 36 feet and 2.5 stories or taller shall have a minimum of one story tall defined base. The base shall be defined through the use one of the following methods:
 - (1) Change in material;
 - (2) A continuous horizontal band between the base and upper floors; and/or.
 - (3) Use of a continuous shopfront frontage.
 - C. All design shall be in compliance with the selected style for the building(s) in Chapter 7 (Architectural Design Standards).
9. **Frontage.** Along front and side street facades, the primary building on each design site shall be designed in compliance with the standards for ground floor private frontage as required by Subsection 8 of the zone.
10. **Administrative Relief.** Section 09.030 (Adjustments to Standards) provides for administrative variations from the standards in this Section due to topographic constraints.

Figure 04.050.2: Site Grading for Small-to-Medium Detached and Attached Building Forms

Allowed Site Grading. The following examples apply to the House, Duplex, Cottage Court, Fourplex, Neighborhood Townhouse, Neighborhood Courtyard, Pocket Neighborhood, and Multiplex Building Types.

Allowed. Grading that results in each new modified building stepping and reflecting the topography of the parcel or design sites, and that connects each building with the adjacent street and public realm.

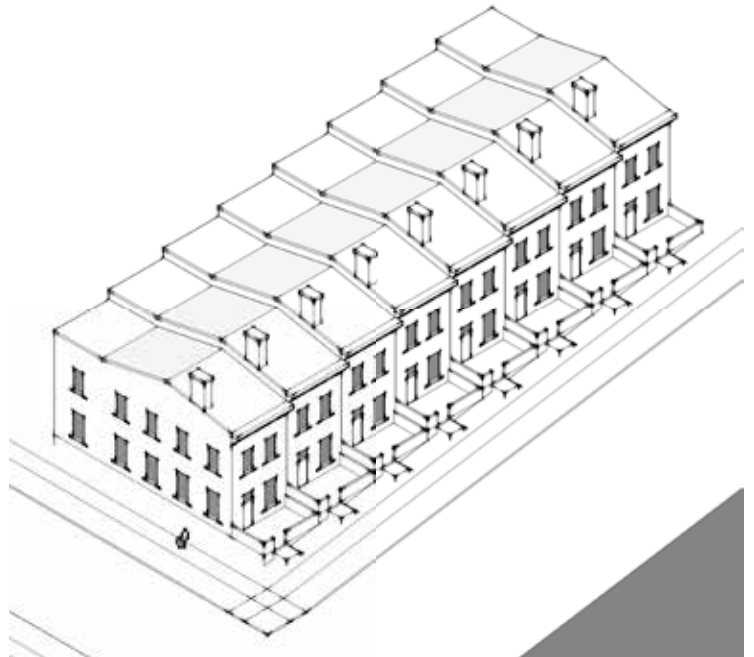
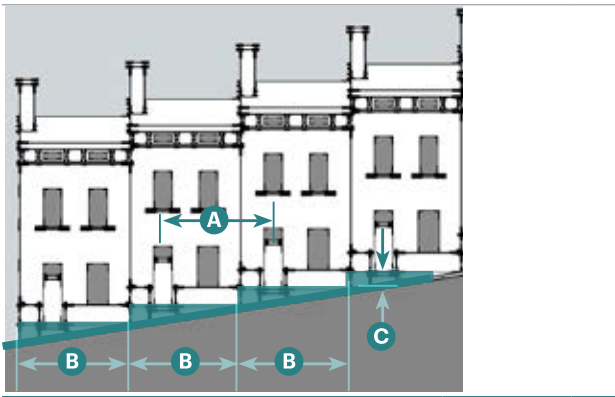

- Distance between building entries on slopes greater than 10% shall not exceed 50'. A
- Building footprint width steps with slope. B
- Finished grade of terraced design site is less than 4 feet from the adjacent street/right-of-way. C

Not Allowed. Grading that results in each new or modified building not following and reflecting the topography of the parcel or design sites, and disconnects each building from the adjacent street and public realm.

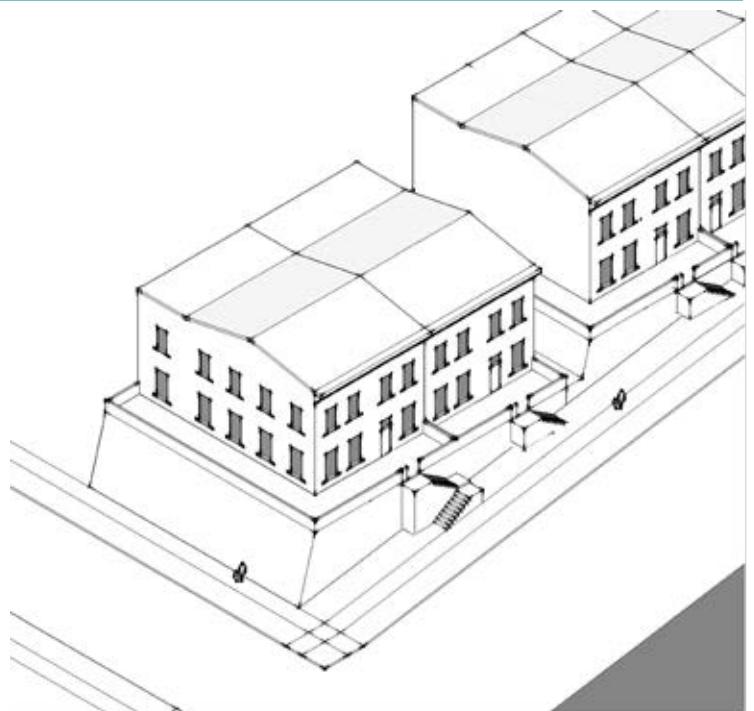
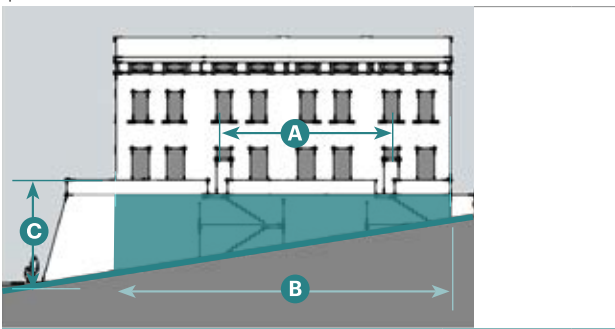

- Distance between building entries on slopes greater than 10% exceeds 50'. A
- Building footprint width does not step with slope. B
- Finished grade of terraced design site is more than 4 feet from the adjacent street/right-of-way. C

Figure 04.050.3: Site Grading for Large or Attached Building Forms

Allowed Site Grading. The following examples apply to the Multiplex, Core Townhouse, Core Courtyard, and Main Street Building Types.

Allowed. Grading that results in each new or modified building fronting on the adjacent street(s), and that connects the building facades to the adjacent street and public realm, and avoids large blank retaining walls.

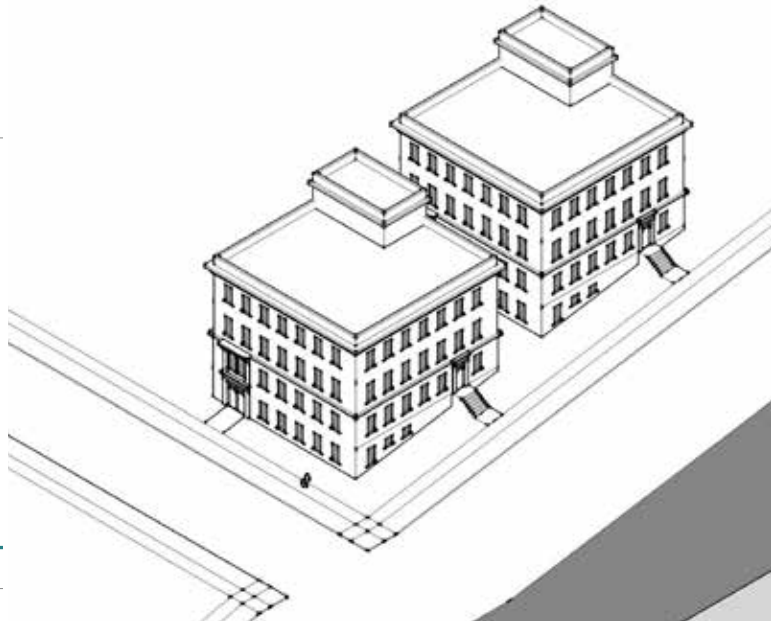
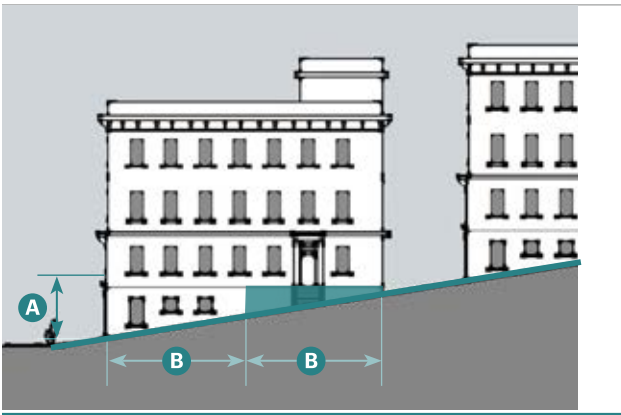

Slope is used to create a ground floor along street or civic space. Finished grade of terraced design site is less than 4 feet from the adjacent street/right-of-way. **A**

Building footprint steps with slope through a partial ground story. **B**

Not Allowed. Grading that disconnects new and modified building facades from the adjacent public realm, and results in large retaining walls.

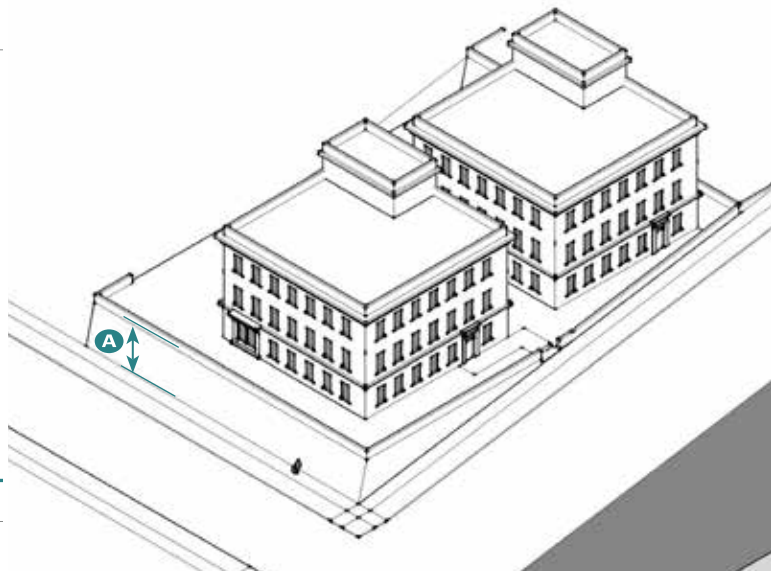
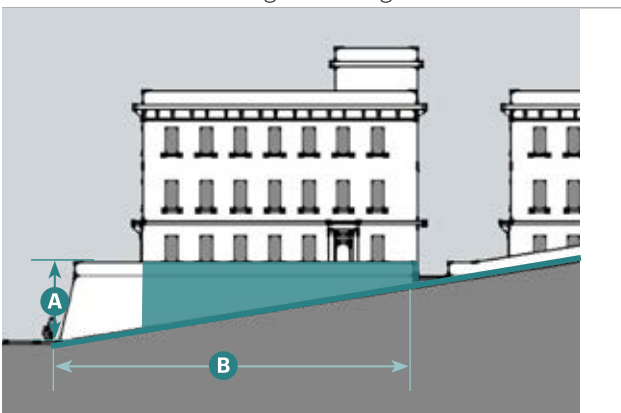

Height does not create building with frontage and entries along adjacent streets; terraced design site is more than 4 feet from adjacent sidewalk/street/right-of-way. **A**

Building footprint does not step with slope. **B**

04.060 Public Frontage Standards

1. **Intent.** Public frontage types provide a coordinated approach to design standards for the area between each design site's private frontage(s) and the adjoining right-of-way or private driveway easement. Public frontage types consist of planters, walkways, curbs, planters, and planting, as illustrated in Table B (Public Frontage Types Overview).
2. **Required Improvements.** The public frontage along the design site(s) shall be improved per Table A (Required Improvements) and the development scenario that applies to the project.

Table 04.060.A: Required Improvements

Required Improvements	Development Scenario			
	Infill Design Site on Existing Block	Two or More Design Sites on Existing Block	More Than Half of Existing Block	New Block(s)
	Development consists of one design site.	Development consists of two or more design sites that are less than half of the block face.	Development consists of two or more design sites that are more than half of the block face.	Development creates one or more new blocks.
a. Sidewalk. Add missing segment(s) along abutting front and/or side street.	R	R	R	R
b. Sidewalk. Repair uneven segments along abutting front and/or side street.	R	R	R	N/A
c. Street trees. Add street trees along abutting front and/or side street where there is adequate room to also maintain sufficient width for traffic lanes, pedestrian sidewalks, and bicycle facilities. See Subsection 04.030.4.A.(2).	R	R	R	R
d. Crosswalk improvements. Add crosswalk.	X	X	X	R; Including adjacent and new intersection(s).
e. Bicycle facilities. Add bicycle facilities required in Bicycle and Pedestrian Master Plan.	X	X	R	R; Including bike lanes.

Key R = Required X = Not Required

3. **Design Standards for Public Frontages.** Public frontages shall be designed and maintained in compliance with the following standards:
 - A. The required elements are identified in and shall be configured according to Table C (Public Frontage Assemblies).
 - B. Planting and landscape selection shall be in compliance with Water Use Classification of Landscape Species (WUCOL IV).

4. **Pedestrian Crossings**

- A. **Curb Ramps.** Perpendicular corner curb ramps with a separate ramp installed in each direction are required.
- B. **Crosswalks.** Crosswalks shall be designed per the County's applicable standards and applicable State guidelines and standards.

(1) Standard Crosswalk.

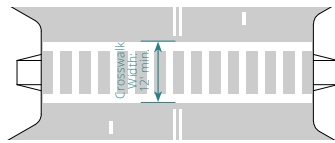

5. **Allowed Public Frontage Types**

- A. **Street.** The Street Frontage includes raised curbs drained by inlets with sidewalks separated from vehicular lanes by individual or continuous planters. Landscaping consists of street trees of a single or alternating species aligned and spaced at 35' intervals on average.
- B. **Avenue/Boulevard.** The Avenue/Boulevard Frontage includes raised curbs drained by inlets with wide sidewalks separated from the vehicular lanes by a continuous planter, and parking on both sides. Landscaping consists of single or double rows of a single or alternating tree species aligned and spaced at 35' intervals on average.
- C. **Main Street.** The Main Street Frontage includes raised curbs drained by inlets with very wide sidewalks along both sides separated from the vehicular lanes by individual tree wells with grates. Landscaping consists of a single tree species aligned and spaced at 35' intervals on average.

Table 04.060.B: Public Frontage Types Overview



Table B (Public Frontage Types Overview) provides an overview of the allowed public frontage types in or abutting each zone.

Public Frontage Types	Specific Standards	T3			T4			T5	
		EN	SN	SN.S	CN.M	SMS.S	CMS	CN	CMS
Street	04.060.C.1	P	P	P	P	X	X	P	X
Avenue/Boulevard	04.060.C.2	X	X	X	P	X	P	P	X
Main Street	04.060.C.3	X	X	X	X	P	P	X	P

Key P = Allowed X = Not Allowed

Table 04.060.C: Public Frontage Assemblies

Table C (Public Frontage Assemblies) identifies the required elements and dimensions of each public frontage type.

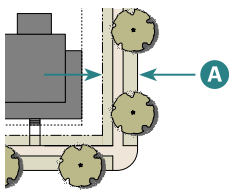
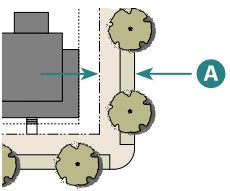
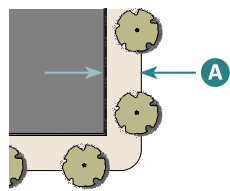
	Street 04.060.C.1	Avenue/Boulevard 04.060.C.2	Main Street 04.060.C.3
Assembly. The type and dimension of curbs, walkways, and planters.			
			
Total Width	A 11' min.	A 13' min.	A 16' min.

Note: See below for required elements of each assembly

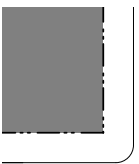
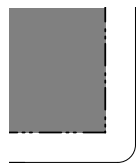
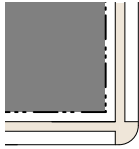
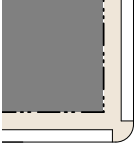
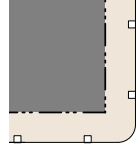
a. Curb. The detailing of the edge of the vehicular pavement, incorporating drainage.			
i. Type	Raised Curb	Raised Curb	Raised Curb
b. Walkway. The pavement dedicated exclusively to pedestrian activity.			
i. Type	Walkway	Walkway	Walkway
ii. Width	6' min.	8' min.	12' min.

Note: Placement of curb ramps shall match the desired path of pedestrian travel. See Marin County Standard Plans for curb ramp design.

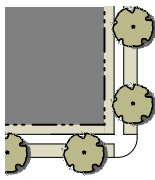
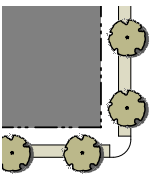
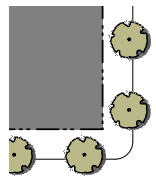
c. Planter. The area that accommodates street trees and other landscaping.			
Arrangement	Regular	Regular	Regular
Types	Planting Strips along curb edge and R.O.W. edge	Planting Strips along curb	Tree Wells (must be located between walkway and curb)
Width	5' min.	5' min.	4' min.

04.070 Privacy Standards

1. **Intent.** These standards are designed to provide privacy between primary living spaces of buildings on each side of a design site line in all T3 and some T4 and T5 zones. Windows and balconies along the side of a building within 20 feet of an interior side design site line in T3EN, T3SN, T4SN.S, T4CN.M, and T5CN zones are subject to these standards.
2. **Standards**
 - A. Primary living spaces adjoining an interior side setback shall either:
 - (1) Orient principal/main windows/glazed openings toward the front and rear of the building, away from interior side lot lines; or
 - (2) Set the window/glazing openings:
 - (a) Perpendicular to interior side lot lines; or
 - (b) More than six feet from interior side lot lines
 - B. Windows and balconies openings within 6 feet of an interior side lot line shall either:
 - (1) Have a minimum sill height of 44 inches; or
 - (2) Place the window at an angle of at least 30 degrees, measured perpendicular to the adjacent side lot line.

Figure 04.070.1: Sill Height Standards along Interior Lot Line

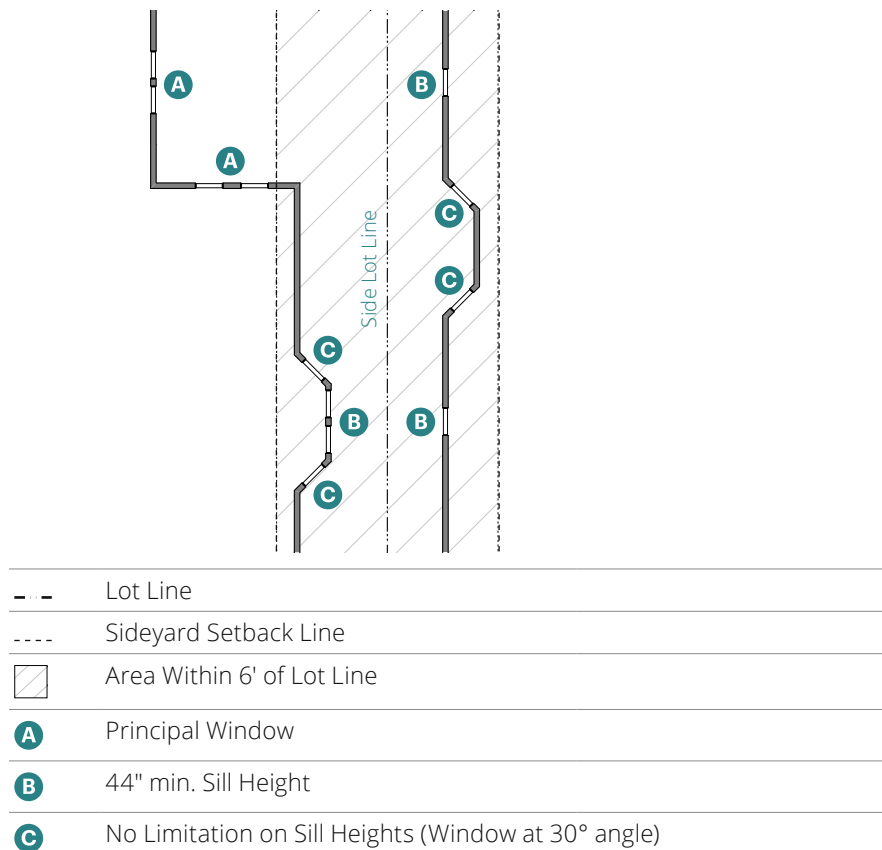

04.080 Environmental Protection Standards

Development based on the standards in this FBC shall not take place in the following locations:

1. Either prime farmland or farmland of statewide importance, as defined pursuant to United States Department of Agriculture land inventory and monitoring criteria, as modified for California, and designated on the maps prepared by the Farmland Mapping and Monitoring Program of the Department of Conservation, or land zoned or designated for agricultural protection or preservation by a local ballot measure that was approved by the voters of that jurisdiction.
2. Wetlands, as defined in the United States Fish and Wildlife Service Manual, Part 660 FW 2 (June 21, 1993).
3. Stream Conservation Areas or Wetland Conservation Areas, as defined in Marin County Code Title 22 (Development Code).
4. Within a very high fire hazard severity zone, as determined by the Department of Forestry and Fire Protection pursuant to Section 51178, or within a high or very high fire hazard severity zone as indicated on maps adopted by the Department of Forestry and Fire Protection pursuant to Section 4202 of the Public Resources Code. This subparagraph does not apply to sites excluded from the specified hazard zones by a local agency, pursuant to subdivision (b) of Section 51179, or sites that have adopted fire hazard mitigation measures pursuant to existing building standards or state fire mitigation measures applicable to the development.
5. A hazardous waste site that is listed pursuant to Section 65962.5 or a hazardous waste site designated by the Department of Toxic Substances Control pursuant to Section 25356 of the Health and Safety Code, unless either of the following apply:
 - A. The site is an underground storage tank site that received a uniform closure letter issued pursuant to subdivision (g) of Section 25296.10 of the Health and Safety Code based on closure criteria established by the State Water Resources Control Board for residential use or residential mixed uses (this section does not alter or change the conditions to remove a site from the list of hazardous waste sites listed pursuant to Section 65962.5); or
 - B. The State Department of Public Health, State Water Resources Control Board, Department of Toxic Substances Control, or a local agency making a determination pursuant to subdivision (c) of Section 25296.10 of the Health and Safety Code, has otherwise determined that the site is suitable for residential use or residential mixed uses.
6. Within a delineated earthquake fault zone as determined by the State Geologist in any official maps published by the State Geologist, unless the development complies with applicable seismic protection building code standards adopted by the California Building Standards Commission under the California Building Standards Law (Part 2.5 (commencing with Section 18901) of Division 13 of the Health and Safety Code), and by any local building department under Chapter 12.2 (commencing with Section 8875) of Division 1 of Title 2.
7. Within a flood plain as determined by maps promulgated by the Federal Emergency Management Agency, unless the development has been issued a flood plain development permit pursuant to Part 59 (commencing with Section 59.1) and Part 60 (commencing with Section 60.1) of Subchapter B of Chapter I of Title 44 of the Code of Federal Regulations.

8. Within a floodway as determined by maps promulgated by the Federal Emergency Management Agency, unless the development has received a no-rise certification in accordance with Section 60.3(d)(3) of Title 44 of the Code of Federal Regulations.
9. Lands identified for conservation in an adopted natural community conservation plan pursuant to the Natural Community Conservation Planning Act (Chapter 10 (commencing with Section 2800) of Division 3 of the Fish and Game Code), habitat conservation plan pursuant to the federal Endangered Species Act of 1973 (16 U.S.C. Sec. 1531 et seq.), or other adopted natural resource protection plan.
10. Habitat for protected species identified as candidate, sensitive, or species of special status by state or federal agencies, fully protected species, or species protected by the federal Endangered Species Act of 1973 (16 U.S.C. Sec. 1531 et seq.), the California Endangered Species Act (Chapter 1.5 (commencing with Section 2050) of Division 3 of the Fish and Game Code), or the Native Plant Protection Act (Chapter 10 (commencing with Section 1900) of Division 2 of the Fish and Game Code).
11. Lands under conservation easement.

This page intentionally left blank

Chapter 5: Specific to Building Types

Sections:

05.010	Purpose
05.020	Building Types
05.030	Overview of Building Types
05.040	Carriage House
05.050	House
05.060	Duplex Side-by-Side
05.070	Duplex Stacked
05.080	Cottage Court
05.090	Fourplex
05.100	Neighborhood Townhouse
05.110	Neighborhood Courtyard
05.120	Pocket Neighborhood
05.130	Multiplex
05.140	Core Townhouse
05.150	Terraced Courtyard Building
05.160	Core Courtyard
05.170	Main Street Building

05.010 Purpose

This Chapter provides the standards for development of individual building types to achieve the intended physical character of each zone, offer housing choices and affordable housing opportunities, and incubate small businesses as amenities within walkable neighborhoods.

05.020 Building Types

1. Building types are used to articulate size, scale, and intensity according to the intent of each zone.
2. Building types are categorized into two groups: House-Scale Buildings and Block-Scale Buildings. See Figure 1 (Example of House-Scale and Block-Scale Buildings) for examples.
 - A. **House-Scale Buildings.** Buildings that are the size of a house, typically ranging in footprint from as small as 25 feet up to 80 feet in any direction; and
 - B. **Block-Scale Buildings.** Buildings that are individually as large as most or all of a block or, when arranged together along a street, appear as long as most or all of a block.

3. Each design site shall have only one primary building type, except as follows, and in compliance with all standards:
 - A. Where allowed by the zone, one Carriage House (Section 05.040) is allowed in addition to the primary building type;
 - B. The Cottage Court (Section 05.080) may consist of up to nine individual buildings;
 - C. The Pocket Neighborhood (Section 05.120) may consist of up to 16 individual buildings.
 - D. The Core Courtyard (Section 05.150) may consist of up to two buildings; and
 - E. More than one building type is required on a parcel that is wider than the minimum design site width of the building type selected by the applicant. See Figure 2 (Example of Multiple Design Sites on One Parcel).
 - (1) Examples:
 - (a) A parcel large enough to accommodate multiple design sites but smaller than the size of a block; or
 - (b) A parcel large enough to create one or more new blocks.
4. On-site open space. The standards identify only the required type (private or common) and amount. For example, if the type only has standards for private open space, common open space is not required for that building type. The identified amount is for the entire building unless specified otherwise.
5. Parking may be designed as tuck-under, detached garage(s), podium or subterranean, in compliance with the zone standards for parking placement.
6. Wings are required to be smaller in size and height than the main body to visually reduce the overall size of a building. To further this objective, the standards specify the amount that wings are required to be offset from the main body so that their facades are not aligned. Wings may be the same number of stories and height as the main body when a density bonus is applied to the building.
7. The maximum number of units identified for each building type is dependent on the design site being large enough to accommodate the zone's standards (e.g., parking).
8. Individual designs may vary from the diagrams for each building type in compliance with the standards of this Chapter and Chapter 7 (Specific to Architectural Design).
9. New buildings and their improvements are subject to Marin's local standards for Fire Safety and Building Safety.

Figure 05.020.1 Example of House-Scale and Block-Scale Buildings

House-Scale Buildings

Main body only

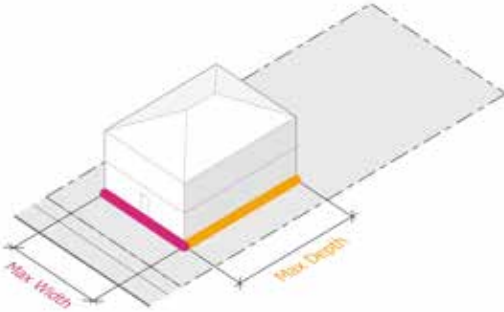

Main body only

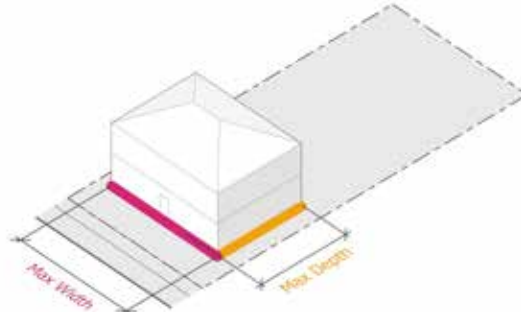

Main body with side and rear wings

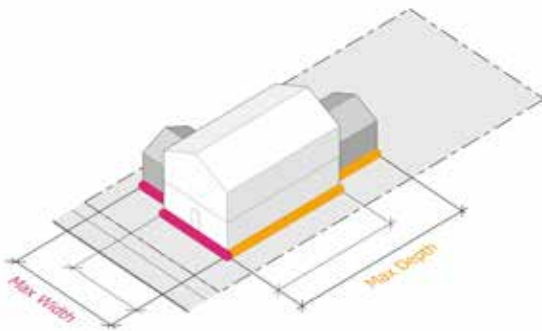

Main body with rear wing

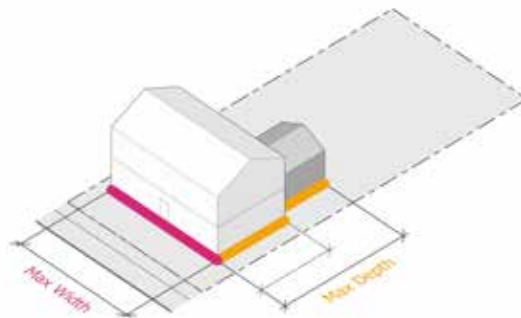

Block-Scale Buildings

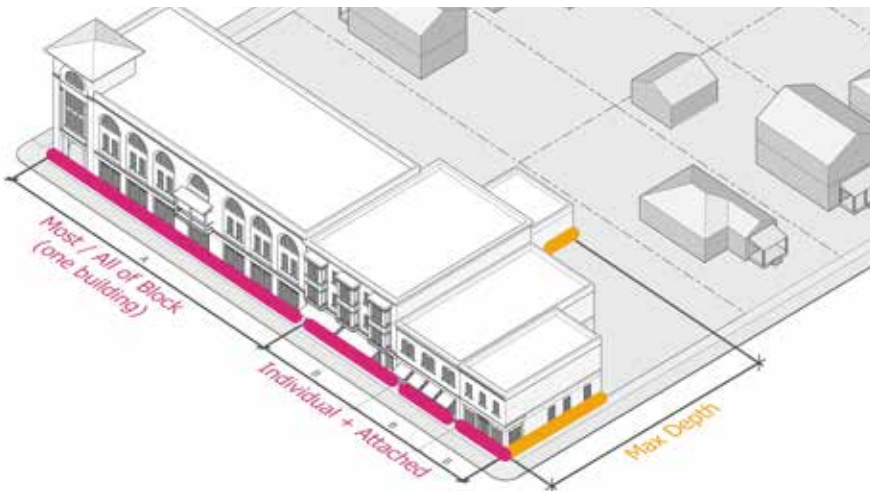
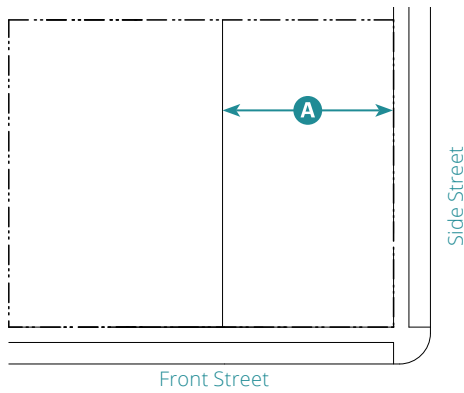
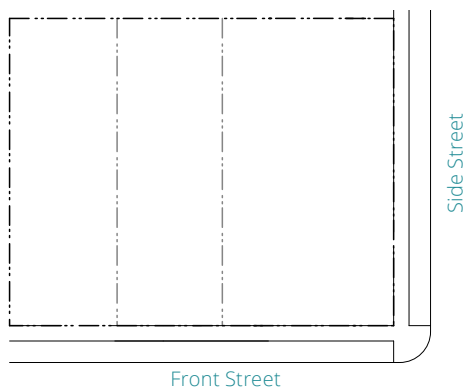

Figure 05.020.2 Example of Multiple Design Sites on One Parcel



Existing parcel wider than the minimum required design site width of the building type selected by the applicant.

A Minimum required design site width of selected building type



One parcel proposed for three design sites. Each design site is sized in compliance with the width and depth standards in Subsection 3 of the zone.

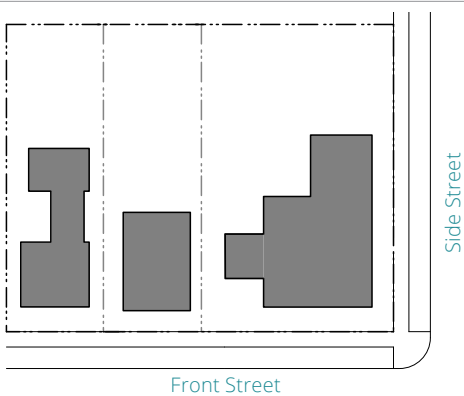

One parcel with three resulting primary buildings in compliance with required setbacks. Individual design sites are not required to be recorded as new parcels.

Larger examples of this approach are parcels that are large enough to make new block(s).

Key

- · - · - Parcel Line
- - - - Design Site Line
- Primary Building Type

05.030 Overview of Building Types

Table A (Building Types Overview) provides an overview of the allowed building types in each zone. The names of the building types are not intended to limit uses within a building type. For example, a Duplex may have non-residential uses within it as allowed by the zone.

Table 05.030.A: Building Types Overview

	Specific Standards	Zones							
		T3		T4				T5	
		EN	SN	SN.S	CN.M	SMS.S	CMS	CN	CMS
House Scale									
Carriage House	05.040	P	P	P	P	P	P	X	X
House	05.050	P	P	P	P	P	X	X	X
Duplex Side-by-Side	05.060	P	P	X	X	X	X	X	X
Duplex Stacked	05.070	X	X	P	X	X	X	X	X
Cottage Court	05.080	X	P	P	X	X	X	X	X
Fourplex	05.090	P	P	P	X	X	X	X	X
Neighborhood Townhouse	05.100	X	P	P	X	P	X	X	X
Neighborhood Courtyard	05.110	X	X	P	P	P	X	X	X
Pocket Neighborhood	05.120	P	P	P	X	X	X	X	X
Multiplex	05.130	X	X	P	P	P	P	P	X
Block Scale									
Core Townhouse	05.140	X	X	X	X	X	P	P	X
Terraced Courtyard Building	05.150	P	P	P	P	X	X	P	X
Core Courtyard	05.160	X	X	X	X	X	P	P	P
Main Street Building	05.170	X	X	X	X	P	P	X	P

Key P = Allowed X = Not Allowed

This page intentionally left blank



Example of Carriage House



Example of Carriage House



Example of Carriage House

1. Description

An accessory structure located at the rear of a design site, above or abutting a detached garage that provides a small residential unit (accessory apartment), home office space, or other small commercial or service use, as allowed by the zone. When used for residential purposes, this housing type is one form of an Accessory Dwelling Unit (ADU).

Synonym: Granny Flat

2. Number of Units

Units per Building	1 max.
Carriage Houses per Design Site	1 max.

Not allowed on the design site of a Cottage Court

General Note: Photos on this page are illustrative, not regulatory.

Alley access required if alley exists

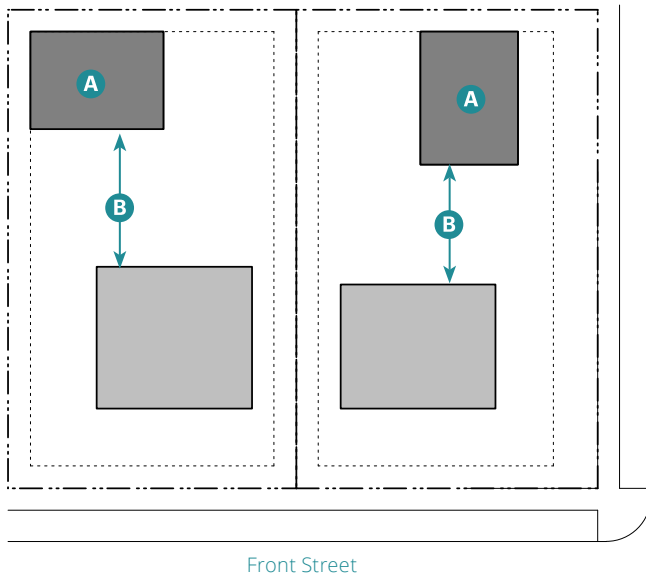

Alley access required if alley exists

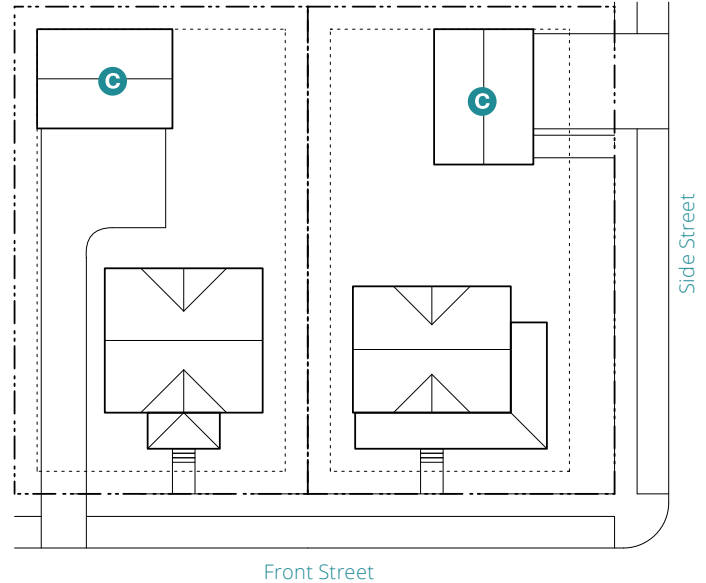

Key

- - - ROW/ Design Site Line
- Building Setback Line
- Carriage House
- Primary Building Type

3. Building Size and Massing

Height

Stories 2.5 max.¹

Main Body²

Area 1,000 sf max. **A**

Depth 24' max.

Separation from Primary Building³ 10' min. **B**

¹ Includes garage story

² In compliance with the setbacks of the zone

³ A Carriage House may be connected to the primary building by an uninhabitable space including, but not limited to, a breezeway.

Key

- - - ROW/ Design Site Line
- Building Setback Line
- Frontage

4. Pedestrian Access

The main entrance shall not be through a garage.

5. Vehicle Access and Parking

Driveway and parking location shall comply with standards in Subsection 7 of the zone. **C**

Parking may be covered, uncovered, or in a garage.

6. Open Space

Private Open Space

Not required

7. Main Body Massing Composition

Select from the allowed massing proportions and apply the standards to the main body width in compliance with Chapter 7 (Specific to Architectural Design) and the following standards.

Front Gable

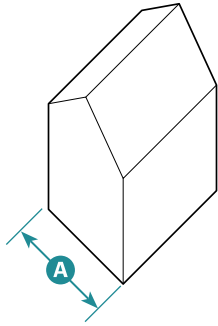

This massing type is a simple rectilinear form that is square or deeper than it is long. The roof is sloped and may be either hipped or gabled.

Main Body

Number of Bays	Flexible ¹	A
Main Body Length	Max. allowed by Subsection 3 of this building type	
Wall Length	40' max.	

Wing(s)

Number of Bays	Not Required
----------------	--------------

This page intentionally left blank



Example of House



Example of House



Example of House

1. Description

A small-to-medium-sized, detached, House-Scale Building with one unit, small-to-medium setbacks, a rear setback, and located within a low-intensity, walkable neighborhood.

2. Number of Units

Units per Building	1 max. ¹
Buildings per Design Site	1 max. ²

¹An additional unit in the form of a JADU allowed in T4CN.M.

²Not including ADU

General Note: Photos on this page are illustrative, not regulatory.

Alley access required if alley exists

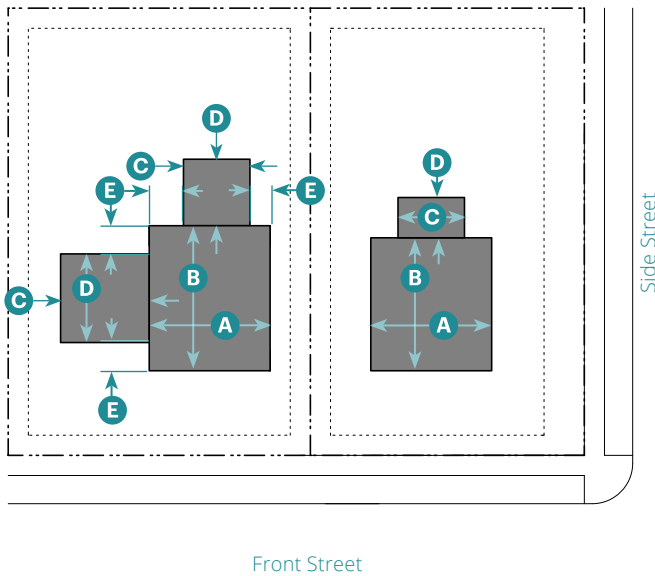

Alley access required if alley exists

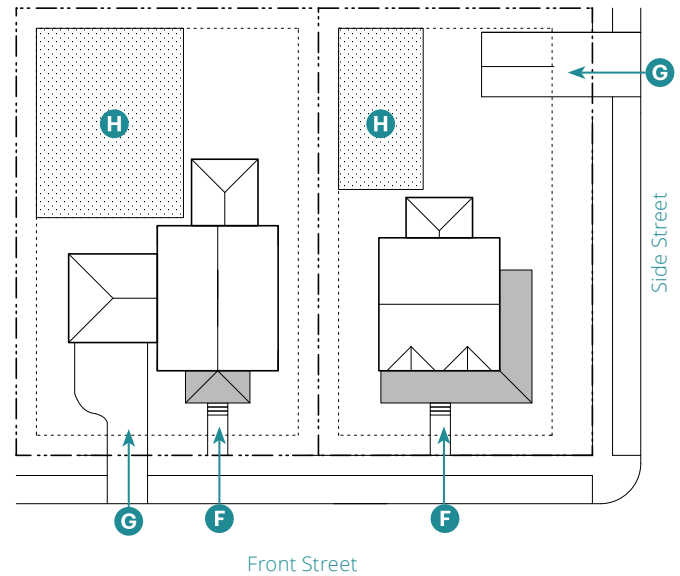

Key

- ROW/ Design Site Line
- Building Setback Line
- Building

3. Building Size and Massing

Height	T3EN	T4CN.M
	T3SN	
	T4SN.S	
	T4SMS.S	
Stories	2.5 max.	3.5 max. ³
Main Body⁴		
Width	— 36' max. —	A
Depth	— 48' max. —	B
Wing(s)^{4,5}		
Width	— 20' max. —	C
Depth	— 20' max. —	D
Separation between Wings	— 15' min. —	
on same facade		
Offset from Main Body	— 5' min. —	E

Facades shall be designed in compliance with Chapter 7 (Specific to Architectural Design).

³ Only if includes JADU (Junior Accessory Dwelling Unit)

⁴ In compliance with Subsection 5 of the zone

⁵ Height is limited to 1 story less than main body and 10' less to highest eave/parapet.

Key

- ROW/ Design Site Line
- Building Setback Line
- Frontage
- ▨ Private Open Space

4. Pedestrian Access

Main Entrance Location Front Street **F**

5. Vehicle Access and Parking

Driveway and parking location shall comply with standards in Subsection 7 of the zone. **G**

Parking may be covered, uncovered, or in a garage.

6. Open Space

Private Open Space

Area 300 sf min. **H**

Required setbacks and driveways do not count toward open space.

Required private open space shall be located behind the main body of the building.

7. Main Body Massing Composition

Select from the allowed massing proportions and apply the standards to the main body width in compliance with Chapter 7 (Specific to Architectural Design) and the following standards.

Front Gable

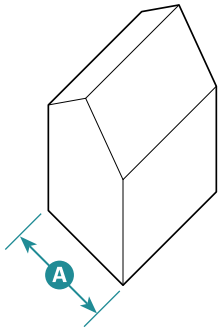

This massing type is a simple rectilinear form that is deeper than it is long. The roof is sloped and may be either hipped or gabled.

Main Body

Number of Bays	3-5 bays ¹	(A)
Main Body Width	Max. allowed by Subsection 3 of this building type	

Wall Length	40' max.
-------------	----------

Wing(s)

Number of Bays	Not Required
----------------	--------------

Side Gable

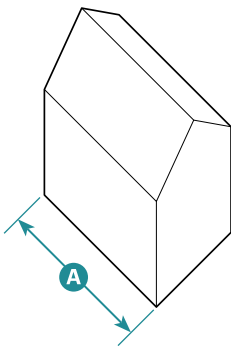

This massing type is a simple rectilinear form that is longer than it is deep. The roof is sloped and may be either hipped or gabled.

Main Body

Number of Bays	3-5 bays ¹	(A)
Main Body Width	Max. allowed by Subsection 3 of this building type	

Wall Length	40' max.
-------------	----------

Wing(s)

Number of Bays	Not Required
----------------	--------------

Gable L (2/3 + 1/3)

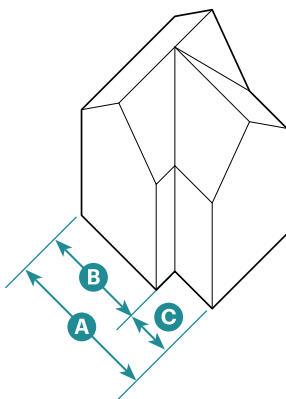

This massing type divides the facade into three equal parts, 1 part projecting and 2/3 projecting towards front property line. The roof is sloped with a gable at the projecting 1/3.

Main Body

Number of Bays	3 bays ¹	(A)
Main Body Width	Max. allowed by Subsection 3 of this building type	

Massing Proportions	2/3	(B)
	1/3	(C)

Wall Length	40' max.
-------------	----------

Wing(s)

Number of Bays	Not Required
----------------	--------------

¹ Required on facades along a street or civic space.

05.060 Duplex Side-by-Side



Example of Duplex Side-by-Side



Example of Duplex Side-by-Side



Example of Duplex Side-by-Side

1. Description

A small-to-medium-sized, detached, House-Scale Building with small-to-medium setbacks and a rear setback. The building consists of two side-by-side units, both facing the street and within a single Building massing. The type has the appearance of a medium-to-large, single-unit house and is scaled to fit within lower-intensity neighborhoods.

2. Number of Units

Units per Building	2 max.
Buildings per Design Site	1 max.

General Note: Photos on this page are illustrative, not regulatory.

Alley access required if alley exists

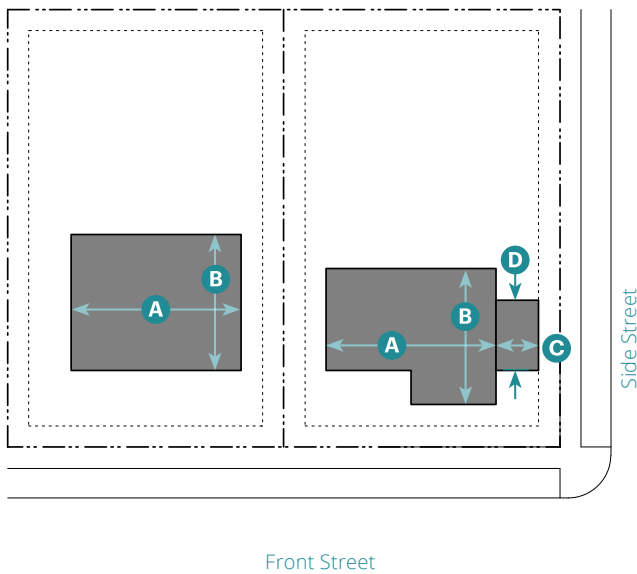

Alley access required if alley exists

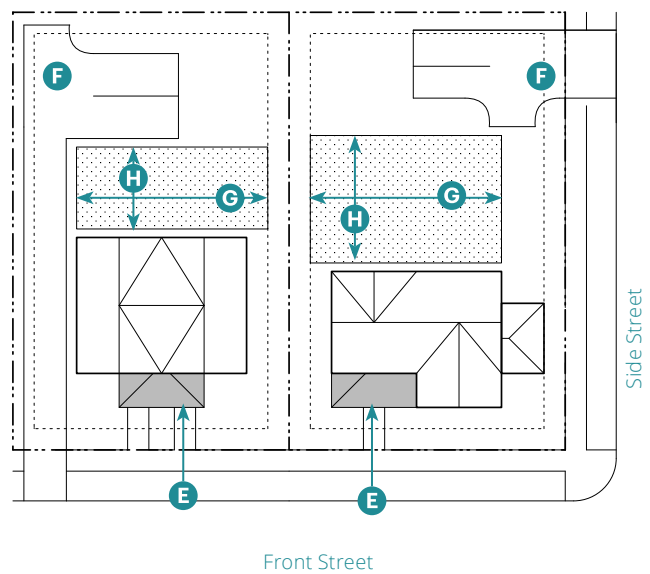

Key

- - - - ROW/ Design Site Line
- - - - Building Setback Line
- Building

3. Building Size and Massing

Height	
Stories	2.5 max.
Main Body ¹	
Width	48' max. (A)
Depth	36' max. (B)
Wing(s) ^{1,2}	
Width	15' max. (C)
Depth	24' max. (D)
Separation between Wings on same facade	15' min.
Offset from Main Body	5' min.

Facades shall be designed in compliance with Chapter 7 (Specific to Architectural Design).

¹ In compliance with Subsection 5 of the zone
² Height is limited to 1 story less than main body and 10' less to highest eave/parapet.

Key

- - - - ROW/ Design Site Line
- - - - Building Setback Line
- Frontage
- Private Open Space

4. Pedestrian Access

Main Entrance Location Front Street³ **(E)**

Each unit shall have an entry facing the street on or within 15' of the front facade.

³ On corner design sites, each unit shall front a different street.

5. Vehicle Access and Parking

Driveway and parking location shall comply with standards in Subsection 7 of the zone. **(F)**

Parking may be covered, uncovered, or in a garage.

6. Open Space

Common Open Space	
Width	15' min. (G)
Depth	15' min. (H)

Required setbacks and driveways do not count toward open space.

Required private open space shall be located behind the main body of the building.

7. Main Body Massing Composition

Select from the allowed massing proportions and apply the standards to the main body width in compliance with Chapter 7 (Specific to Architectural Design) and the following standards.

Side Gable

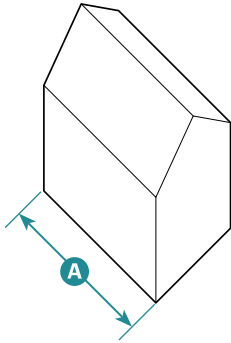

This massing type is a simple rectilinear form that is longer than it is deep. The roof is sloped and may be either hipped or gabled.

Main Body	
Number of Bays	3-6 bays ¹ A
Main Body Width	Max. allowed by Subsection 3 of this building type
Wall Length	40' max.

Wing(s)	
Number of Bays	Not Required

Gable L (2/3 + 1/3)

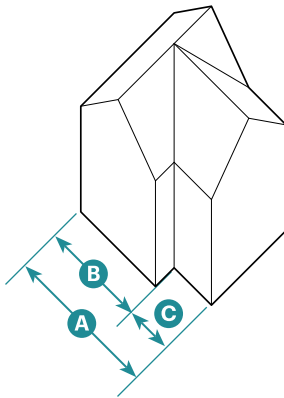

This massing type divides the facade into three equal parts, 1 part projecting and 2/3 projecting towards front property line. The roof is sloped with a gable at the projecting 1/3.

Main Body	
Number of Bays	3-6 bays ¹ A
Main Body Width	Max. allowed by Subsection 3 of this building type
Massing Proportions	2/3 B
	1/3 C
Wall Length	40' max.

Wing(s)	
Number of Bays	Not Required

Gable L (2/5 + 3/5)

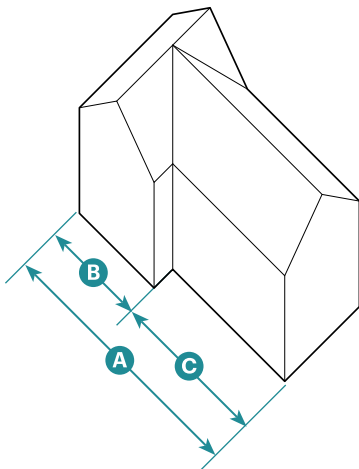

This massing type divides the facade into five equal parts, with two parts projecting and three parts set back to create a shallow forecourt. The roof is sloped with gables at the projecting two parts.

Main Body	
Number of Bays	3-6 bays ¹ A
Main Body Width	Max. allowed by Subsection 3 of this building type
Massing Proportions	2/5 B
	3/5 C
Wall Length	40' max.

Wing(s)	
Number of Bays	Not Required

7. Main Body Massing Composition (Continued)

Twin Gable

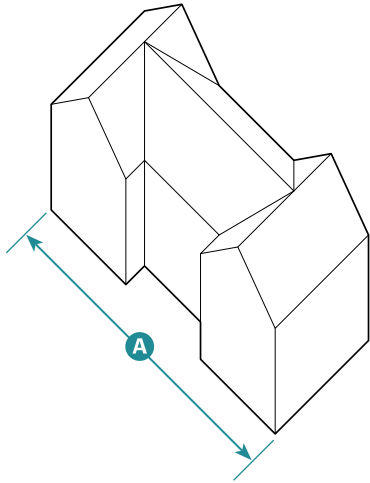

This massing type divides the facade into three parts, with the middle part set back slightly to create a shallow open space. The roof is sloped and may be either hipped or gabled.

Main Body	
Number of Bays	3-6 bays ¹ A
Main Body Width	Max. allowed by Subsection 3 of this building type
Wall Length	40' max.
Wing(s)	
Number of Bays	Not Required

¹Required on facades along a street or civic space.

This page intentionally left blank



Example of Duplex Stacked



Example of Duplex Stacked



Example of Duplex Stacked

1. Description

A small-to-medium-sized, detached, House-Scale Building with small-to-medium setbacks and a rear setback. The building consists of two stacked units, both facing the street and within a single building massing. The type has the appearance of a medium-to-large, single-unit house and is scaled to fit within lower-intensity neighborhoods.

2. Number of Units

Units per Building	2 max.
Buildings per Design Site	1 max.

General Note: Photos on this page are illustrative, not regulatory.

Alley access required if alley exists

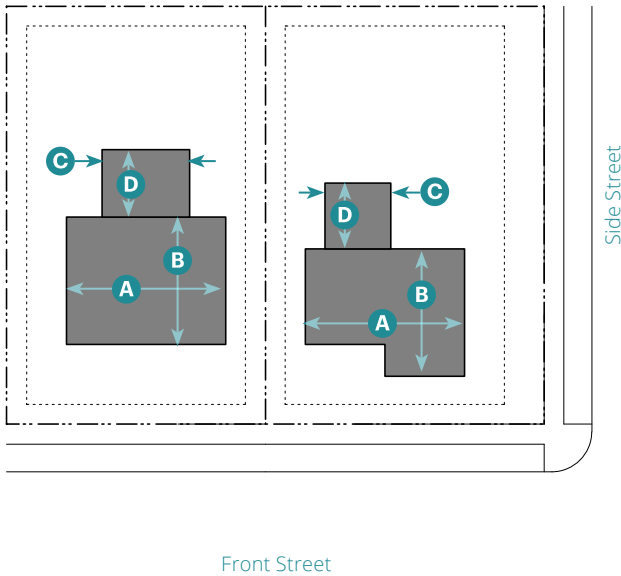

Alley access required if alley exists

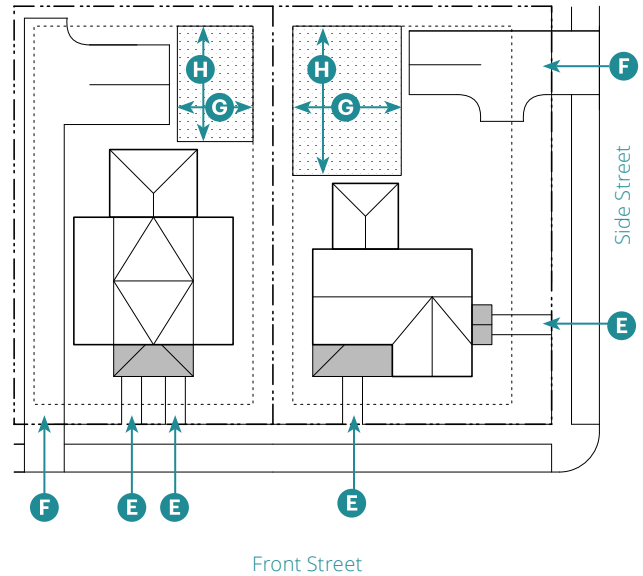

Key

- - - - ROW/ Design Site Line
- Building Setback Line
- Building

3. Building Size and Massing

Height	
Stories	2.5 max.
Main Body ¹	
Width	36' max. A
Depth	48' max. B
Wing(s) ^{1,2}	
Width	15' max. C
Depth	24' max. D
Separation between Wings on same facade	15' min.
Offset from Main Body	5' min.

Facades shall be designed in compliance with Chapter 7 (Specific to Architectural Design).

¹ In compliance with Subsection 5 of the zone
² Height is limited to 1 story less than main body and 10' less to highest eave/parapet.

Key

- - - - ROW/ Design Site Line
- Building Setback Line
- Frontage
- ▨ Private Open Space

4. Pedestrian Access

Main Entrance Location Front Street³ **E**
 Each unit shall have an entry facing the street on or within 15' of the front facade.

³ On corner design sites, each unit shall front a different street.

5. Vehicle Access and Parking

Driveway and parking location shall comply with standards in Subsection 7 of the zone. **F**
 Parking may be covered, uncovered, or in a garage.

6. Open Space

Private Open Space	
Width	15' min. G
Depth	15' min. H

Required setbacks and driveways do not count toward open space.

Required private open space shall be located behind the main body of the building.

7. Main Body Massing Composition

Select from the allowed massing proportions and apply the standards to the main body width in compliance with Chapter 7 (Specific to Architectural Design) and the following standards.

Front Gable

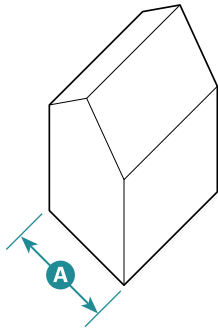

This massing type is a simple rectilinear form that is deeper than it is long. The roof is sloped and may be either hipped or gabled.

Main Body

Number of Bays	2-3 bays ¹	A
Main Body Width	Max. allowed by Subsection 3 of this building type	

Wall Length	40' max.
-------------	----------

Wing(s)

Number of Bays	Not Required
----------------	--------------

Side Gable

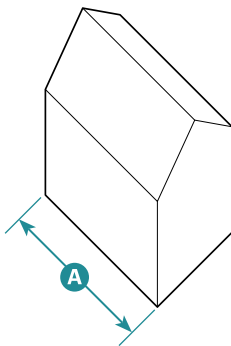

This massing type is a simple rectilinear form that is longer than it is deep. The roof is sloped and may be either hipped or gabled.

Main Body

Number of Bays	3-5 bays ¹	A
Main Body Width	Max. allowed by Subsection 3 of this building type	

Wall Length	40' max.
-------------	----------

Wing(s)

Number of Bays	Not Required
----------------	--------------

Gable L (2/3 + 1/3)

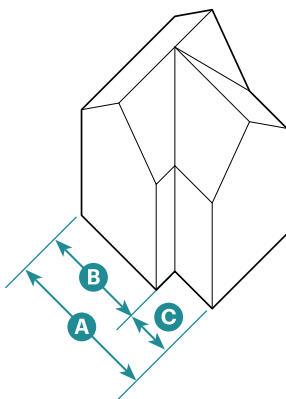

This massing type divides the facade into three equal parts, 1 part projecting and 2/3 projecting towards front property line. The roof is sloped with a gable at the projecting 1/3.

Main Body

Number of Bays	2-3 bays ¹	A
Main Body Width	Max. allowed by Subsection 3 of this building type	

Massing Proportions	2/3	B
	1/3	C

Wall Length	40' max.
-------------	----------

Wing(s)

Number of Bays	Not Required
----------------	--------------

¹ Required on facades along a street or civic space.

This page intentionally left blank



Example of Cottage Court



Example of Cottage Court



Example of Cottage Court

1. Description

A group of up to nine small, detached, House-Scale Buildings arranged to define a shared court open to and visible from the street. The shared court is common open space and takes the place of a private rear setback, thus becoming an important community-enhancing element. The type is scaled to fit within low-to-moderate-intensity neighborhoods and in non-residential contexts.

Synonym: Bungalow Court

2. Number of Units

Units per Building	1 max.
Buildings per Design Site	3 min.; 9 max. ¹

¹ In the T3SN and T4SN.S zones, the rearmost Cottage may contain up to 2 units, for a total of 10 units.

General Note: Photos on this page are illustrative, not regulatory.

Alley access required if alley exists

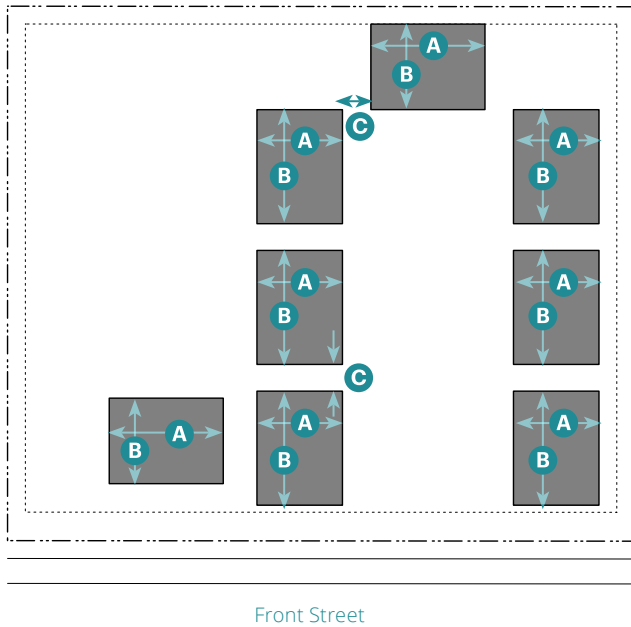

Alley access required if alley exists

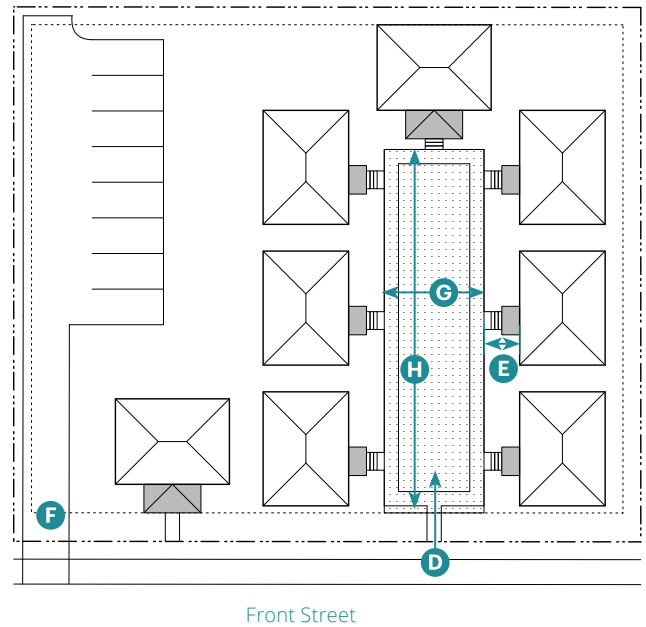

Key

- - - ROW/ Design Site Line ■ Building
- Building Setback Line

3. Building Size and Massing

Height

Stories	1.5 max.
To Highest Eave/parapet	18' max.

Main Body²

Width	32' max.	(A)
Depth	32' max.	(B)
Separation between Cottages	7' min.	(C)

Wing(s)

Not Allowed

4. Pedestrian Access

Shared court shall be accessible from front street. **(D)**

Pedestrian Path Setbacks

From Building Entrance 6' min. **(E)**

Main entrance to units required from shared court.

Units on a corner may enter from the side street.

Pedestrian connections shall connect all buildings to the public ROW, shared court, and parking areas.

Facades shall be designed in compliance with Chapter 7 (Specific to Architectural Design).

² In compliance with Subsection 5 of the zone

Key

- - - ROW/ Design Site Line ■ Frontage
- Building Setback Line □ Common Open Space

5. Vehicle Access and Parking

Driveway and parking location shall comply with standards in Subsection 7 of the zone. **(F)**

Parking may be covered, uncovered, or in a garage.

Parking spaces shall be grouped in one or more parking area(s) at rear or side of design site.

6. Open Space

Common Open Space

Width	20' min. clear	(G)
Depth	75' min. (3-4 units)	(H)
	90' min. (5-9 units)	

Required setbacks and driveways do not count as open space.

Up to 1/3 of the shared court(s) may be used for stormwater management if designed as a rain garden or bioswale.

7. Miscellaneous

Fencing

Fencing only allowed around or between individual buildings and shall not exceed 36" in height.

Visibility shall be maintained through the fencing.

7. Main Body Massing Composition

Select from the allowed massing proportions and apply the standards to the main body width in compliance with Chapter 7 (Specific to Architectural Design) and the following standards.

Front Gable

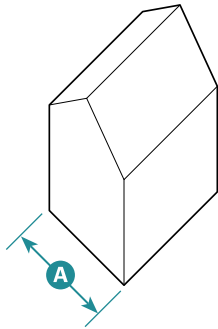

This massing type is a simple rectilinear form that is deeper than it is long. The roof is sloped and may be either hipped or gabled.

Main Body

Number of Bays	2-3 bays ¹	A
Main Body Width	Max. allowed by Subsection 3 of this building type	

Wall Length	40' max.
-------------	----------

Wing(s)

Number of Bays	Not Required
----------------	--------------

Gable L (2/3 + 1/3)

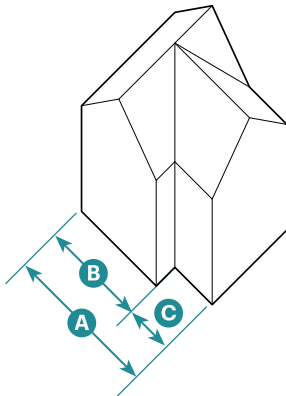

This massing type divides the facade into three equal parts, 1 part projecting and 2/3 projecting towards front property line. The roof is sloped with a gable at the projecting 1/3.

Main Body

Number of Bays	2-3 bays ¹	A
Main Body Width	Max. allowed by Subsection 3 of this building type	

Massing Proportions	2/3	B
	1/3	C

Wall Length	40' max.
-------------	----------

Wing(s)

Number of Bays	Not Required
----------------	--------------

¹ Required on facades along a street, open space, or civic space.

05.090 Fourplex



Example of Fourplex



Example of Fourplex



Example of Fourplex

1. Description

A small-to-medium-sized, detached, House-Scale Building that consists of three to four side-by-side and/or stacked units, typically with one shared entry or individual entries along the front. The type has the appearance of a medium-sized, single-unit house and is scaled to fit within low- to moderate-intensity neighborhoods.

2. Number of Units

Units per Building	3 min.; 4 max.
Buildings per Design Site	1 max.

General Note: Photos on this page are illustrative, not regulatory.

Alley access required if alley exists

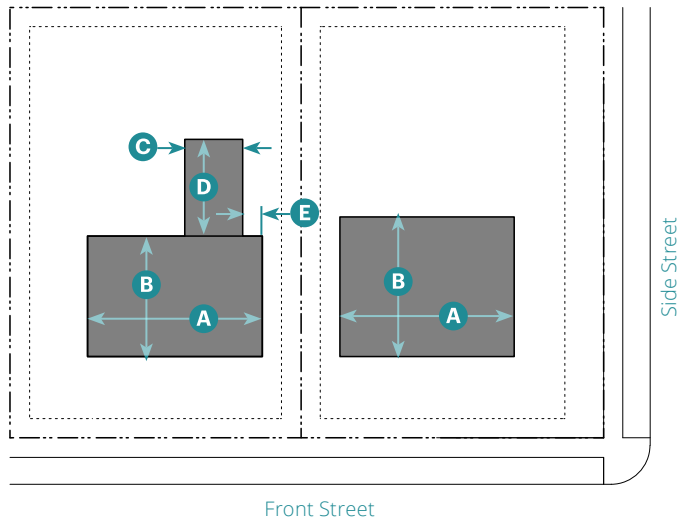

Alley access required if alley exists

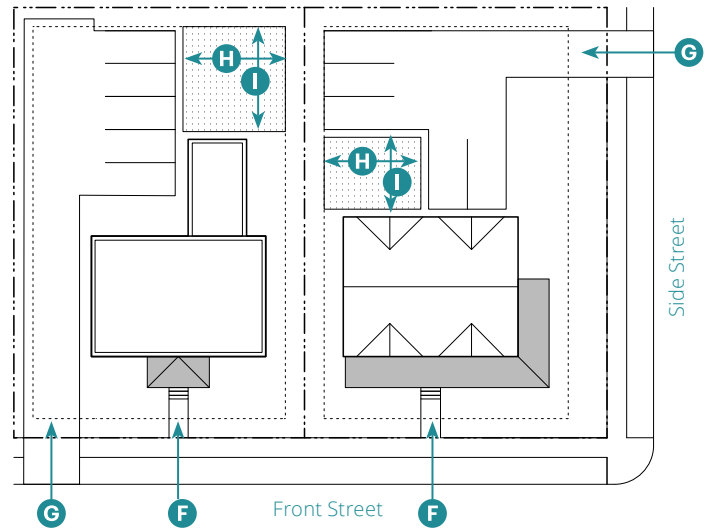

Key

- - - ROW/ Design Site Line
- - - - Building Setback Line
- Building

3. Building Size and Massing

Height

Stories 2.5 max.

Main Body¹

Width 48' max. **A**

Depth 48' max. **B**

Wing(s)^{1,2}

Width 15' max. **C**

Depth 20' max. **D**

Separation between Wings on same facade 15' min.

Offset from Main Body 5' min. **E**

Facades shall be designed in compliance with Chapter 7 (Specific to Architectural Design).

¹In compliance with Subsection 5 of the zone

²Height is limited to 1 story less than main body and 10' less to highest eave/parapet.

Key

- - - ROW/ Design Site Line
- - - - Building Setback Line
- Frontage
- Common Open Space

4. Pedestrian Access

Main Entrance Location Front Street **F**

Each unit may have an individual entry.

5. Vehicle Access and Parking

Driveway and parking location shall comply with standards in Subsection 7 of the zone. **G**

Parking may be covered, uncovered, or in a garage.

6. Open Space

Common Open Space³

Width 15' min. **H**

Depth 15' min. **I**

Required setbacks and driveways do not count toward open space.

Required common open space shall be located behind the main body of the building.

³None is required if the building is within 800' of public open space

7. Main Body Massing Composition

Select from the allowed massing proportions and apply the standards to the main body width in compliance with Chapter 7 (Specific to Architectural Design) and the following standards.

Front Gable

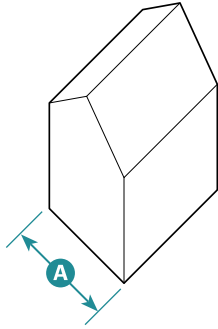

This massing type is a simple rectilinear form that is deeper than it is long. The roof is sloped and may be either hipped or gabled.

Main Body	
Number of Bays	Flexible ¹ A
Main Body Width	Max. allowed by Subsection 3 of this building type
Wall Length	40' max.
Wing(s)	
Number of Bays	Not Required

Side Gable

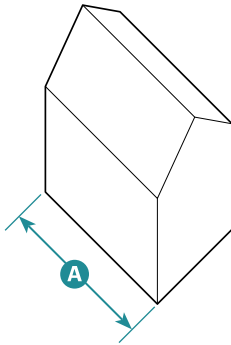

This massing type is a simple rectilinear form that is longer than it is deep. The roof is sloped and may be either hipped or gabled.

Main Body	
Number of Bays	Flexible ¹ A
Main Body Width	Max. allowed by Subsection 3 of this building type
Wall Length	40' max.
Wing(s)	
Number of Bays	Not Required

Gable L (2/3 + 1/3)

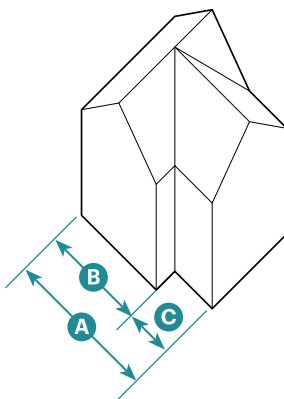

This massing type divides the facade into three equal parts, 1 part projecting and 2/3 projecting towards front property line. The roof is sloped with a gable at the projecting 1/3.

Main Body	
Number of Bays	3 bays ¹ A
Main Body Width	Max. allowed by Subsection 3 of this building type
Massing Proportions	2/3 B
	1/3 C
Wall Length	40' max.
Wing(s)	
Number of Bays	Not Required

7. Main Body Massing Composition (Continued)

Gable L (2/5 + 3/5)

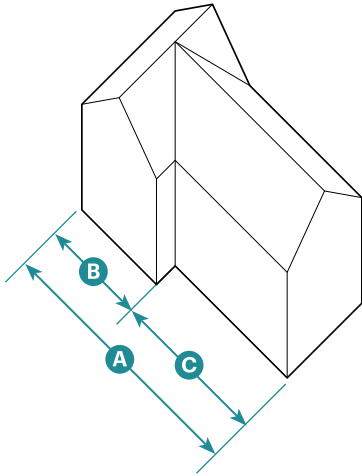

This massing type divides the facade into five equal parts, with two parts projecting and three parts set back to create a shallow forecourt. The roof is sloped with gables at the projecting two parts.

Main Body	
Number of Bays	3-6 bays ¹ A
Main Body Width	Max. allowed by Subsection 3 of this building type
Massing Proportions	2/5 B
	3/5 C
Wall Length	40' max.

Wing(s)	
Number of Bays	Not Required

Twin Gable

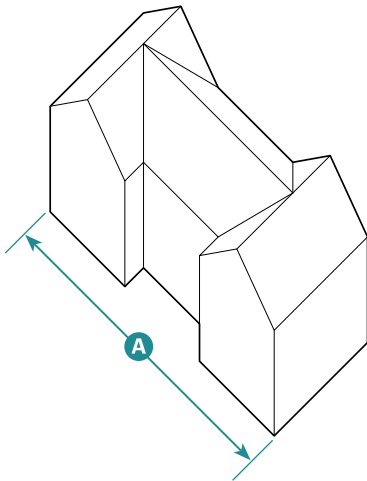

This massing type divides the facade into three parts, with the middle part set back slightly to create a shallow open space. The roof is sloped and may be either hipped or gabled.

Main Body	
Number of Bays	3-6 bays ¹ A
Main Body Width	Max. allowed by Subsection 3 of this building type
Wall Length	40' max.

Wing(s)	
Number of Bays	Not Required

¹ Required on facades along a street or civic space.

This page intentionally left blank

05.100 Neighborhood Townhouse



Example of Neighborhood Townhouse



Example of Neighborhood Townhouse



Example of Neighborhood Townhouse

1. Description

A small-sized, typically attached, House-Scale Building (up to four units side-by-side) with a rear setback. Each Neighborhood Townhouse consists of one unit. As allowed by the zone, the type may also be detached with minimal separations between buildings. The type is typically located within low-to-moderate-intensity neighborhoods.

Synonym: Rowhouse

2. Number of Units

Units per Building	1 max.
Buildings per Design Site	1 max.
Buildings per Run	5 max.

General Note: Photos on this page are illustrative, not regulatory.

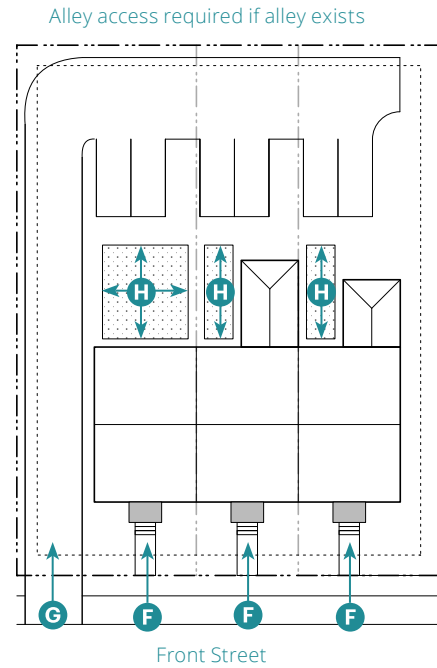
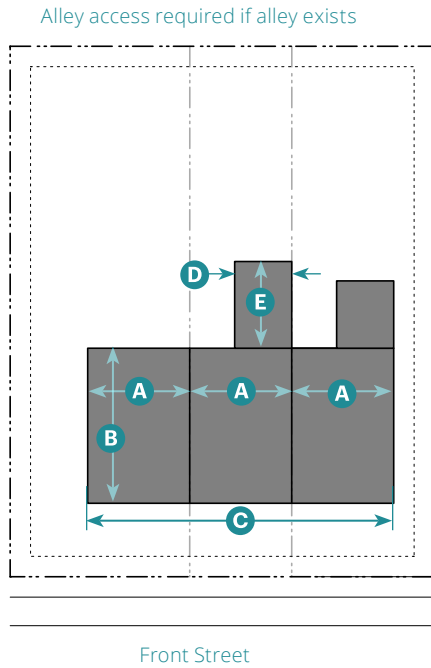

Key

- - - ROW/ Design Site Line
- Building Setback Line
- Building

3. Building Size and Massing

Height	T3SN	T4SN.S T4SMS.S
--------	------	-------------------

Stories — 2.5 max. —

Main Body¹

Width per Unit 24' min. 18' min. **A**

Depth per Unit — 40' max. — **B**

Width per Run 100' max. 120' max. **C**

Wing(s)^{1,2}

Width — 14' max. — **D**

Depth — 25' max. — **E**

Separation between Wings on same facade — 10' min. —

Facades shall be designed in compliance with Chapter 7 (Specific to Architectural Design).

¹ In compliance with Subsection 5 of the zone

² Height is limited to 1 story less than main body and 10' less to highest eave/parapet.

Key

- - - ROW/ Design Site Line
- Building Setback Line
- Frontage
- ▨ Private Open Space

4. Pedestrian Access

Main Entrance Location Front Street **F**

Each unit shall have an individual entry facing a street.

5. Vehicle Access and Parking

Driveway and parking location shall comply with standards in Subsection 7 of the zone. **G**

Parking may be covered, uncovered, or in a garage.

6. Open Space

Private Open Space

Width 8' min. **H**

Depth 8' min. **H**

Required setbacks and driveways do not count toward open space.

Required private open space shall be located behind the main body of the building.

7. Main Body Massing Composition

Select from the allowed massing proportions and apply the standards to the main body width in compliance with Chapter 7 (Specific to Architectural Design) and the following standards.

Side Gable

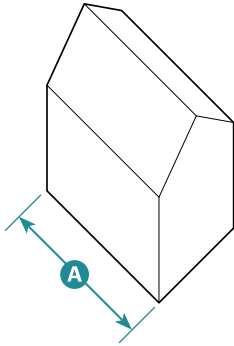

This massing type is a simple rectilinear form that is longer than it is deep. The roof is sloped and may be either hipped or gabled.

Main Body

Number of Bays	Flexible ¹	A
Main Body Width	Max. allowed by Subsection 3 of this building type	

Wall Length	40' max.
-------------	----------

Wing(s)

Number of Bays	Not Required
----------------	--------------

Twin Gable

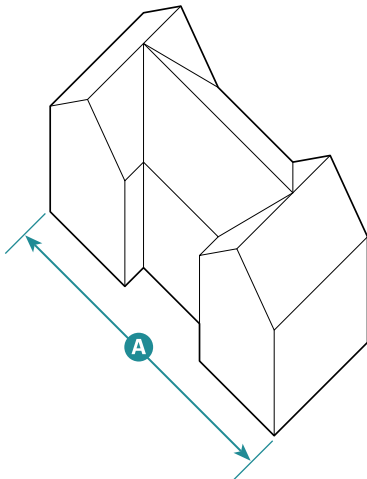

This massing type divides the facade into three parts, with the middle part set back slightly to create a shallow open space. The roof is sloped and may be either hipped or gabled.

Main Body

Number of Bays	3-4 bays ¹	A
Main Body Width	Max. allowed by Subsection 3 of this building type	

Wall Length	40' max.
-------------	----------

Wing(s)

Number of Bays	Not Required
----------------	--------------

Center Gable (1/3 + 1/3 + 1/3)

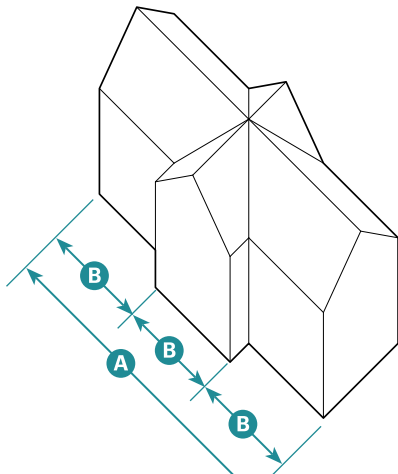

This massing type divides the facade into three equal parts, with the middle third projecting. The roof is sloped and may be either hipped or gabled.

Main Body

Number of Bays	3-6 bays ¹	A
Main Body Width	Max. allowed by Subsection 3 of this building type	

Massing Proportions	1/3 each	B
---------------------	----------	---

Wall Length	40' max.
-------------	----------

Wing(s)

Number of Bays	Not Required
----------------	--------------

¹ Required on facades along a street or civic space.

This page intentionally left blank

05.110 Neighborhood Courtyard



Example of Neighborhood Courtyard



Example of Neighborhood Courtyard



Example of Neighborhood Courtyard

1. Description

A detached, House-Scale Building in an L-, U-, or O-shaped that consists of up to 16 multiple attached and/or stacked units, accessed from a shared courtyard. The shared court is common open space and takes the place of a rear setback. The type is typically integrated as a small portion of lower-intensity neighborhoods or more consistently into moderate-intensity neighborhoods.

Synonym: Courtyard Apartment

2. Number of Units

	T4SN.S	T4CN.M	T4SMS.S
Units per Building	12 max.	16 max.	16 max.
Buildings per Design Site	—————2 max.—————		

General Note: Photos on this page are illustrative, not regulatory.

Alley access required if alley exists

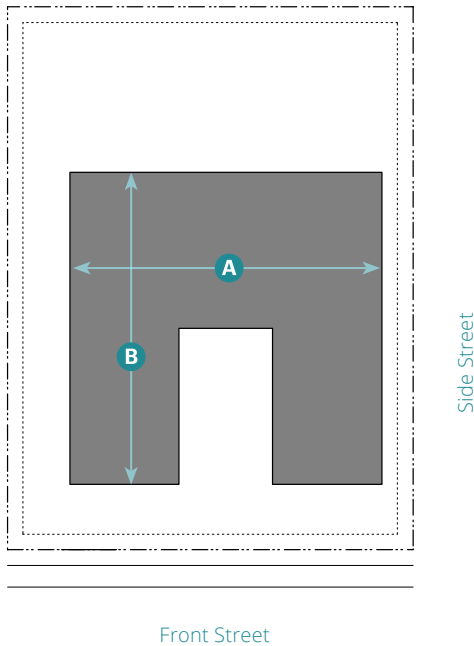

Alley access required if alley exists

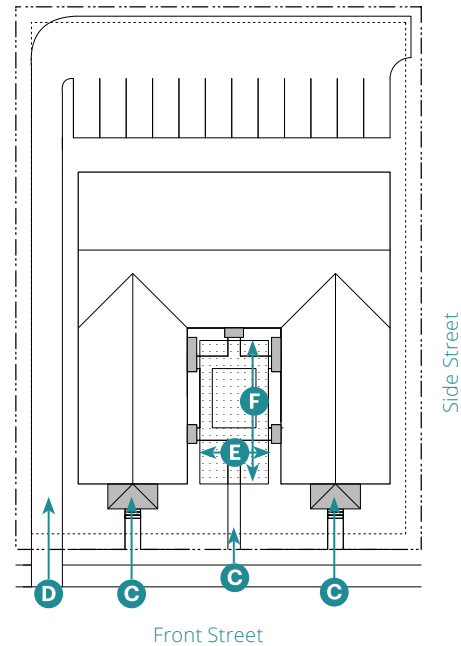

Key

- - - - ROW/ Design Site Line
- Building Setback Line
- Building

3. Building Size and Massing

Height	T4SN.S	T4CN.M	T4SMS.S
Stories	2.5 max.	3.5 max.	2.5 max.

Main Body^{1, 2}

Width	_____100' max._____	A
Depth	_____100' max._____	B

Wing(s)

Not Allowed

Facades shall be designed in compliance with Chapter 7 (Specific to Architectural Design).

If building is designed as two separate buildings, the separation area(s) shall be designed as a courtyard

¹ In compliance with Subsection 5 of the zone

² This type may be designed as two adjacent buildings, not more than 30' apart, in compliance with the standards of this Subsection.

Key

- - - - ROW/ Design Site Line
- Building Setback Line
- Frontage
- Common Open Space

4. Pedestrian Access

Main Entrance Location² Courtyard or Street **C**

² The main entry of ground floor units shall be directly off of a courtyard or street, whichever is closer.

5. Vehicle Access and Parking

Driveway and parking location shall comply with standards in Subsection 7 of the zone. **D**

Parking may be covered, uncovered, or in a garage.

6. Open Space

Common Open Space	L-shaped	U-, O-shaped
Width	20' min.	25' min. E
Depth	30' min.	60' min. F

Courtyard(s) shall be accessible from the front street.

Multiple courtyards are required to be connected via a Passage through or between buildings.

Building shall define at least three walls of the courtyard.

Up to 1/3 of the shared court(s) may be used for stormwater management if designed as a rain garden or bioswale.

Front of courtyard not defined by building shall be defined by 2'-6" to 5' tall wall with entry gate/door.

7. Main Body Massing Composition

Select from the allowed massing proportions and apply the standards to the main body width in compliance with Chapter 7 (Specific to Architectural Design) and the following standards.

Gabled Courtyard

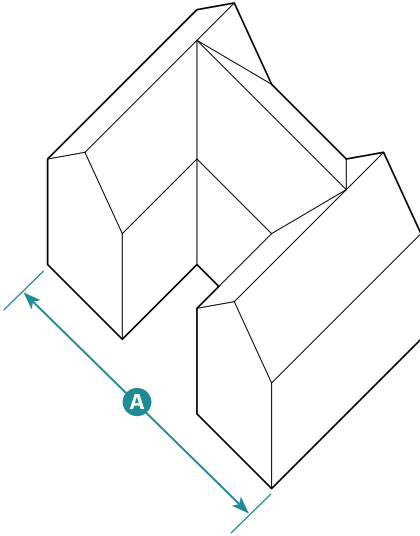

This massing type divides the facade into three parts, with the middle part set back substantially to create a deep open space. The roof is sloped and may be either hipped or gabled.

Main Body	
Number of Bays	6-9 bays ¹ A
Main Body Width	Max. allowed by Subsection 3 of this building type
Wall Length	40' max.

Wing(s)	
Number of Bays	Not Required

Gabled L Courtyard

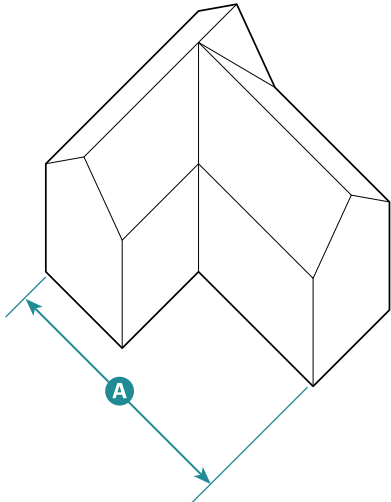

This massing type divides the facade into two parts, with one part set back substantially to create a deep open space. The roof is sloped and may be either hipped or gabled.

Main Body	
Number of Bays	4-6 bays ¹ A
Main Body Width	Max. allowed by Subsection 3 of this building type
Wall Length	40' max.

Wing(s)	
Number of Bays	Not Required

¹ Required on facades along a street or civic space.

This page intentionally left blank



Source: Starr Hill Vision Plan

Example of Pocket Neighborhood



Source: Ross Chapin

Example of Pocket Neighborhood



Source: Ross Chapin

Example of Pocket Neighborhood

1. Description

A group of 5 to 16 detached, House-Scale Buildings each containing one to two units, arranged to define a shared open space. The shared open space is common open space and takes the place of a private rear setback, trees become an important community-enhancing element. The type is scaled to fit within low-to-moderate intensity neighborhoods.

2. Number of Units

	T3EN	T3SN	T4SN.S
Units per Building			
<25% slopes	2 max.	2 max.	2 max.
>25% slopes	1 max.	1 max.	1 max.
Buildings per Design Site	5 min; 10 max	5 min; 16 max	5 min; 16 max

General Note: Photos on this page are illustrative, not regulatory.

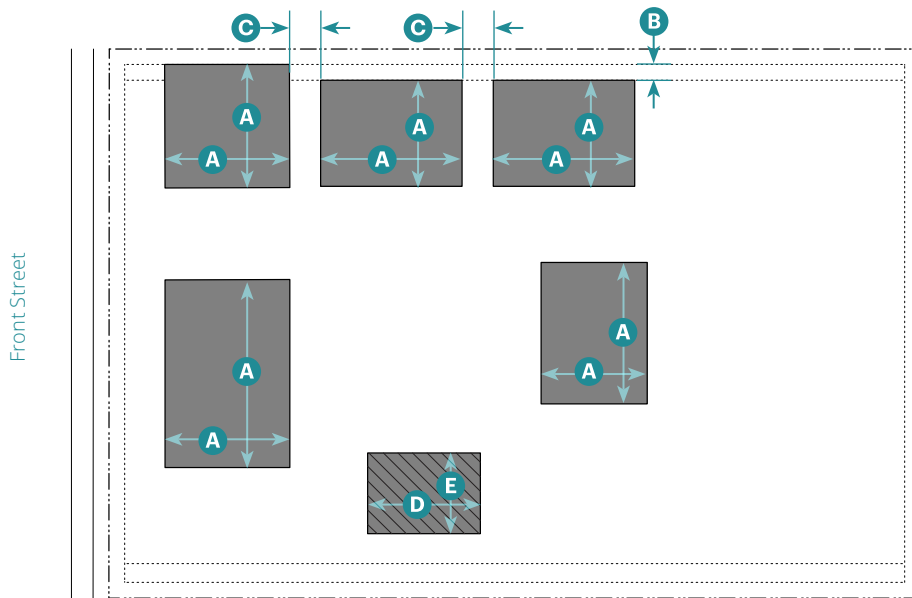

Key

- - - ROW/ Design Site Line
- Building Setback Line
- Building
- ▨ Community Building

3. Building Size and Massing

Height

Stories	1.5 max.
To Highest Eave/parapet	18' max.

Main Body¹

Building Length in Any Direction	40' max.	A
Buildings along Side and Rear		
Side Setback in Addition to Zone Setback	5' min.	B
Building Separation ²		C
Between 1-story Buildings	10' min.	
Between Buildings > 1-story	15' min.	

Community Building^{1,3}

Width	40' max.	D
Depth	30' max.	E

3. Building Size and Massing (Continued)

Wing(s)

Not Allowed

Facades shall be designed in compliance with Chapter 7 (Specific to Architectural Design).

No single-unit buildings allowed along the front or side street

¹ In compliance with Subsection 5 of the zone

² Including community building

³ Shall front on common open space and is not allowed along front or side street

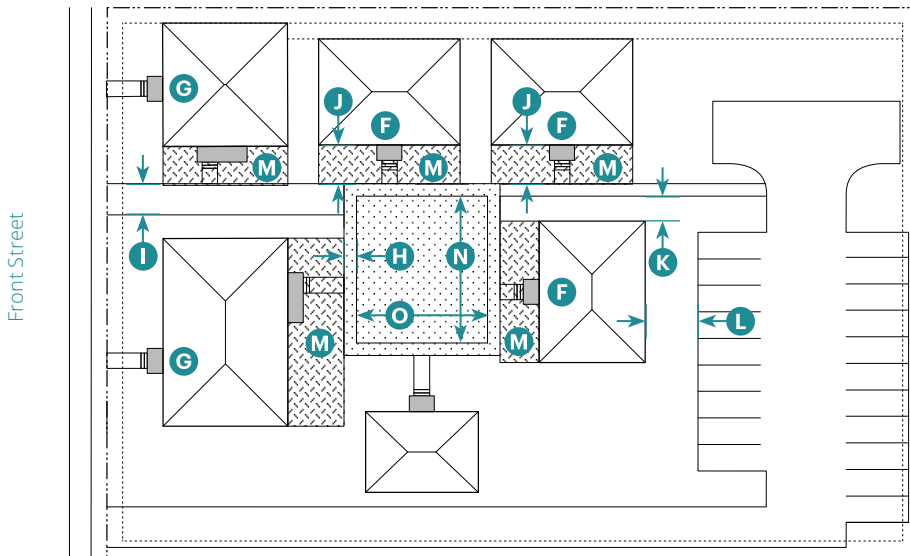

Key

- - - - ROW/ Design Site Line ■ Frontage
- Building Setback Line

4. Pedestrian Access

Main Entrance Location		
Buildings with 1 Unit ⁴	At Common Open Space	F
Buildings with 2 or more Units	At Front or Side Street	G
Pedestrian Path Width		
Along Buildings and Open Space	5' min.	H
At Front or Side Street Connection	10' min.	I
Pedestrian Path Setbacks		
From Building Entrance	12' min.	J
From Side of Building	8' min.	K

⁴Max. 40' from edge of common open space

5. Vehicle Access and Parking

- Offset from Buildings 5' min. **L**
- Driveway and parking location shall comply with standards in Subsection 7 of the zone.
- Parking not allowed along private or common open space.
- Parking may be covered, uncovered, or in a garage.
- Turnaround access required in compliance with Fire Department standards.
- Parking spaces shall be grouped in one or more parking area(s) at rear or side of design site.

Key

- Private Open Space
- ▨ Common Open Space

6. Open Space

Private Open Space per Building			
Required for full length of building at all facades adjacent or abutting a pedestrian path or common open space M			
Common Open Space⁵	5 Bldgs.⁶	6-10 Bldgs.⁶	
Width	30' min.	50' min.	N
Depth	40' min.	100' min.	O

7. Miscellaneous

- Fencing**
- Fencing only allowed around or between individual buildings and shall not exceed 36" in height.
- Visibility shall be maintained through the fencing.
- ⁵Shall provide access from front or side street
- ⁶Not including community building

7. Main Body Massing Composition

Select from the allowed massing proportions and apply the standards to the main body width for each building in compliance with the following standards.

1-2 Units per Building

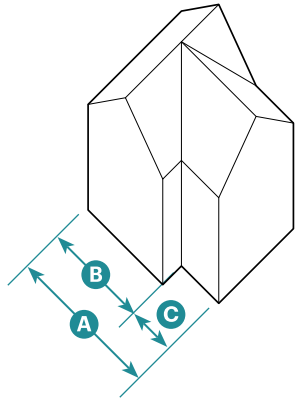

Gable L (2/3 + 1/3)

Main Body Number of Bays	3 bays ¹
Main Body Width	Max. allowed by Subsection 3 of this building type
Wall Length	40' max.

1-4 Units per Building

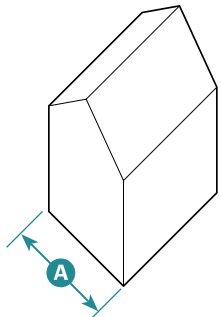

Front Gable

Main Body Number of Bays	2-3 bays ¹
Main Body Width	Max. allowed by Subsection 3 of this building type
Wall Length	40' max.

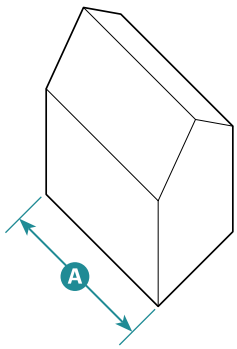

Side Gable

Main Body Number of Bays	3-5 bays ¹
Main Body Width	Max. allowed by Subsection 3 of this building type
Wall Length	40' max.

7. Main Body Massing Composition (Continued)

2-4 Units per Building

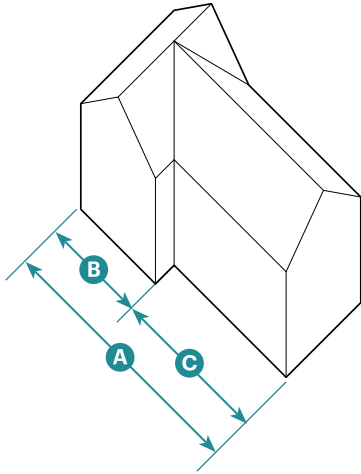

Gable L (2/5 + 3/5)

Main Body Number of Bays	3-6 bays ¹
Main Body Width	Max. allowed by Subsection 3 of this building type
Wall Length	40' max.

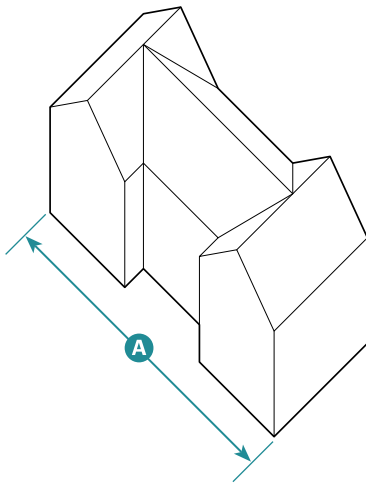

Twin Gable

Main Body Number of Bays	3-6 bays ¹
Main Body Width	Max. allowed by Subsection 3 of this building type
Wall Length	40' max.

¹ Required on facades along a street or civic space.

05.130 Multiplex



Example of Multiplex



Example of Multiplex



Example of Multiplex including bonus height

1. Description

A medium-to-large-sized, detached, House-Scale Building that consists of up to 18 side-by-side and/or stacked units, typically with one shared entry. The type is scaled to fit within moderate-intensity neighborhoods.

Synonym: Mansion Apartment

2. Number of Units

	T4SN.S	T4CN.M	T4SMS.S	T4CMS	T5CN
Units per Building	8 max.	12 max.	12 max.	18 max.	18 max.
Buildings per Design Site	1 max.				

General Note: Photos on this page are illustrative, not regulatory.

Alley access required if alley exists

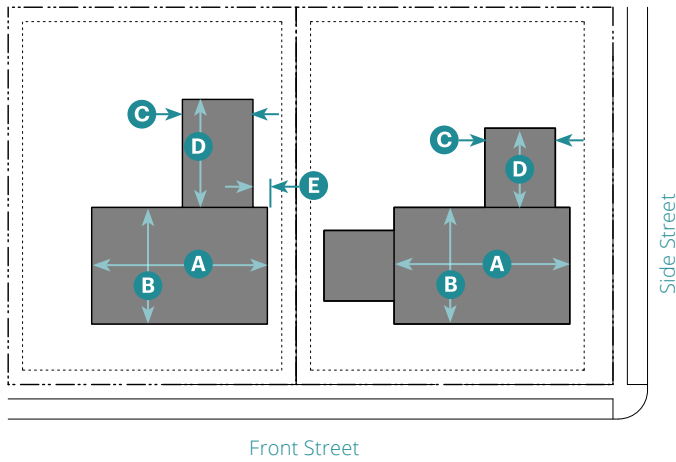

Alley access required if alley exists

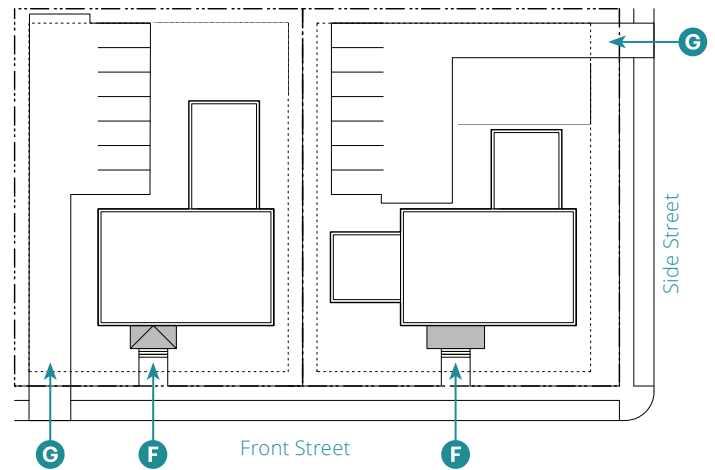

Key

- - - ROW/ Design Site Line
- Building Setback Line
- Building

3. Building Size and Massing

Height	T4SN.S	T4CN.M	T5CN
	T4SMS.S	T4CMS	
Stories	2.5 max.	3.5 max.	4.5 max.
Main Body¹			
Width	— 60' max. —		80' max. A
Depth	— 60' max. — B		
Wing(s)^{1,2}			
Width	— 24' max. —		C
Depth	— 40' max. — D		
Separation between Wings on same facade	— 15' min. —		
Offset from Main Body	— 5' min. —		E

Facades shall be designed in compliance with Chapter 7 (Specific to Architectural Design).

¹ In compliance with Subsection 5 of the zone

² Height is limited to 1 story less than main body and 10' less to highest eave/parapet.

Key

- - - ROW/ Design Site Line
- Building Setback Line
- Frontage

4. Pedestrian Access

Main Entrance Location Front Street **F**

Units located in the main body shall be accessed by a common entry along the front street.

On corner design sites, units in a wing may enter from the side street.

5. Vehicle Access and Parking

Driveway and parking location shall comply with standards in Subsection 7 of the zone. **G**

Parking may be covered, uncovered, or in a garage.

6. Open Space

Common or private open space is not required.

7. Main Body Massing Composition

Select from the allowed massing proportions and apply the standards to the main body width in compliance with Chapter 7 (Specific to Architectural Design) and the following standards.

Side Gable

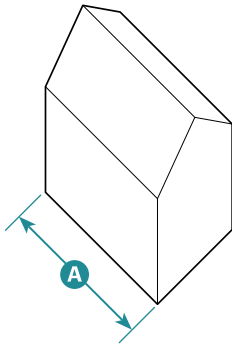

This massing type is a simple rectilinear form that is longer than it is deep. The roof is sloped and may be either hipped or gabled.

Main Body	
Number of Bays	Flexible ¹ A
Main Body Width	Max. allowed by Subsection 3 of this building type
Wall Length	40' max.
Wing(s)	
Number of Bays	Not Required

Gable L (2/3 + 1/3)

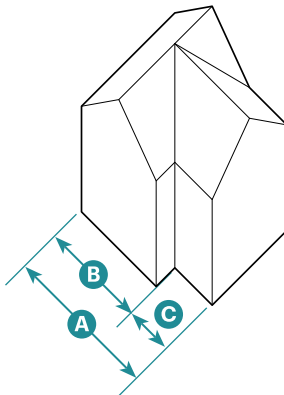

This massing type divides the facade into three equal parts, 1 part projecting and 2/3 projecting towards front property line. The roof is sloped with a gable at the projecting 1/3.

Main Body	
Number of Bays	3-6 bays ¹ A
Main Body Width	Max. allowed by Subsection 3 of this building type
Massing Proportions	2/3 B
	1/3 C
Wall Length	40' max.
Wing(s)	
Number of Bays	Not Required

¹ Required on facades along a street or civic space.

7. Main Body Massing Composition (Continued)

Gable L (2/5 + 3/5)

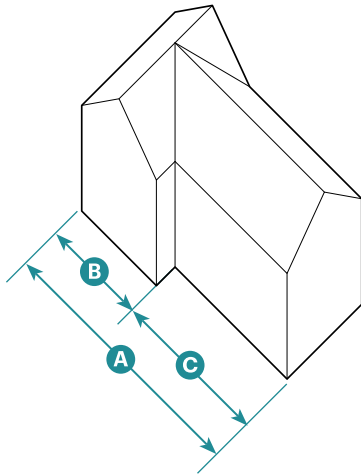

This massing type divides the facade into five equal parts, with two parts projecting and three parts set back to create a shallow forecourt. The roof is sloped with gables at the projecting two parts.

Main Body	
Number of Bays	5 bays ¹ A
Main Body Width	Max. allowed by Subsection 3 of this building type
Massing Proportions	2/5 B
	3/5 C
Wall Length	40' max.

Wing(s)	
Number of Bays	Not Required

Center Gable (1/3 + 1/3 + 1/3)

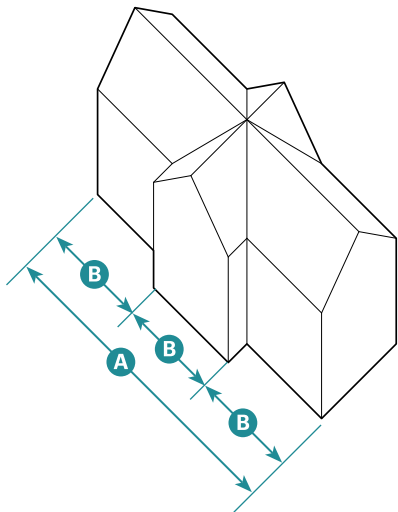

This massing type divides the facade into three equal parts, with the middle third projecting. The roof is sloped and may be either hipped or gabled.

Main Body	
Number of Bays	3-6 bays ¹ A
Main Body Width	Max. allowed by Subsection 3 of this building type
Massing Proportions	1/3 each B
Wall Length	40' max.

Wing(s)	
Number of Bays	Not Required

7. Main Body Massing Composition (Continued)

Twin Gable

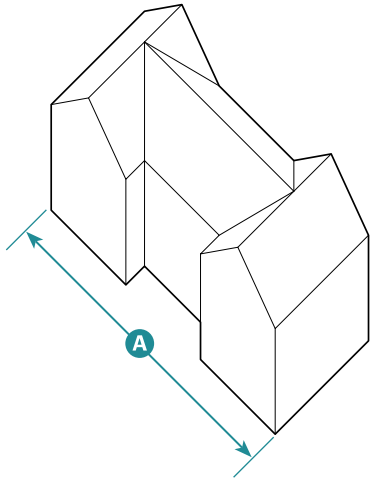

This massing type divides the facade into three parts, with the middle part set back slightly to create a shallow open space. The roof is sloped and may be either hipped or gabled.

Main Body	
Number of Bays	3-6 bays ¹ A
Main Body Width	Max. allowed by Subsection 3 of this building type
Wall Length	40' max.

Wing(s)	
Number of Bays	Not Required

Center Gable (1/3 + 1/3 + 1/3)

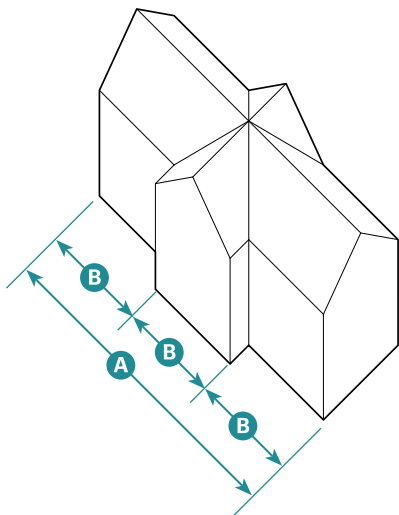

This massing type divides the facade into three equal parts, with the middle third projecting. The roof is sloped and may be either hipped or gabled.

Main Body	
Number of Bays	3-6 bays ¹ A
Main Body Width	Max. allowed by Subsection 3 of this building type
Massing Proportions	1/3 each B
Wall Length	40' max.

Wing(s)	
Number of Bays	Not Required



Example of Core Townhouse



Example of Core Townhouse



Example of Core Townhouse

1. Description

A large-sized, typically attached, Block-Scale Building (10 to 16 units) with a rear setback. Each Core Townhouse consists of up to two stacked units. As allowed by the zone, the type may also be detached with minimal separations between buildings. The type is typically located within high-intensity neighborhoods or on, or near, a neighborhood main street.

Synonym: Rowhouse

2. Number of Units

	T4CMS	T5CN
Units per Building	2 max.	3 max.
Buildings per Design Site	1 max.	1 max.
Buildings per Run	8 max.	8 max.

General Note: Photos on this page are illustrative, not regulatory.

Alley access required if alley exists

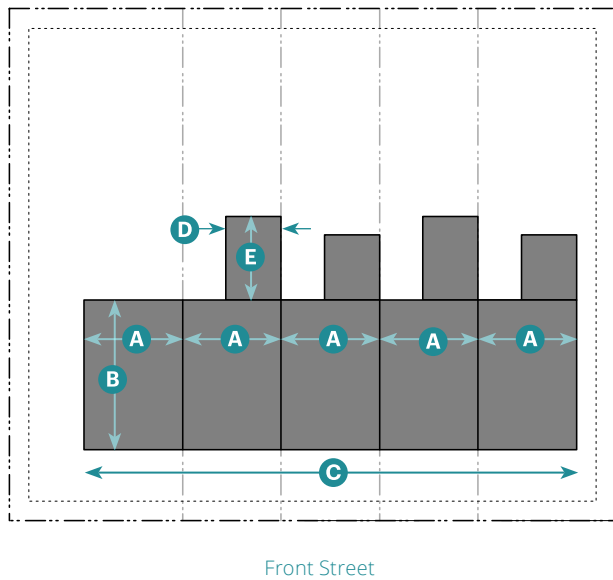

Alley access required if alley exists

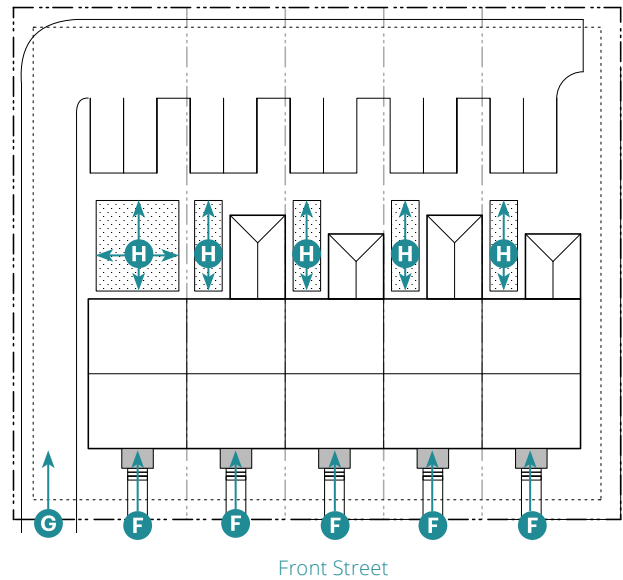

Key

- - - ROW/ Design Site Line ■ Building
- Building Setback Line

3. Building Size and Massing

Height	T4CMS	T5CN
Stories	3.5 max. ¹	5 max. ²
Main Body³		
Width per Unit ⁵	— 18' min. —	A
Depth per Unit ⁵	— 48' max. —	B
Width per Run	— 200' max —	C
Wing(s)^{3,4}		
Width	— 14' max. —	D
Depth	— 25' max. —	E
Separation between Wings on same facade	— 10' min. —	

Facades shall be designed in compliance with Chapter 7 (Specific to Architectural Design).

¹ Reflects 2 stacked units

² Reflects 3 stacked units; 4.5 stories max. for 2 stacked units

³ In compliance with Subsection 5 of the zone

⁴ Height is limited to 1 story less than main body and 10' less to highest eave/parapet.

⁵ Includes stacked units

Key

- - - ROW/ Design Site Line ■ Frontage
- Building Setback Line □ Private Open Space

4. Pedestrian Access

Main Entrance Location Front Street **F**

Each unit shall have an individual entry facing a street or be perpendicular to a street within an alcove facing a street.

5. Vehicle Access and Parking

Driveway and parking location shall comply with standards in Subsection 7 of the zone. **G**

Parking may be covered, uncovered, or in a garage.

6. Open Space

Private Open Space		
Width	8' min.	H
Depth	8' min.	H

Required setbacks and driveways do not count toward open space.

Required private open space shall be located behind the main body of the building.

7. Main Body Massing Composition

Select from the allowed massing proportions and apply the standards to the main body width in compliance with Chapter 7 (Specific to Architectural Design) and the following standards.

Side Gable

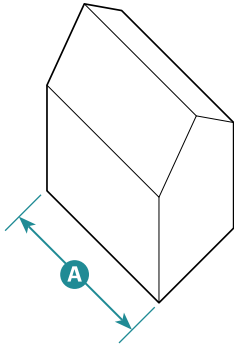

This massing type is a simple rectilinear form that is longer than it is deep. The roof is sloped and may be either hipped or gabled.

Main Body

Number of Bays	Flexible ¹	A
Main Body Width	Max. allowed by Subsection 3 of this building type	
Wall Length	40' max.	

Wing(s)

Number of Bays	Not Required
----------------	--------------

Twin Gable

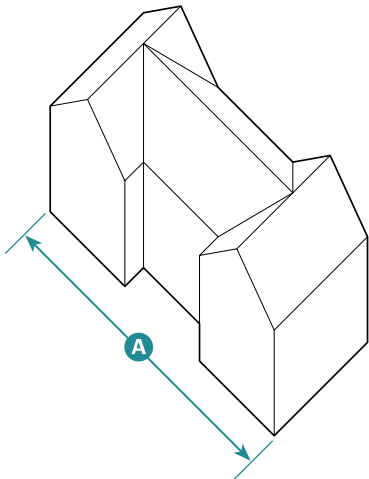

This massing type divides the facade into three parts, with the middle part set back slightly to create a shallow open space. The roof is sloped and may be either hipped or gabled.

Main Body

Number of Bays	Flexible ¹	A
Main Body Width	Max. allowed by Subsection 3 of this building type	
Wall Length	40' max.	

Wing(s)

Number of Bays	Not Required
----------------	--------------

¹ Required on facades along a street or civic space.

This page intentionally left blank



Example of Terraced Courtyard Building (Courtesy of ONNI)



Example of Terraced Courtyard Building (Courtesy of Google Maps)



Example of Terraced Courtyard Building (Courtesy of Google Maps)

1. Description

A detached, Block-Scale Building on sloped sites that consists of a pair of buildings facing a common open space. Each of the two buildings contains 6 to 9 attached, partially overlapping units creating terraces. Each unit uses the adjacent terrace on the roof of the unit below as private open space. The type is for neighborhoods on slopes over 25 percent to enable each unit to have an uninterrupted view forward.

Synonym: Cascading Building

2. Number of Units

Units per Building	6 min.; 9 max.
Terraces per Building	1 for each unit
Buildings per Design Site	2 max.

General Note: Photos on this page are illustrative, not regulatory.

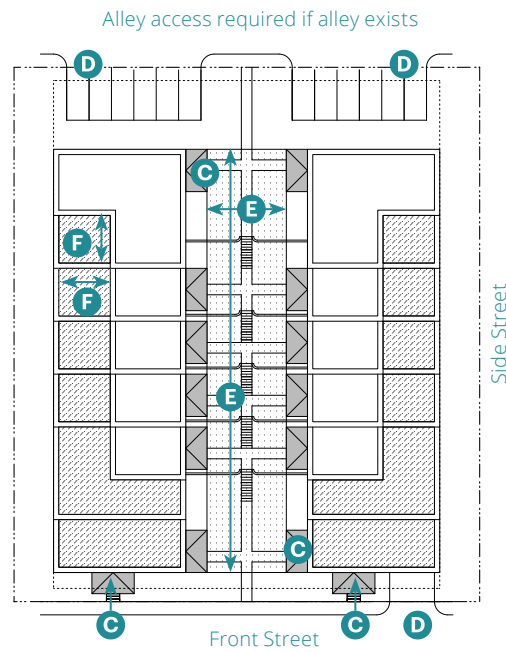
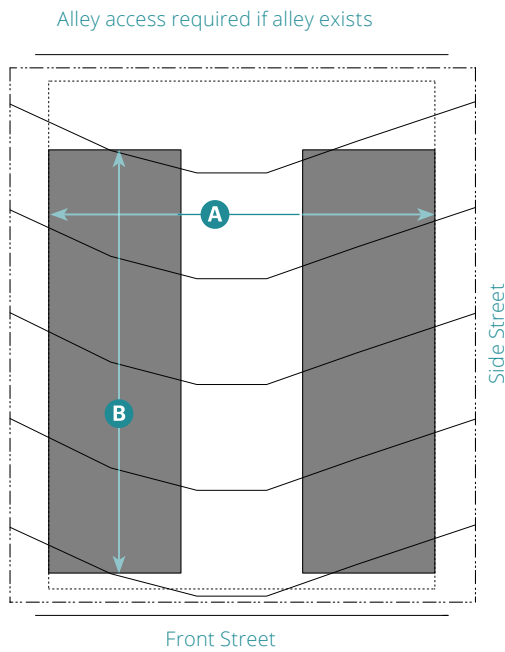

Key

- - - - ROW/ Design Site Line
- Building Setback Line
- Building

Key

- - - - ROW/ Design Site Line
- Building Setback Line
- Frontage
- ▨ Common Open Space
- ▩ Private Open Space

3. Building Size and Massing

Height

Stories	2 max.	Overall	25' max.
---------	--------	---------	----------

Building Overall¹

Width	150' max. including min. common open space (See E)	A
	160' max. including min. 40' wide common open space	

Depth	180' max. including min. common open space (See E)	B
	250' max. including min. 40' wide common open space	

Wing(s)

Not Allowed

Facades shall be designed in compliance with Chapter 7 (Specific to Architectural Design).

Facades along the walls facing the side design site lines are required to include glazing: 25% min. per story per unit.

¹ In compliance with Subsection 5 of the zone

4. Pedestrian Access

Main Entrance Location **C**

All Units	Common open space
Corner Units	Additional entrance from front or side street(s)

Unit entries must be combined with the following frontage types in Chapter 6 (Specific to Private Frontage Types): Porch Projecting, Porch Engaged, Dooryard, or Terrace.

5. Vehicle Access and Parking

Driveway and parking location shall comply with the standards in Subsection 7 of the zone. **D**

Parking is required in a podium or subterranean garage.

If the design site includes an alley or rear service drive, up to 12 spaces are allowed at the rear of the design site provided that the spaces are divided into two areas on either side of the common open space extended through the parking space depth.

6. Open Space

Common Open Space **E**

Width, Clear	30' min.
Depth	Full length of Design Site

Private Open Space per Terrace **F**

Width, Depth	12' min.
--------------	----------

7. Main Body Massing Composition

Select from the allowed massing proportions and apply the standards to the main body width in compliance with Chapter 7 (Specific to Architectural Design) and the following standards.

Flat Box per Terrace

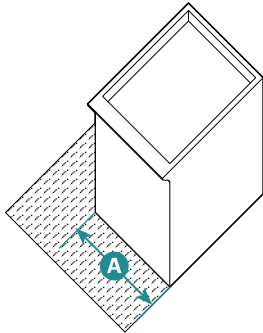

This massing type is a simple rectilinear form that is deeper than it is long. The roof is flat.

Main Body

Number of Bays	Flexible	A
Main Body Width	Max. allowed by Subsection 3 of this building type	
Wall Length	40' max.	

Wing(s)

Number of Bays	Not Required
----------------	--------------

Flat Bar per Terrace

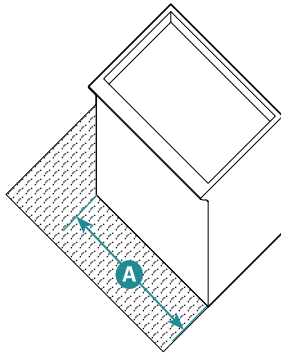

This massing type is a simple rectilinear form that is longer than it is deep. The roof is flat.

Main Body

Number of Bays	Flexible	A
Main Body Width	Max. allowed by Subsection 3 of this building type	
Wall Length	40' max.	

Wing(s)

Number of Bays	Not Required
----------------	--------------

Flat L (2/5 + 3/5) per Terrace

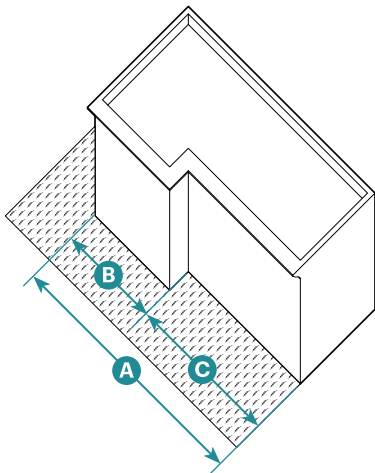

This massing type divides the facade into five equal parts, with two parts projecting and three parts set back to create a shallow forecourt. The roof is flat.

Main Body

Number of Bays	Flexible	A
Main Body Width	Max. allowed by Subsection 3 of this building type	
Massing Proportions	2/5	B
	3/5	C
Wall Length	40' max.	

Wing(s)

Number of Bays	Not Required
----------------	--------------

This page intentionally left blank



Example of Core Courtyard



Example of Core Courtyard



Example of Core Courtyard

1. Description

A detached or attached, Block-Scale Building in an L-, U-, or O-shaped that consists of up to 50 attached and/or stacked units, accessed from one or more shared courtyards. The shared court is common open space. The type is typically integrated into moderate-to-high-intensity neighborhoods and on main streets with a non-residential ground floor along the adjacent street.

Synonym: Courtyard Apartment

2. Number of Units

	T4CMS	T5CN	T5CMS
Units per Design Site	24 max.	50 max.	50 max.
Buildings per Design Site	—————2 max.—————		

General Note: Photos on this page are illustrative, not regulatory.

Alley access required if alley exists

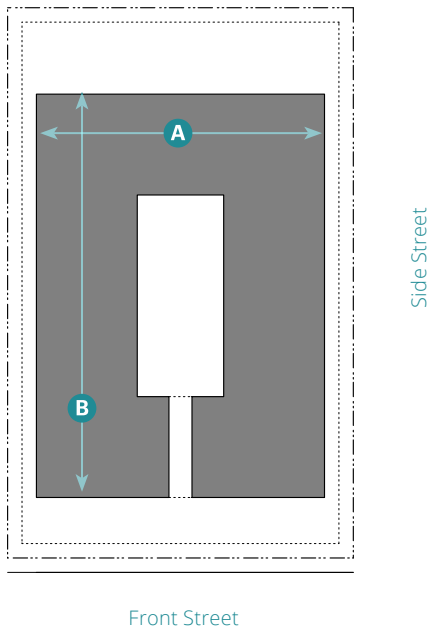

Alley access required if alley exists

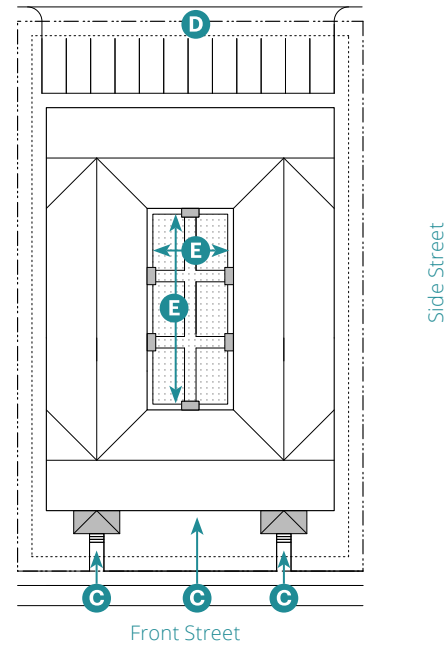

Key

- - - - ROW/ Design Site Line
- Building Setback Line
- Building

3. Building Size and Massing

Height	T4CMS	T5CN	T5CMS
Stories	3.5 max.	5 max.	6 max. ¹
Main Body ^{2,3}			
Width	100' max.	120' max.	200' max. A
Depth	140' max.	180' max.	180' max B

Wing(s)

Not Allowed

Facades shall be designed in compliance with Chapter 7 (Specific to Architectural Design).

If building is designed as two separate buildings, the separation area(s) shall be designed as a courtyard

¹ For 50% of main body

² In compliance with Subsection 5 of the zone

³ This type may be designed as two adjacent buildings, not more than 30' apart, in compliance with the standards of this Subsection.

4. Pedestrian Access

Main Entrance Location ⁴	Courtyard or Street	C
Distance between Unit Entries	30' max.	

Key

- - - - ROW/ Design Site Line
- Building Setback Line
- Frontage
- Common Open Space

4. Pedestrian Access (Continued)

⁴ The main entry of ground floor units shall be directly off of a courtyard or street, whichever is closer.

5. Vehicle Access and Parking

Driveway and parking location shall comply with standards in Subsection 7 of the zone. **D**

Parking may be covered, uncovered, or in a garage.

6. Open Space

Common Open Space

Main Body Height ⁵	Size	E
3.5 to 6 Stories	40' min. x 75' min.	
Up to 3.5 Stories	30' min. x 65' min.	

Building separation shall be designed as a courtyard.

Courtyards shall be accessible from the front street.

Multiple courtyards shall be connected via a passage through or between buildings.

Buildings shall define at least three walls of a courtyard.

Up to 1/3 of the shared court(s) may be used for stormwater management if designed as a rain garden or bioswale.

⁵ Height is measured at the highest story along courtyard.

7. Main Body Massing Composition

Select from the allowed massing proportions and apply the standards to the main body width for each building in compliance with Chapter 7 (Specific to Architectural Design) and the following standards.

Flat Front Courtyard

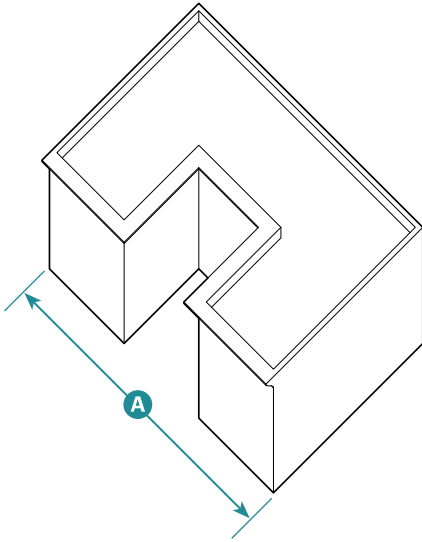

This massing type divides the front facade into three parts, with the middle part set back substantially to create a deep courtyard accessed from the street. The roof is flat.

Main Body

Number of Bays	6-9 bays ¹	A
Main Body Width	Max. allowed by Subsection 3 of this building type	
Wall Length	40' max.	

Wing(s)

Number of Bays	Not Required
----------------	--------------

Flat Rear Courtyard

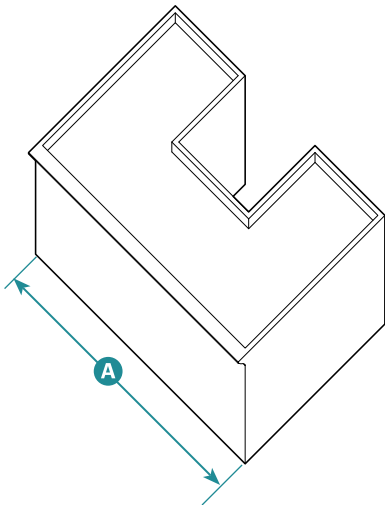

This massing type divides the rear facade into three parts, with the middle part set back substantially to create a deep courtyard not visible from the street. The roof is flat.

Main Body

Number of Bays	6-9 bays ¹	A
Main Body Width	Max. allowed by Subsection 3 of this building type	
Wall Length	40' max.	

Wing(s)

Number of Bays	Not Required
----------------	--------------

¹ Required on facades along a street or civic space.

7. Main Body Massing Composition (Continued)

Gabled Front Courtyard

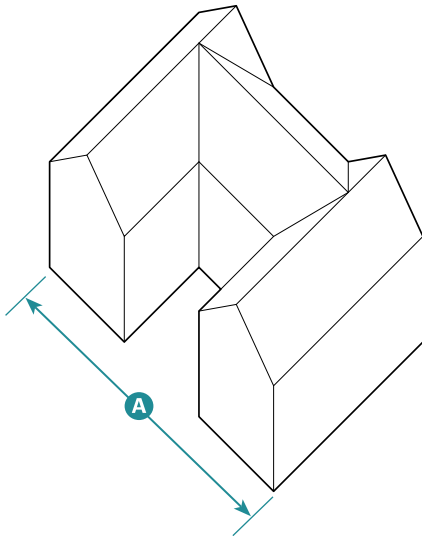

This massing type divides the front facade into three parts, with the middle part set back substantially to create a deep courtyard accessed from the street. The roof is sloped and may be either hipped or gabled.

Main Body

Number of Bays	6-9 bays ¹	A
Main Body Width	Max. allowed by Subsection 3 of this building type	
Wall Length	40' max.	

Wing(s)

Number of Bays	Not Required
----------------	--------------

Gabled Rear Courtyard

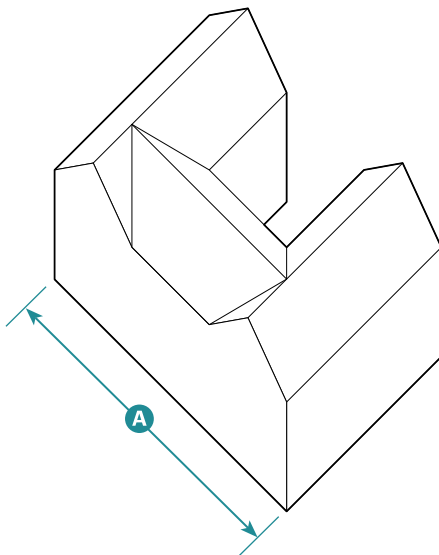

This massing type divides the rear facade into three parts, with the middle part set back substantially to create a deep courtyard not visible from the street. The roof is sloped and may be either hipped or gabled.

Main Body

Number of Bays	6-9 bays ¹	A
Main Body Width	Max. allowed by Subsection 3 of this building type	
Wall Length	40' max.	

Wing(s)

Number of Bays	Not Required
----------------	--------------

¹ Required on facades along a street or civic space.

7. Main Body Massing Composition (Continued)

Flat Closed Courtyard

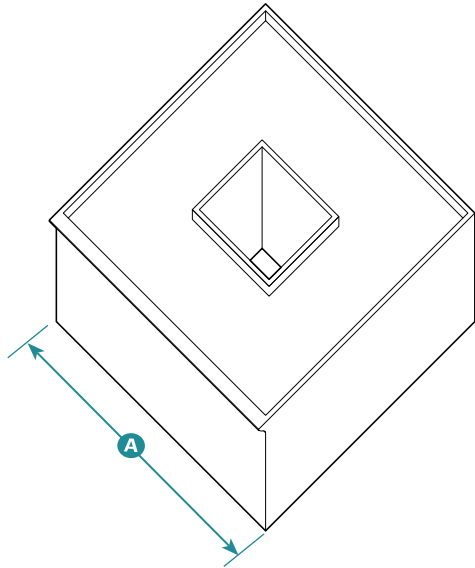

This massing type fronts a courtyard with building facades in all 4 sides. Courtyard not visible from the street. The roof is flat.

Main Body	
Number of Bays	6-9 bays ¹ A
Main Body Width	Max. allowed by Subsection 3 of this building type
Wall Length	40' max.

Wing(s)	
Number of Bays	Not Required

Gabled Closed Courtyard

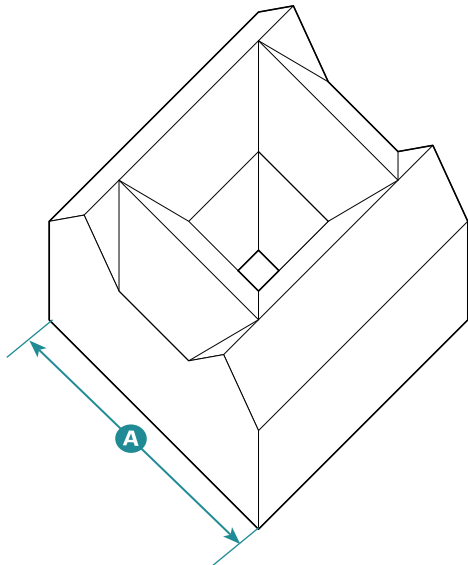

This massing type fronts a courtyard with building facades in all 4 sides. Courtyard not visible from the street. The roof is sloped and may be either hipped or gabled.

Main Body	
Number of Bays	6-9 bays ¹ A
Main Body Width	Max. allowed by Subsection 3 of this building type
Wall Length	40' max.

Wing(s)	
Number of Bays	Not Required

¹ Required on facades along a street or civic space.

This page intentionally left blank



Example of Main Street Building



Example of Main Street Building



Example of Main Street Building

1. Description

A small-to-large-sized, Block-Scale Building, typically attached, but may be detached. The type is intended to provide a vertical mix of uses with ground-floor retail, office, or service uses and upper-floor service or residential uses. The type makes up the primary component of neighborhood and downtown main streets, therefore being a key component to providing walkability.

2. Number of Units

Units per Building	Unrestricted
Buildings per Design Site	1 max.

General Note: Photos on this page are illustrative, not regulatory.

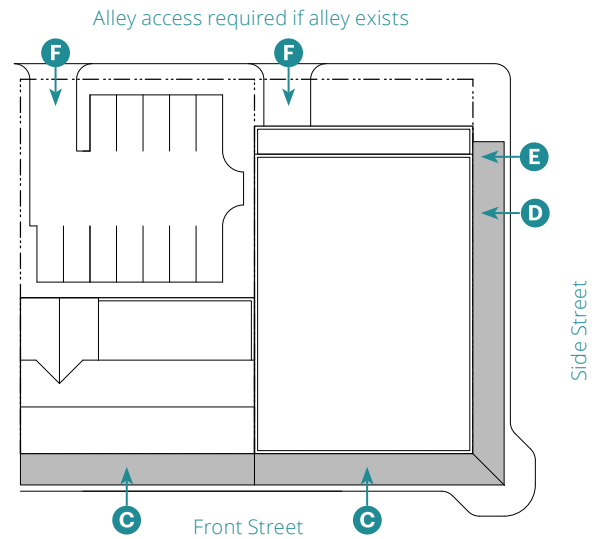
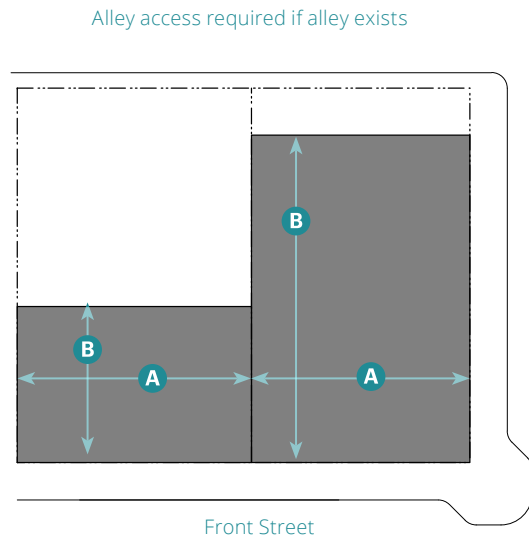

Key

- ROW/ Design Site Line ■ Building
- Building Setback Line

3. Building Size and Massing

Height	T4SMS.S	T4CMS	T5CMS
Stories	2.5 max.	3.5 max.	5 max.
Main Body²			
Width	100 max.	150 max.	200 max. (A)
Depth	90 max.	120 max.	280 max. (B)

Wing(s)

Not Allowed

Facades shall be designed in compliance with Chapter 7 (Specific to Architectural Design).

² In compliance with Subsection 5 of the zone

Key

- ROW/ Design Site Line ■ Frontage
- Building Setback Line □ Outline of Building above

4. Pedestrian Access

- Distance between Entries to Ground Floor Shops 50' max.
- Upper floor units shall be accessed by a common entry **(C)** along the front street.
- Ground floor shops shall have individual entries along the adjacent street. **(D)**
- Ground floor units allowed along side street at least 60' from front of design site.
- On corner design sites, units in a wing or accessory structure may enter from the side street. **(E)**

5. Vehicle Access and Parking

- Driveway and parking location shall comply with standards in Subsection 7 of the zone. **(F)**
- Parking may be covered, uncovered, or in a garage.

6. Open Space

Common or private open space is not required.

7. Main Body Massing Composition

Select from the allowed massing proportions and apply the standards to the main body width in compliance with Chapter 7 (Specific to Architectural Design) and the following standards.

Flat Box

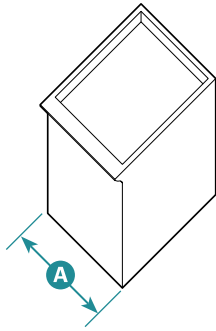

This massing type is a simple rectilinear form that is deeper than it is long. The roof is flat.

Main Body

Number of Bays	Flexible ¹	A
Main Body Width	Max. allowed by Subsection 3 of this building type	
Wall Length	40' max.	

Wing(s)

Number of Bays	Not Required
----------------	--------------

Flat Bar

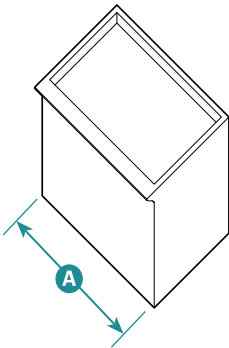

This massing type is a simple rectilinear form that is longer than it is deep. The roof is flat.

Main Body

Number of Bays	Flexible ¹	A
Main Body Width	Max. allowed by Subsection 3 of this building type	
Wall Length	40' max.	

Wing(s)

Number of Bays	Not Required
----------------	--------------

Flat L (2/5 + 3/5)

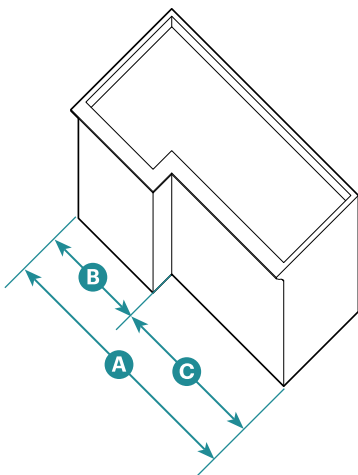

This massing type divides the facade into five equal parts, with two parts projecting and three parts set back to create a shallow forecourt. The roof is flat.

Main Body

Number of Bays	Flexible ¹	A
Main Body Width	Max. allowed by Subsection 3 of this building type	
Massing Proportions	2/5	B
	3/5	C
Wall Length	40' max.	

Wing(s)

Number of Bays	Not Required
----------------	--------------

¹ Required on facades along a street or civic space.

7. Main Body Massing Composition (Continued)

Flat L (2/3 + 1/3)

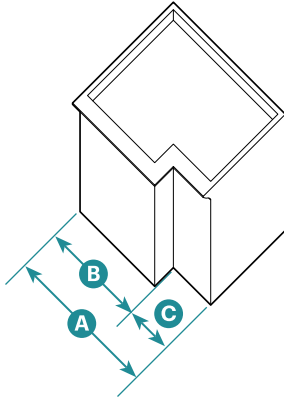

This massing type divides the facade into three equal parts, 1 part projecting with a gable roof and 2/3 projecting towards front property line. The roof is flat.

Main Body	
Number of Bays	Flexible ¹ A
Main Body Width	Max. allowed by Subsection 3 of this building type
Massing Proportions	2/3 B
	1/3 C
Wall Length	40' max.

Wing(s)	
Number of Bays	Not Required

Flat T (1/3 + 1/3 + 1/3)

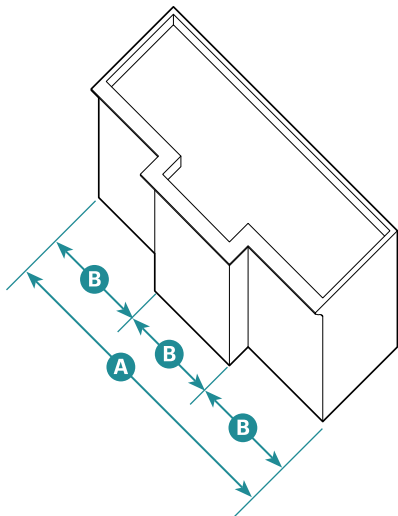

This massing type divides the facade into three equal parts, with the middle third projecting. The roof is flat.

Main Body	
Number of Bays	Flexible ¹ A
Main Body Width	Max. allowed by Subsection 3 of this building type
Massing Proportions	1/3 each B
Wall Length	40' max.

Wing(s)	
Number of Bays	Not Required

Flat Forecourt

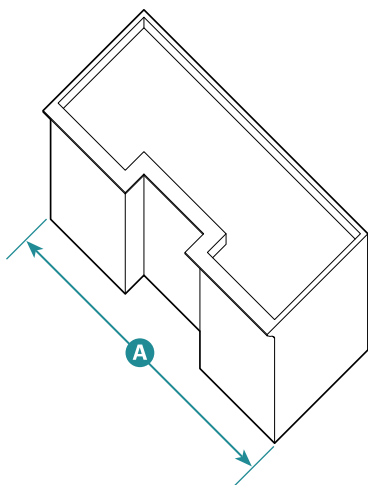

This massing type divides the facade into three parts, with the middle part set back slightly to create a shallow open space. The roof is flat.

Main Body	
Number of Bays	Flexible ¹ A
Main Body Width	Max. allowed by Subsection 3 of this building type
Wall Length	40' max.

Wing(s)	
Number of Bays	Not Required

7. Main Body Massing Composition (Continued)

Flat Courtyard

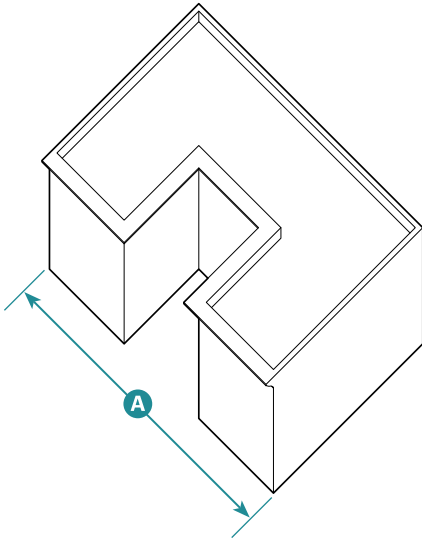

This massing type divides the facade into three parts, with the middle part set back substantially to create a deep open space. The roof is flat.

Main Body	
Number of Bays	Flexible ¹ A
Main Body Width	Max. allowed by Subsection 3 of this building type
Wall Length	40' max.
Wing(s)	
Number of Bays	Not Required

Front Gable

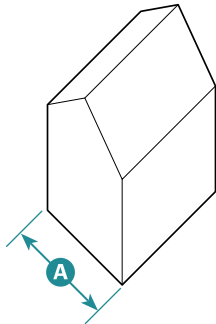

This massing type is a simple rectilinear form that is deeper than it is long. The roof is sloped and may be either hipped or gabled.

Main Body	
Number of Bays	Flexible ¹ A
Main Body Width	Max. allowed by Subsection 3 of this building type
Wall Length	40' max.
Wing(s)	
Number of Bays	Not Required

Side Gable

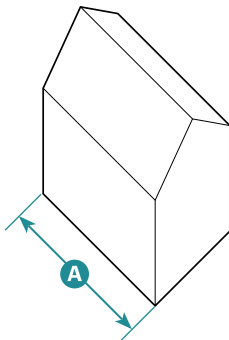

This massing type is a simple rectilinear form that is longer than it is deep. The roof is sloped and may be either hipped or gabled.

Main Body	
Number of Bays	Flexible ¹ A
Main Body Width	Max. allowed by Subsection 3 of this building type
Wall Length	40' max.
Wing(s)	
Number of Bays	Not Required

¹ Required on facades along a street or civic space.

7. Main Body Massing Composition (Continued)

Gable L (2/5 + 3/5)

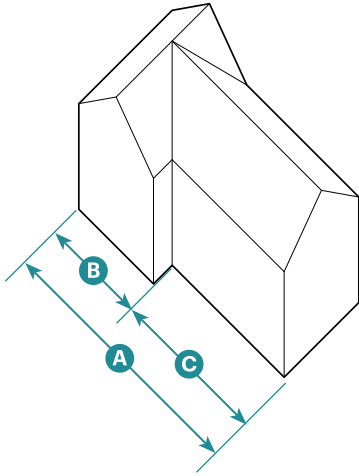

This massing type divides the facade into five equal parts, with two parts projecting and three parts set back to create a shallow forecourt. The roof is sloped with gables at the projecting two parts.

Main Body		
Number of Bays	Flexible ¹	A
Main Body Width	Max. allowed by Subsection 3 of this building type	
Massing Proportions	2/5	B
	3/5	C
Wall Length	40' max.	

Wing(s)	
Number of Bays	Not Required

Gable L (2/3 + 1/3)

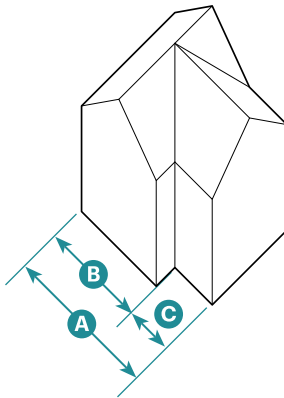

This massing type divides the facade into three equal parts, 1 part projecting and 2/3 projecting towards front property line. The roof is sloped with a gable at the projecting 1/3.

Main Body		
Number of Bays	Flexible ¹	A
Main Body Width	Max. allowed by Subsection 3 of this building type	
Massing Proportions	2/3	B
	1/3	C
Wall Length	40' max.	

Wing(s)	
Number of Bays	Not Required

Center Gable (1/3 + 1/3 + 1/3)

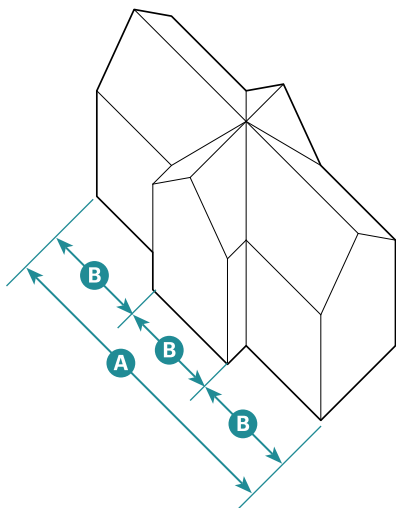

This massing type divides the facade into three equal parts, with the middle third projecting. The roof is sloped and may be either hipped or gabled.

Main Body		
Number of Bays	Flexible ¹	A
Main Body Width	Max. allowed by Subsection 3 of this building type	
Massing Proportions	1/3 each	B
Wall Length	40' max.	

Wing(s)	
Number of Bays	Not Required

7. Main Body Massing Composition (Continued)

Twin Gable

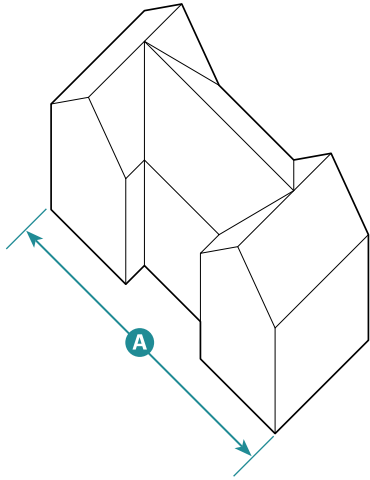

This massing type divides the facade into three parts, with the middle part set back slightly to create a shallow open space. The roof is sloped and may be either hipped or gabled.

Main Body	
Number of Bays	Flexible ¹ A
Main Body Width	Max. allowed by Subsection 3 of this building type
Wall Length	40' max.

Wing(s)	
Number of Bays	Not Required

Gabled Courtyard

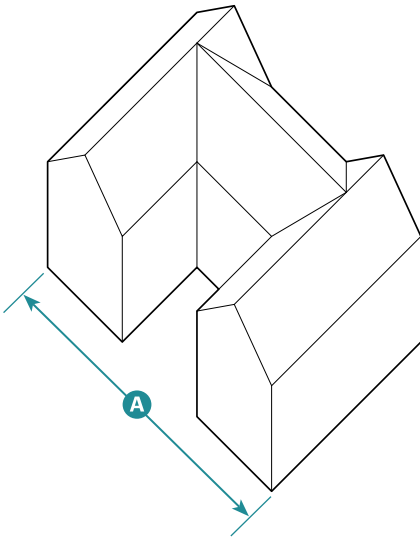

This massing type divides the facade into three parts, with the middle part set back substantially to create a deep open space. The roof is sloped and may be either hipped or gabled.

Main Body	
Number of Bays	Flexible ¹ A
Main Body Width	Max. allowed by Subsection 3 of this building type
Wall Length	40' max.

Wing(s)	
Number of Bays	Not Required

¹ Required on facades along a street or civic space.

This page intentionally left blank

Chapter 6: Specific to Private Frontage Types

Sections:

06.010	Purpose
06.020	Private Frontage Types
06.030	Overview of Private Frontage Types
06.040	Porch Projecting
06.050	Porch Engaged
06.060	Dooryard
06.070	Stoop
06.080	Forecourt
06.090	Maker Shopfront
06.100	Shopfront
06.110	Terrace
06.120	Gallery

06.010 Purpose

This Chapter provides the standards for private frontages ("frontages"). Private frontages are the components of a building that provide the transition and interface between the public realm (street and sidewalk) and the private realm (setback or building).

06.020 Private Frontage Types

1. The names of the private frontage types indicate their particular configuration or function and are not intended to limit uses within the associated building. For example, a Porch may be used by non-residential uses including, but not limited to, a restaurant or office, as allowed by the zone.
2. Each building is required to include at least one private frontage type along the front street or adjacent civic space. Buildings with entries along a side street are required to include at least one private frontage type on those facades.
3. The ground floor, for a minimum depth as identified in Subsection 4 of the zone, is required to be habitable/occupiable space in compliance with this Chapter. Accessibility is provided through the allowed private frontage types for each zone.
4. Private frontage types not listed in Subsection 8 of the zone are not allowed in that zone.
5. Each building may have multiple private frontage types in compliance with the allowed types in Subsection 8 of the zone.
6. Each private frontage type shall be located in compliance with the facade zone per Subsection 5 of the zone.
7. Standards are stated for the front and side street facades of a design site.

8. In addition to the zone's standards, each private frontage is further refined through these standards to further calibrate the type for its context.
9. Certain types are only allowed on a side street in the base zone (e.g., T4CMS) to implement the intended physical character.

06.030 Overview of Private Frontage Types

Table A (Private Frontage Types Overview) provides a summary of the allowed private frontage types in each zone. See referenced Section(s) for standards.

Table 06.030.A: Private Frontage Types Overview

Private Frontage Type	Specific Standards	Zones							
		T3		T4				T5	
		EN	SN	SN.S	CN.M	SMS.S	CMS	CN	CMS
Porch Projecting	06.040	P	P	P	P	P	X	P	X
Porch Engaged	06.050	P	P	P	P	P	X	P	X
Dooryard	06.060	P	P	P	P	O	O	P	X
Stoop	06.070	X	X	P	P	O	O	P	O
Forecourt	06.080	X	X	X	X	P	P	P	X
Maker Shopfront	06.090	X	X	X	X	O	O	X	O
Shopfront	06.100	X	X	X	X	P	P	X	P
Terrace	06.110	X	X	X	P	P	P	P	P
Gallery	06.120	X	X	X	X	P	P	X	P

Key

P = Allowed

O = Allowed Only on Side Street

X = Not Allowed

This page intentionally left blank

06.040 Porch Projecting



Example of a Projecting Porch



Example of a Projecting Porch



Example of a Projecting Porch

1. Description

The main facade of the building is set back from the front design site line with a covered structure encroaching into the front setback. The resulting setback area may be defined by a fence or hedge to spatially maintain the edge of the street. The Porch may be one or two stories, is open on three sides, with all habitable space located behind the building setback line.

General Note: Photos on this page are illustrative, not regulatory.

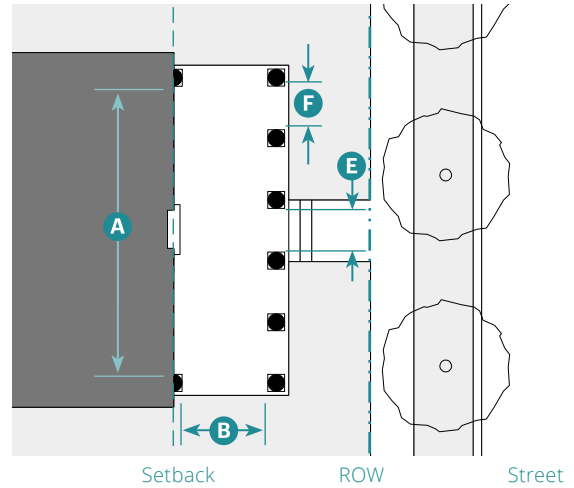
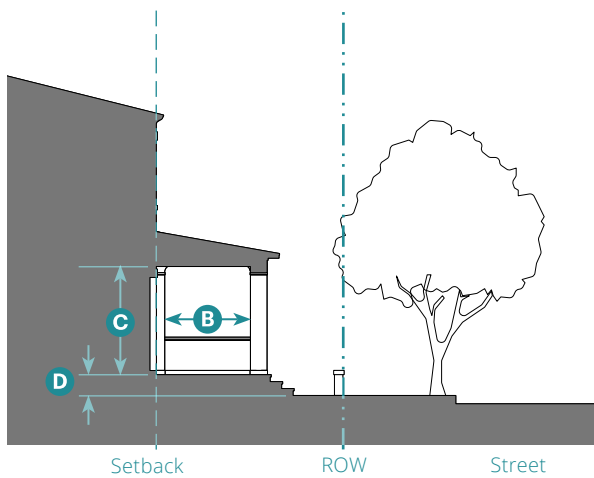

Key

--- ROW/ Design Site Line Setback Line

2. Size		
Width, Clear	15' min. ¹	A
Depth, Clear	8' min.	B
Height, Clear	8' min.	C
Stories	2 stories max.	
Finish Level above Sidewalk	12" min. ²	D
Pedestrian Access	3' wide min.	E
Distance between Porch columns shall be in compliance with selected architectural style in Chapter 7 (Specific to Architectural Design).		F

¹ Reduce to 8' min. and maximum 1 story when applied to Cottage Court Building Type

² Common entries may be set at grade per local and federal accessibility standards.

3. Miscellaneous

Porch shall be open on three sides and have a roof. Clear glass may be installed between the porch columns if the minimum size of individual panes is in compliance with the standards in Chapter 7 (Specific to Architectural Design).

The Porch is allowed to encroach into the front and side street setbacks in compliance with Subsection 6 of the zone. Ramps are required to be integrated along the side of the building to connect with the Projecting Porch.

The Porch shall be designed in compliance with the standards in Chapter 7 (Specific to Architectural Design) for the selected architectural style.

06.050 Porch Engaged



Example of an Engaged Porch



Example of a two-story Engaged Porch



Example of an Engaged Porch

1. Description

A portion of the main facade of the building is set back from the front design site line to create an area for a covered structure that projects from the facade that is set back. The Porch may project into the front setback. The resulting setback may be defined by a fence or hedge to spatially maintain the edge of the street. The Porch may be one or two stories and has two adjacent sides that are engaged to the building, while the other two sides are open.

General Note: Photos on this page are illustrative, not regulatory.

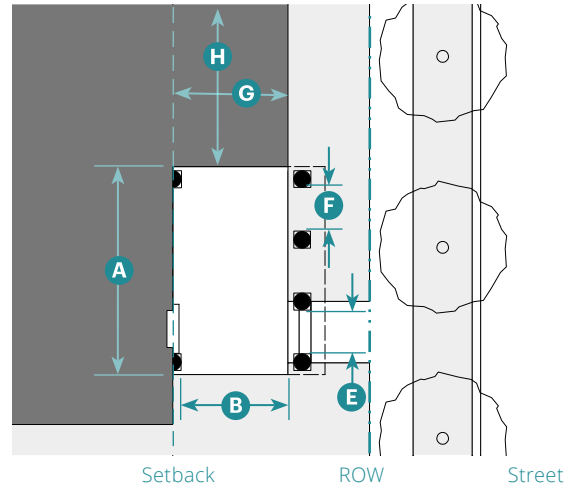
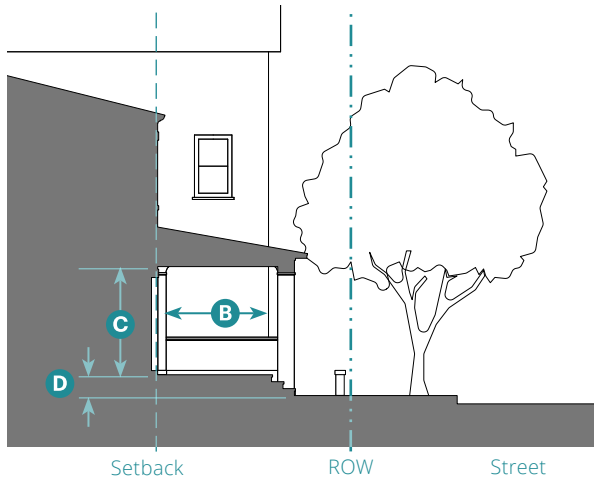

Key

--- ROW/ Design Site Line - - - - - Setback Line

2. Size		
Width, Clear	8' min.	A
Depth, Clear	8' min.	B
Height, Clear	8' min.	C
Stories	2 stories max.	
Finish Level above Sidewalk	12" min. ¹	D
Pedestrian Access	3' wide min.	E
Distance between Porch columns shall be in compliance with selected architectural style in Chapter 7 (Specific to Architectural Design).		F
Encroachment area of Building Facade		
Depth	6' max.	G
Width	1/3 min. of overall building facade	H

¹Common entries may be set at grade per local and federal accessibility standards.

3. Miscellaneous

Up to 20% of the building facade and porch(es) may project into the front setback line for the zone.

Porch shall be open on two sides and have a roof. Clear glass may be installed between the porch columns if the minimum size of individual panes is in compliance with the standards in Chapter 7 (Specific to Architectural Design).

The Porch is allowed to encroach into the front and side street setbacks in compliance with Subsection 6 of the zone. Ramps are required to be integrated along the side of the building to connect with the Engaged Porch.

The Porch shall be designed in compliance with the standards in Chapter 7 (Specific to Architectural Design) for the selected Architectural Style.

06.060 Dooryard



Example of a residential Dooryard



Example of a commercial Dooryard



Example of a residential Dooryard

1. Description

The main facade of the building is set back from the front design site line, which is defined by a low wall or hedge, creating a small private area between the sidewalk and the facade. Each Dooryard is separated from adjacent Dooryards. The Dooryard may be raised or at grade.

General Note: Photos on this page are illustrative, not regulatory.

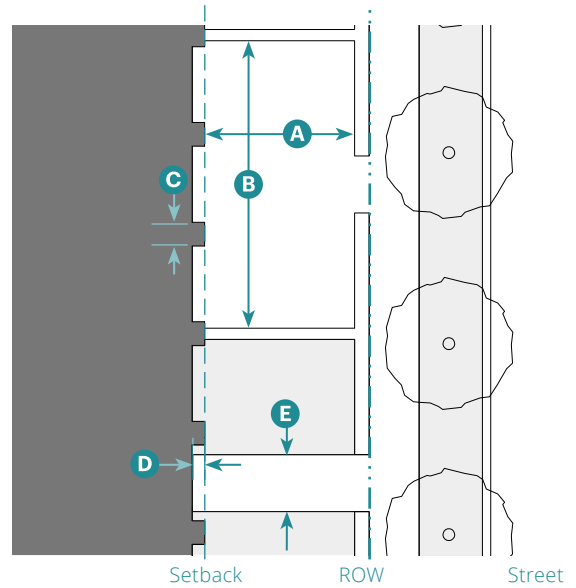
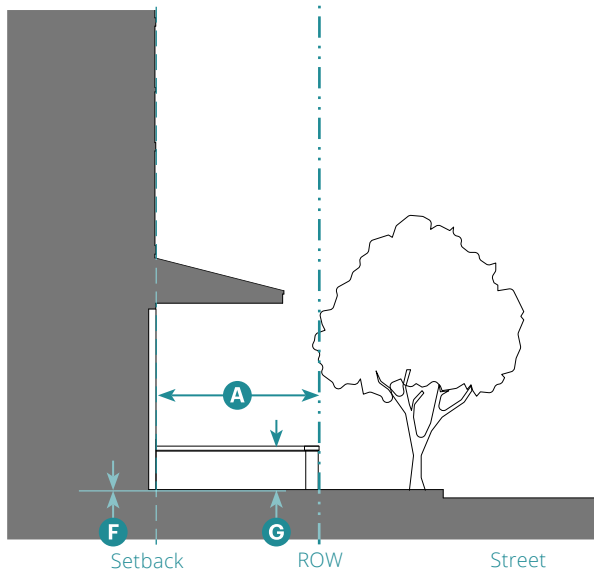

Key

- · - · - ROW/ Design Site Line - - - - - Setback Line

2. Size		
Depth, Clear	6' min.	A
Length	15' min.	B
Distance between Glazing	4' max.	C
Depth of Recessed Entries	3' max.	D
Pedestrian Access	3' wide min.	E
Finish Level above Sidewalk	12" max. ¹	F
Height of Dooryard Fence/Wall above Finish Level	36" max.	G

¹ Common entries may be set at grade per local and federal accessibility standards.

3. Miscellaneous

For live/work, retail, service, and restaurant uses, the Shopfront Frontage Type (06.100) may be applied.

Each Dooryard shall provide access to only one ground floor entry.

The Dooryard is allowed to encroach into the front and side street setbacks in compliance with Subsection 6 of the zone. Ramps are required to be integrated along the side of the building to connect with the Dooryard.

The Dooryard shall be designed in compliance with the standards in Chapter 7 (Specific to Architectural Design) for the selected architectural style.

06.070 Stoop



Example of a Stoop with paired entries



Example of a Stoop



Example of a Stoop

1. Description

The main facade of the building is near the front design site line with steps to an elevated entry. The Stoop is elevated above the sidewalk to provide privacy along the sidewalk-facing rooms. Stairs or ramps from the Stoop may lead directly to the sidewalk or may be parallel to the sidewalk.

General Note: Photos on this page are illustrative, not regulatory.

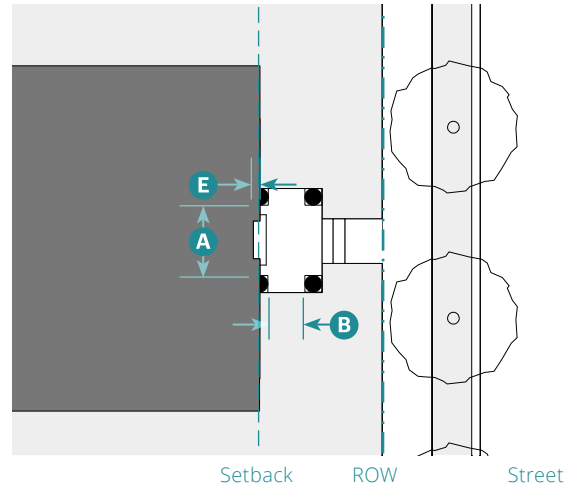
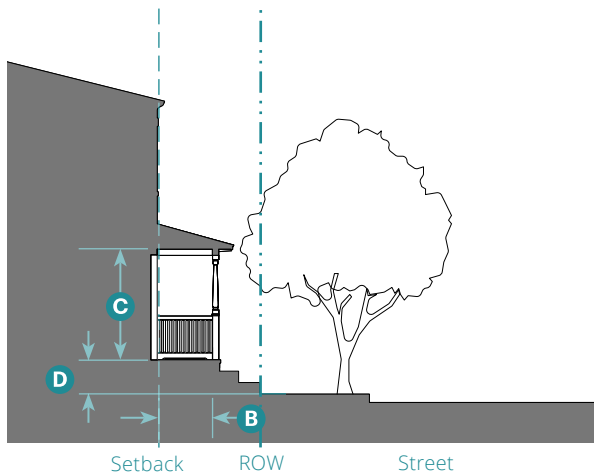

Key

--- ROW/ Design Site Line - - - - - Setback Line

2. Size		
Width, Clear	4' min.	A
Depth, Clear	3' min.	B
Height, Clear	8' min.	C
Stories	1 story max.	
Finish Level above Sidewalk	12" min.	D
Depth of Recessed Entries	8' max.	E

3. Miscellaneous

- Stairs may be perpendicular or parallel to the building facade.
- Entry doors shall be covered or recessed to provide shelter from the elements.
- Gates are not allowed.
- All doors shall face the street.
- The Stoop is allowed to encroach into the front and side street setbacks in compliance with Subsection 6 of the zone.
- Ramps are required to be integrated along the side of the building to connect with the Stoop.
- The Stoop shall be designed in compliance with the standards in Chapter 7 (Specific to Architectural Design) for the selected architectural style.

06.080 Forecourt



Example of a Forecourt with Shopfronts



Example of a Forecourt with outdoor dining



Example of Forecourt

1. Description

The main facade of the building is at or near the front design site line and a portion is set back, extending the public realm into the design site to create an entry court or shared garden space for housing, or an additional shopping or restaurant seating area within retail and service areas.

General Note: Photos on this page are illustrative, not regulatory.

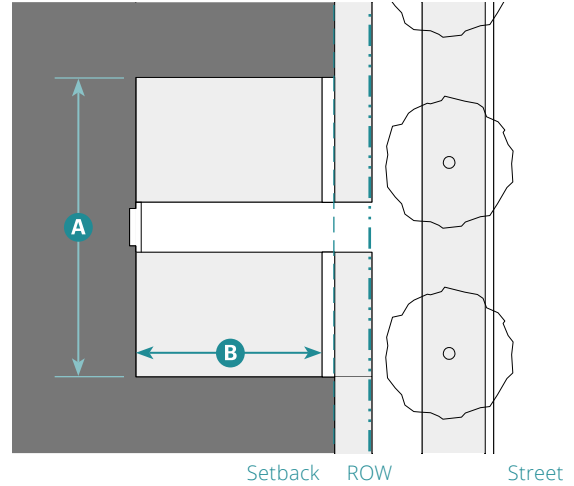
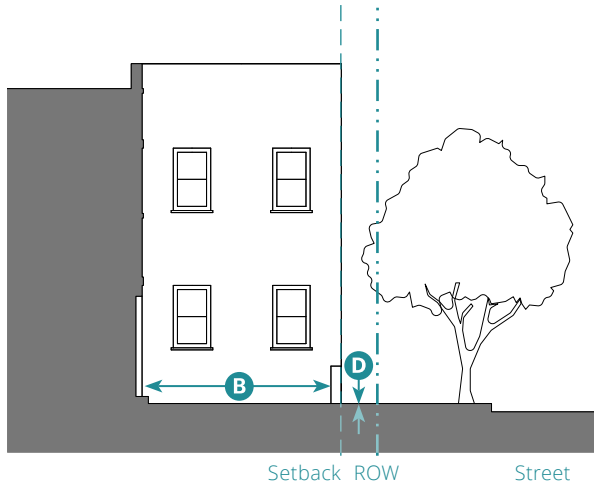

Key

--- ROW/ Design Site Line Setback Line

2. Size

Width, Clear	15' min.	A
Depth, Clear	15' min.	B
Ratio, Height to Width	2:1 max.	C
Finish Level above Sidewalk	12" max.	D
Gallery frontages, awnings, balconies and porches may encroach into Forecourt on all sides.	Max 1/2 width of Forecourt	E

3. Miscellaneous

Forecourts may be utilized to group several entries at a common elevation in compliance with the zones' ground floor finish level standards.

The proportions and orientation of a Forecourt shall be in compliance with the diagram below for solar orientation and user comfort.

Ramps are required to be integrated along the side of the building to connect with the Forecourt.

The Forecourt shall be designed in compliance with the standards in Chapter 7 (Specific to Architectural Design) for the selected architectural style.

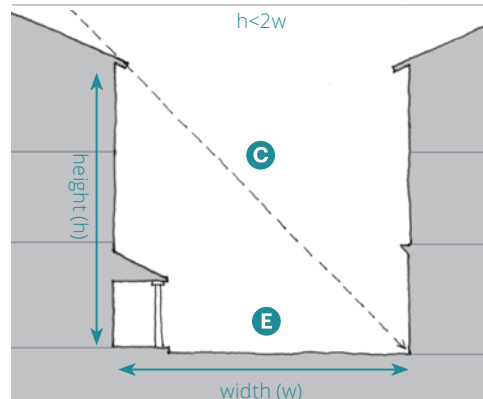

06.090 Maker Shopfront



Example of a Maker Shopfront



Example of a Maker Shopfront



Example of a Maker Shopfront

1. Description

The main facade of the building is at or near the front design site line with an at-grade or elevated entrance from the sidewalk. The type is only allowed on side streets from the adjacent main street and is intended for industrial artisan businesses to show their activity to pedestrians, as well as for retail sales of products made on-site. The Maker Shopfront may include a decorative roll-down or sliding door, including glazing and an awning that overlaps the sidewalk.

General Note: Photos on this page are illustrative, not regulatory.

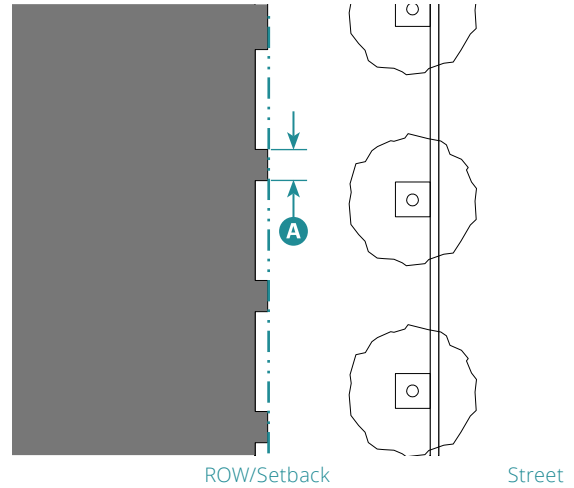
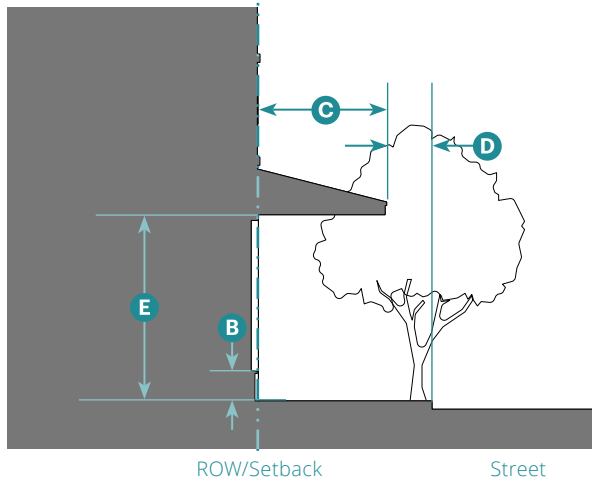

Key

--- ROW/ Design Site Line - - - - - Setback Line

2. Size

Distance between Glazing	10' max.	A
Ground Floor Glazing between Sidewalk and Finished Ceiling Height	30% min.	
Depth of Recessed Entries	No max.	
Shopfront Base (if used)	48" max.	B

3. Awning

Depth	5' min.	C
Setback from Curb	2' min.	D
Height, Clear	8' min.	E

4. Miscellaneous

Decorative accordion-style doors/windows or other operable windows that allow the space to open to the street are allowed in compliance with Chapter 7 (Specific to Architectural Design).

The Maker Shopfront shall be designed in compliance with the standards in Chapter 7 (Specific to Architectural Design) for the selected architectural style.

06.100 Shopfront



Example of Shopfronts



Example of a Shopfront



Example of a Shopfront

1. Description

The main facade of the building is at or near the front design site line with at-grade entrance from the sidewalk. The type is intended for service, retail, or restaurant use and includes substantial glazing between the Shopfront base and the ground floor ceiling. This type may include an awning that overlaps the sidewalk.

General Note: Photos on this page are illustrative, not regulatory.

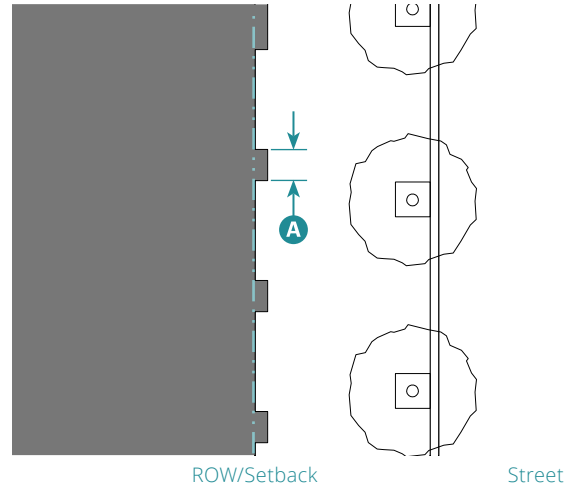
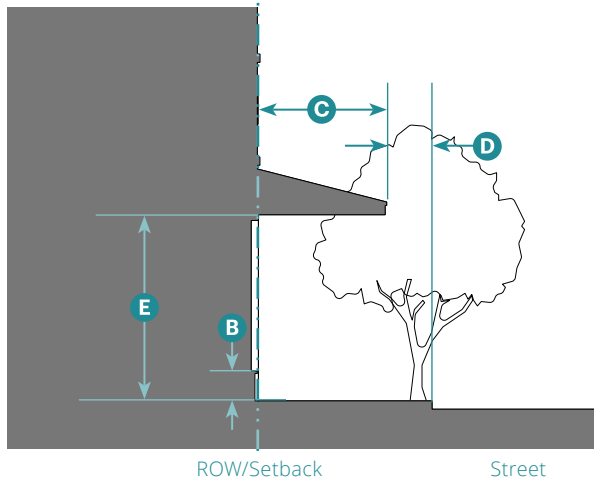

Key

--- ROW/ Design Site Line - - - - - Setback Line

2. Size

Distance between Glazing	2' max.	A
Ground Floor Glazing between Sidewalk and Finished Ceiling Height	75% min.	
Depth of Recessed Entries	5' max.	
Shopfront Base	6" min.; 24" max.	B

3. Awning

Depth	5' min.	C
Setback from Curb	2' min.	D
Height, Clear	8' min.	E

4. Miscellaneous

Decorative accordion-style doors/windows or other operable windows that allow the space to open to the street are allowed in compliance with Chapter 7 (Specific to Architectural Design).

Ramps are required to be integrated along the side of the building to connect with the Shopfront.

The Shopfront shall be designed in compliance with the standards in Chapter 7 (Specific to Architectural Design) for the selected architectural style.

06.110 Terrace



Example of a Terrace with low-wall seating



Example of a Terrace



Example of a residential Terrace along a courtyard

1. Description

The main facade is at or near the front design site line with steps leading to an elevated area providing pedestrian circulation along the facade. The type is used for retail, service, office uses, or housing to provide outdoor areas along the sidewalk and/or to accommodate an existing or intended grade change.

General Note: Photos on this page are illustrative, not regulatory.

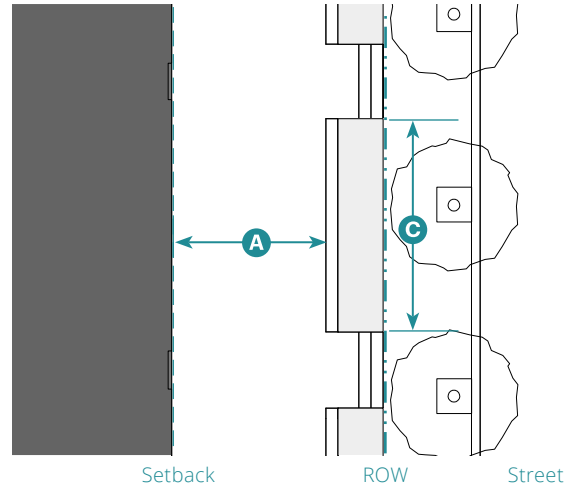
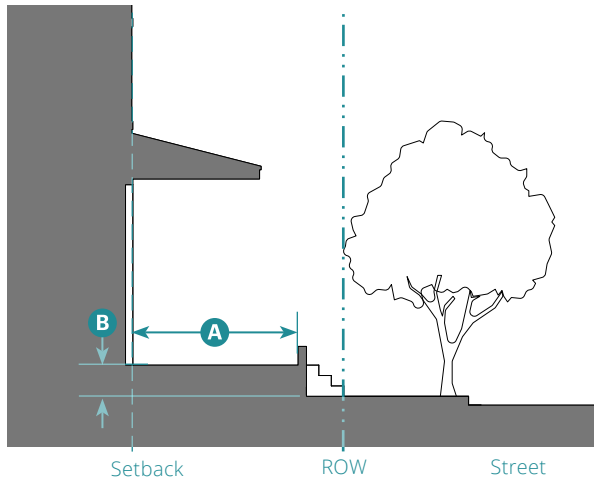

Key

--- ROW/ Design Site Line - - - - - Setback Line

2. Size		
Depth of Terrace	8' min. residential; 10' min. non-residential	A
Finish Level above Sidewalk	36" max.	B
Distance between Stairs	25' max.	C

3. Miscellaneous

These standards are to be used with those for the Shopfront Frontage Type where the zone requires the Shopfront Frontage Type (06.100).

Where the zone requires the Shopfront Frontage Type (06.100) and the ground floor is flush with the sidewalk, the Terrace shall be considered to be the sidewalk.

May be utilized to group several entries at a common elevation in compliance with the zones' ground floor finish level standards.

The Terrace is allowed to encroach into the front and side street setbacks in compliance with Subsection 6 of the zone. Ramps are required to be integrated along the side of the building to connect with the Terrace.

The Terrace shall be designed in compliance with the standards in Chapter 7 (Specific to Architectural Design) for the selected architectural style.

06.120 Gallery



Source: Google Street View

Example of a two-story Gallery with an uncovered second story.



Example of a Gallery providing covered outdoor dining



Example of a Gallery with shopfronts

1. Description

The main facade of the building is set back from the front design site line and an at-grade covered structure, articulated with colonnade or arches, overlaps the sidewalk. The type may be one or two stories. When used in nonresidential settings, the Shopfront Type is included; when used in residential settings, Stoops, Dooryards, and Forecourts may be included as allowed by the zone.

General Note: Photos on this page are illustrative, not regulatory.

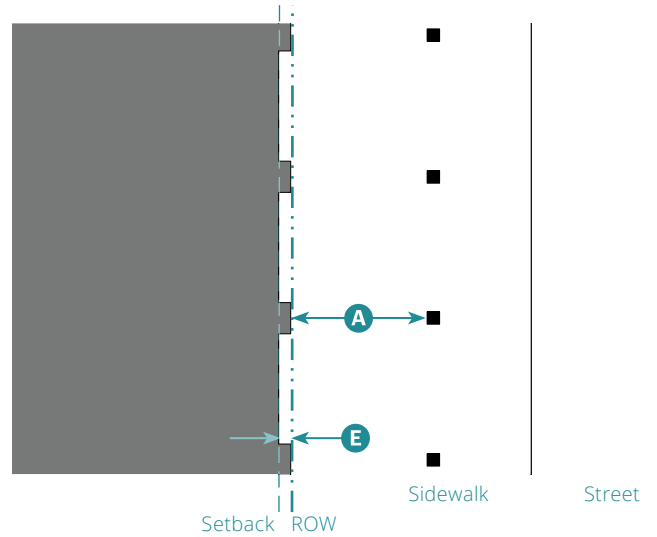
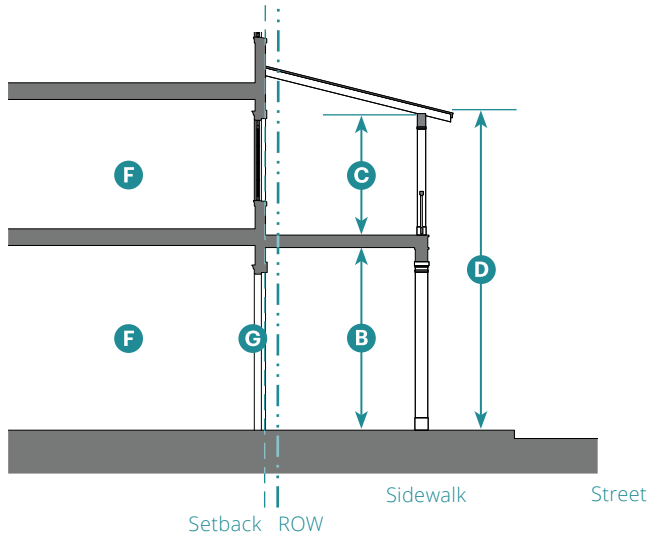

Key

--- ROW/ Design Site Line - - - - - Setback Line

2. Size		
Depth, Clear	8' min.	A
Ground Floor Height, Clear	12' min.	B
Upper Floor Height, Clear	9' min.	C
Height	2 stories max.	D
Gallery Setback from Public ROW	18" min. (clear)	E

- | 3. Miscellaneous | |
|--|----------|
| Habitable space | F |
| Galleries shall also follow the standards for the Shopfront Frontage Type (06.100). | G |
| Galleries shall have a consistent depth across the entire front and/or side street facade. | |
| Galleries are allowed to project over the sidewalk in the public ROW. | |
| The second story of the Gallery may be covered. | |
| Planting is not required. | |
| Lighting is required within the gallery. | |
| Ramps are required to be integrated along the side of the building to connect with the Gallery, where applicable. | |
| The Gallery shall be designed in compliance with the standards in Chapter 7 (Specific to Architectural Design) for the selected architectural style. | |

This page intentionally left blank

Chapter 7: Specific to Architectural Design

Sections:

07.010	Purpose
07.020	Applicability
07.030	Architectural Design Standards
07.040	Overview of Architectural Styles
07.050	Contemporary
07.060	Craftsman
07.070	Main Street Classical
07.080	Mediterranean
07.090	Tudor
07.100	Victorian

07.010 Purpose

This Chapter sets forth standards that supplement the zone standards to further refine the intended building form and physical character.

07.020 Applicability

Unless stated otherwise, all subsections within each architectural style ("style") identified in this Chapter apply to all facades of a building, including front facades, side street facades, side interior facades, and rear facades.

07.030 Architectural Design Standards

This Chapter contains architectural design standards for the six allowed styles. The standards for each style address a range of topics based on local architectural examples. The standards address the following aspects of individual building design: Roofs and roof pitch, eaves, cornices, walls, base of walls, dormers, openings and doors, storefronts, porches, and balconies.

1. Each building is required to be designed in compliance with one of the allowed architectural styles.
2. The architectural style standards are coordinated with the building types allowed by this FBC and the intended physical character of each zone.
3. Any facade greater than 75 feet in length along a street (public or private) or civic space shall include more than one architectural style, with a maximum 75 feet in length of any one style.

07.040 Overview of Architectural Styles

Table A (Architectural Styles Overview) provides an overview of the allowed architectural styles.

Table 07.040.A: Architectural Styles Overview

Contemporary 07.050



Typical Characteristics

Long, low-sloped roof forms with simple eaves with deep overhangs
 Asymmetrical facade compositions with square and horizontal openings often made from ganged vertical windows
 Mix of exterior materials to differentiate massing forms, with prevalent natural materials including wood siding
 Horizontally proportioned balconies and terraces with minimalist vertical supports

Applicable Standards

- Wall
- Building Roof
- Rake
- Eave
- Parapet
- Windows
- Bay Windows
- Dormers
- Entry Doors
- Balconies
- Porches
- Storefronts
- Materials

Craftsman 07.060



Typical Characteristics

Low-pitched roofs with deep eaves and exposed rafter tails
 Horizontally proportioned openings made from ganged vertical windows
 Emphasis on natural materials including wood shingles
 Asymmetrical composition with wall plane broken by projecting gable ends

Applicable Standards

- Wall
- Base
- Building Roof
- Rake
- Eave
- Parapet
- Windows
- Bay Windows
- Dormers
- Entry Doors
- Balconies
- Porches
- Storefronts
- Materials

Main Street Classical 07.070



Typical Characteristics

Symmetrical facade composition with proportions that imply load-bearing masonry structure
 Prominent cornice with classical detailing and parapet or pedimented roof forms
 Regular pattern of vertically proportioned openings
 Brick and stucco as primary facade materials

Applicable Standards

- Base
- Building Roof
- Parapet
- Windows
- Bay Windows
- Entry Doors
- Balconies
- Porches
- Storefronts
- Materials

Table 07.040.A: Architectural Styles Overview (Continued)

Mediterranean 07.080



Typical Characteristics

Low-pitched gabled or hipped roofs clad in red tile with open eaves
 Flat, rectilinear wall plane with vertically proportioned punched openings without trim
 Stucco as primary facade material with stucco or wood attached elements

Applicable Standards

- Building Roof
- Eave
- Parapet
- Windows
- Bay Windows
- Dormers
- Entry Doors
- Balconies
- Porches
- Storefronts
- Materials

Tudor 07.090



Typical Characteristics

Prominent gabled roof forms with steep pitch and open eaves
 Vertically proportioned openings with surround
 Brick and stucco as primary facade materials, often with half-timbering at upper floors

Applicable Standards

- Wall
- Building Roof
- Rake
- Eave
- Windows
- Bay Windows
- Dormers
- Entry Doors
- Balconies
- Porches
- Storefronts
- Materials

Victorian 07.100



Typical Characteristics

Simple, rectilinear forms articulated with a regular pattern of openings
 Vertically proportioned elements, including steeply pitched roofs, projecting gable ends, and tall cornices and parapets
 Vertically proportioned windows, angled or boxed bays, and picture windows
 Siding or stucco with shingled elements

Applicable Standards

- Wall
- Base
- Building Roof
- Rake
- Eave
- Parapet
- Windows
- Bay Windows
- Dormers
- Entry Doors
- Balconies
- Porches
- Storefronts
- Materials

Quick Code Guide: Specific to Architectural Design

The following graphic is intended as a summary guide.

Before you begin
Identify your zone, building type, and detailed massing type. If you have not done this yet, go back to the Table of Contents and follow the Quick Code Guide.

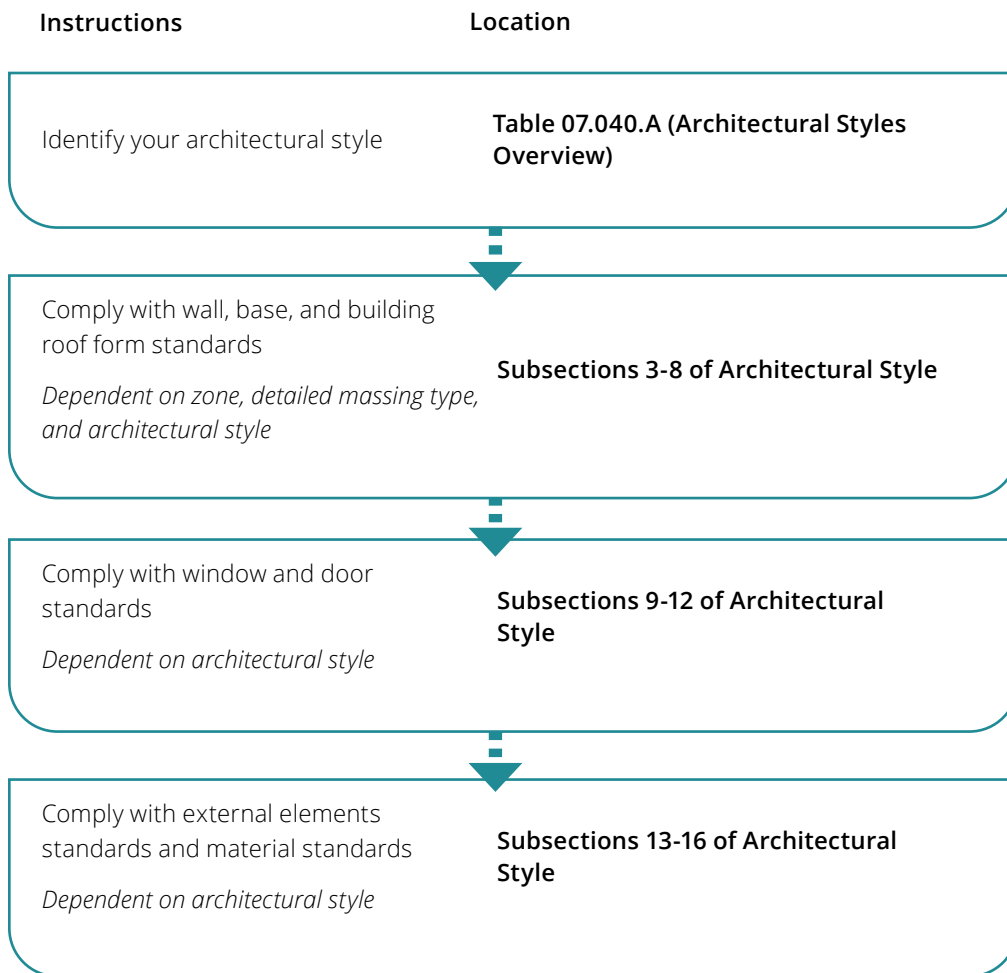



General note: The images above and the descriptions in Subsections 1 and 2 below are intended to provide a brief overview of the architectural style and are descriptive, not regulatory.

1. Description of Style

Contemporary style buildings have a streamlined aesthetic and minimal ornamentation. This style focuses on combining simple rectilinear massing forms with changes in material and color. The use of glass and cantilevered elements imbues buildings with a sense of lightness and simplicity. This style is prevalent throughout Marin County.

2. Typical Characteristics

Long, low-sloped roof forms with simple eaves with deep overhangs

Asymmetrical facade compositions with square and horizontal openings often made from ganged vertical windows

Mix of exterior materials to differentiate massing forms, with prevalent natural materials including wood siding

Horizontally proportioned balconies and terraces with minimalist vertical supports

Elements of Contemporary Style – Multifamily Prototype

Note: The image below is intended to provide a reference for architectural elements and is illustrative, not regulatory. It is not an exhaustive list of applicable standards.

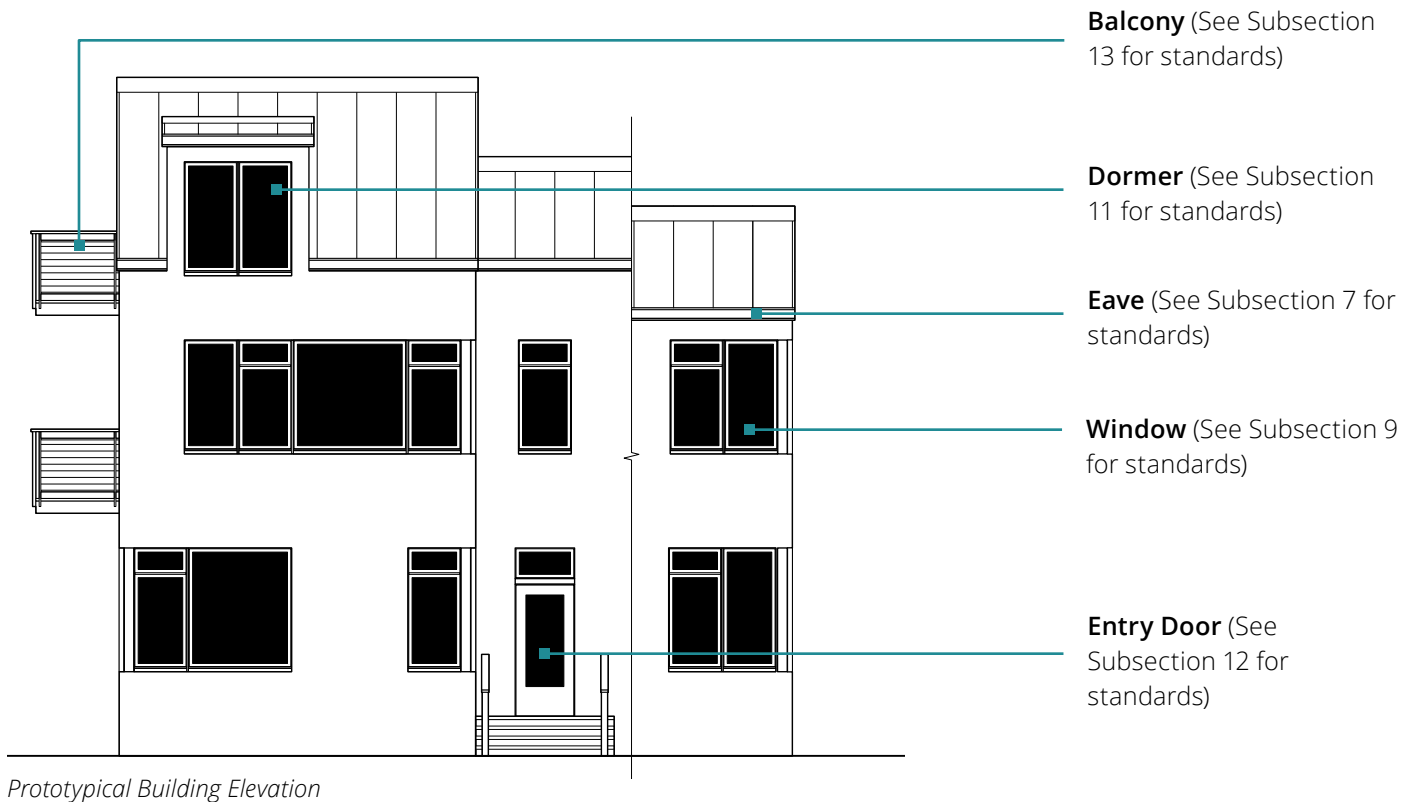

Elements of Contemporary Style – Mixed-Use Prototype

Note: The image below is intended to provide a reference for architectural elements and is illustrative, not regulatory. It is not an exhaustive list of applicable standards.

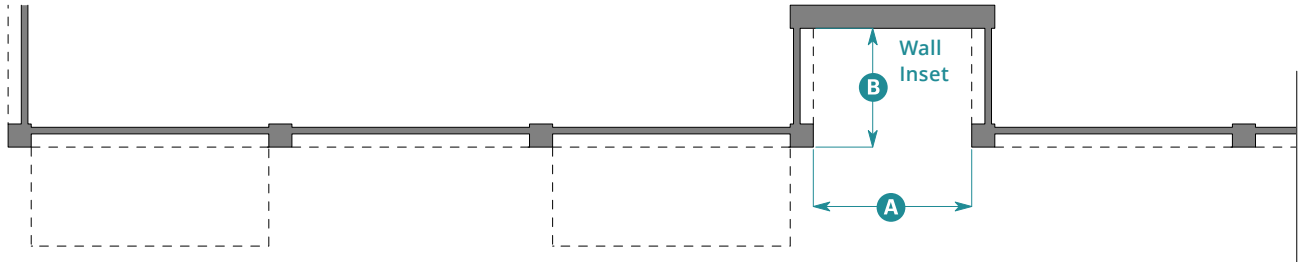

Prototypical Building Plan, Primary Facade



Prototypical Building Elevation

3. Wall

Wall Inset

A wall inset from the primary facade is required for buildings greater than 75' in width.

Wall inset shall be continuous for the full height of the building.

Roof and wall projections may encroach into wall inset.

3. Wall (Continued)

Wall Inset Dimensions

Width 8'0" min.; 12'0" max. A

Depth 6'0" min. B

4. Base

No base is required for this style.

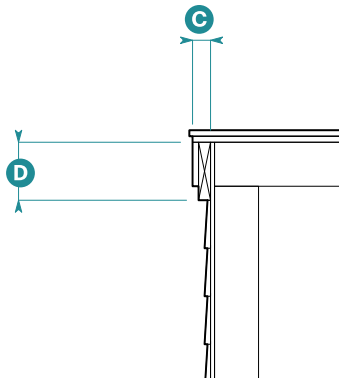

Flush Profile Rake Section

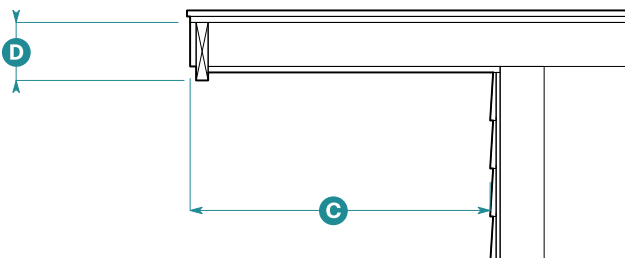

Projecting Profile Rake Section

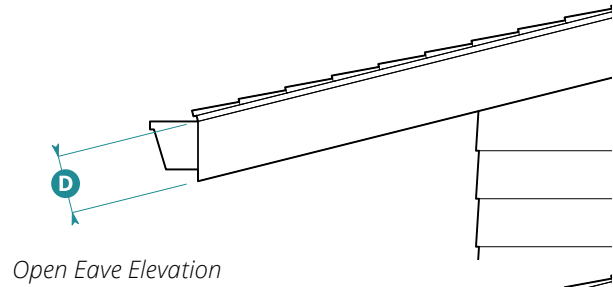

Open Eave Elevation

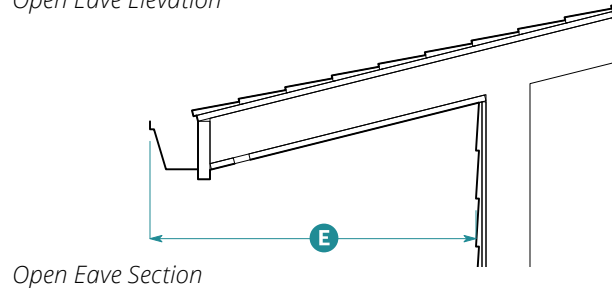

Open Eave Section

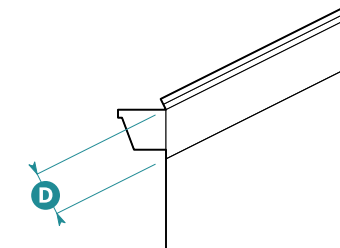

Closed Eave Elevation

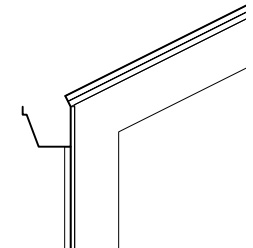

Closed Eave Section

5. Building Roof

Building Roof Standards	Buildings with Half-Story Heights	Buildings with Full-Story Heights
-------------------------	-----------------------------------	-----------------------------------

Roof Form		
Type	Shed	Flat
Pitch	2:12 min.; 6:12 max.	N/A

Applicable Subsections

6. Rake	A	N/A
7. Eave	A	N/A
8. Parapet	N/A	A

6. Rake

Standards	Flush Profile	Projecting Profile
Horizontal Projection	No min.; 2" max.	2'6" min.; No max.

See Subsection 7 (Eave) for height standards.

7. Eave

Standards	Open	Closed
-----------	------	--------

Height		
Fascia	6" min.	6" min.

Horizontal Projection

Overall	36" min.; No max.	N/A
---------	----------------------	-----

A = Applicable N/A = Not Applicable

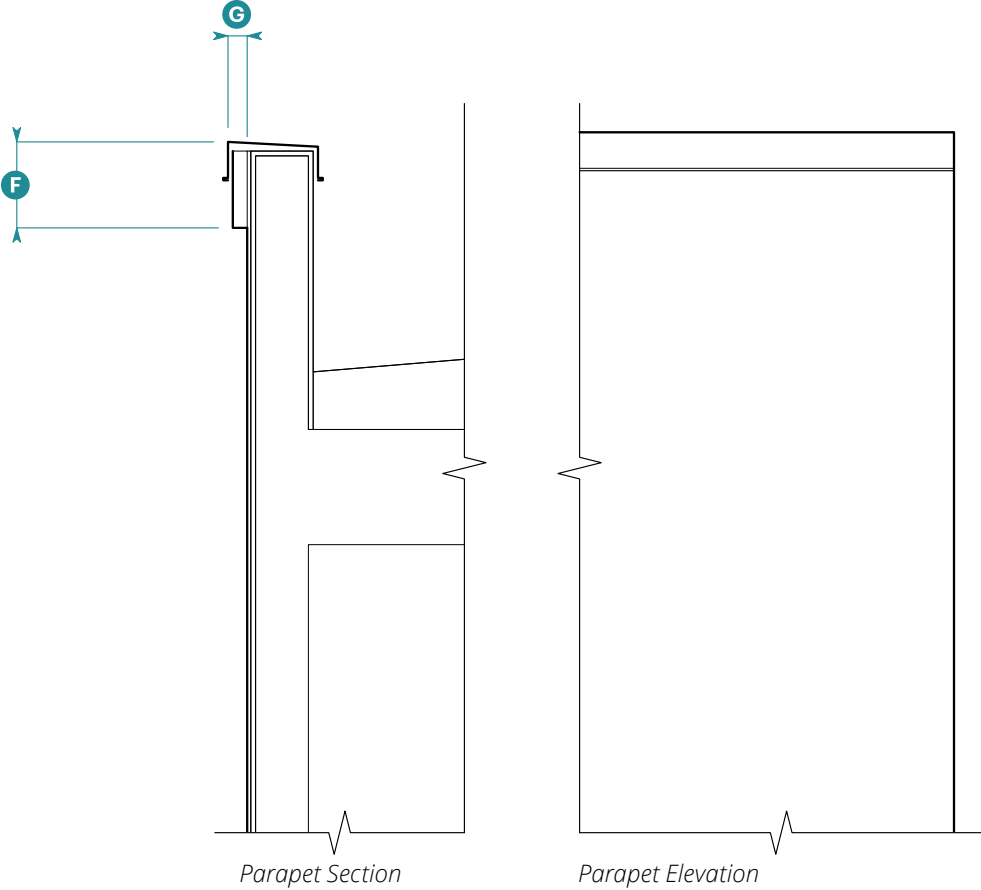

8. Parapet

Height

Projection 0" min.; 6" max. **F**

Horizontal Projection

Overall 0" min.; 3" max. **G**

9. Windows

Opening

Proportion, Height **H** to Width **I** ¹

Ground floor	2.2 min.
Upper floor	2.0 min.
Dormer	See Subsection 11 (Dormers) for standards.

Typical Sizes, Width **I** x Height **H**

Ground Floor, Typical	3'0" x 6'0"
Ground Floor, Ganged	3'0" x 6'0"
Ground Floor, Picture	4'6" x 6'0"
Upper Floor, Typical	3'0" x 5'6"
Upper Floor, Ganged	3'0" x 5'6"
Upper Floor, Picture	4'6" x 5'6"
Privacy	2'0" x 4'6"

Shape	Square
-------	--------

Operation	Double-Hung, Single-Hung, Awning, Casement
-----------	---

Window

Glazing Divisions	None
-------------------	------

Frame Width (Frame + Sash)

At Rail	2.5" min. ± 1/4"	J
At Stile	2.5" min. ± 1/4"	K

Trim Widths ²

Head	3" min.
Jamb	3" min.
Apron	3" min.

Window Frame Recess

Depth	2" min.
-------	---------

Sill

Depth	3" min.
-------	---------

Pediment

Allowed	No
---------	----

Mullions

Mullions required between ganged windows.

"Typical" refers to a regular recurring window (i.e., size or lite pattern) on a facade.

¹ Picture windows shall be wider than typical windows and equal in height to windows on the same floor.

² Trim required for windows only on buildings or parts of buildings with lap siding.

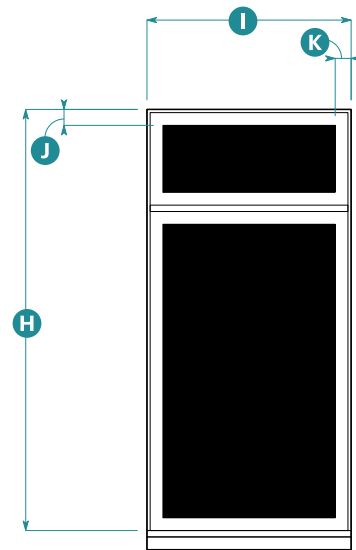

Upper Floor Typical Window Elevation

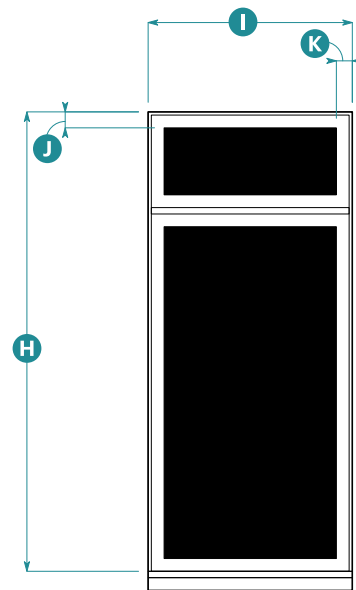

Ground Floor Typical Window Elevation

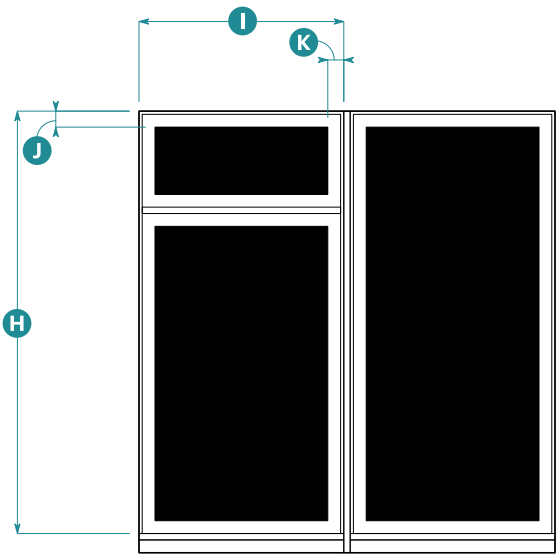

Upper Floor Ganged Window Elevation

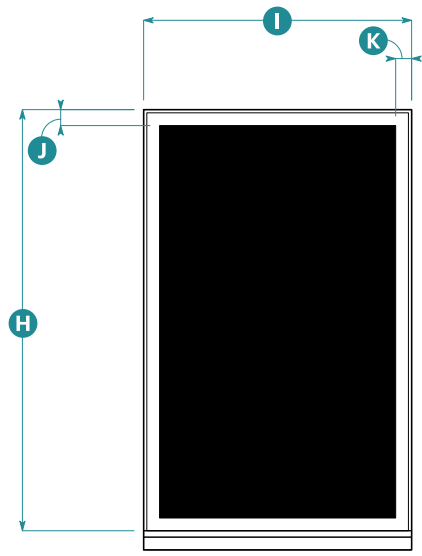

Upper Floor Picture Window Elevation

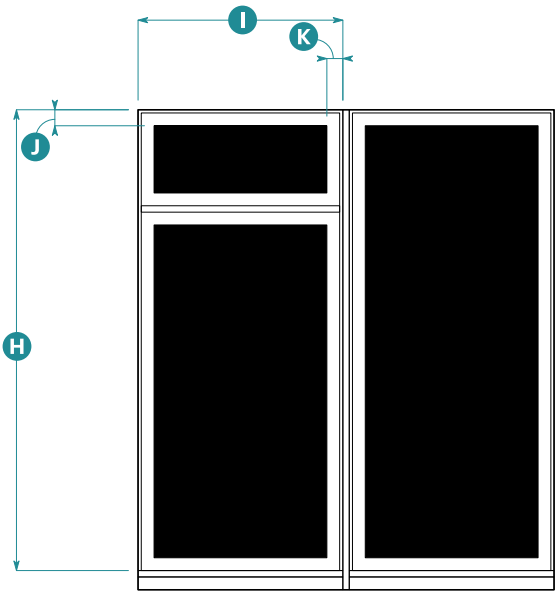

Ground Floor Ganged Window Elevation

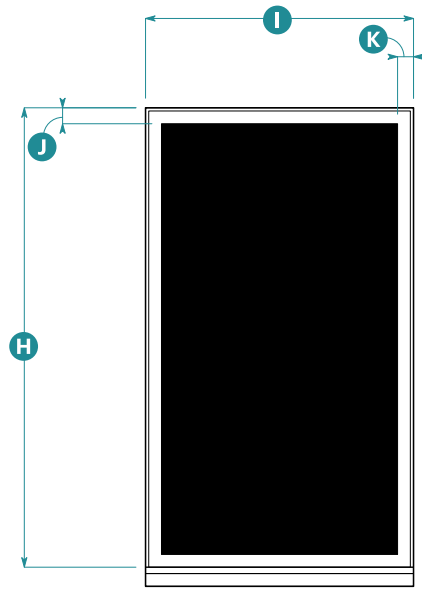

Ground Floor Picture Window Elevation



Bay Window Plan

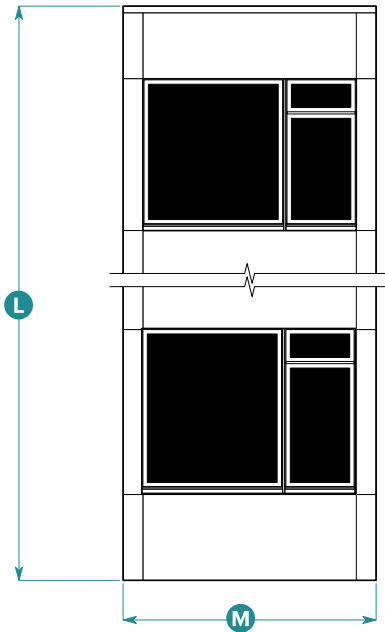

Bay Window Elevation

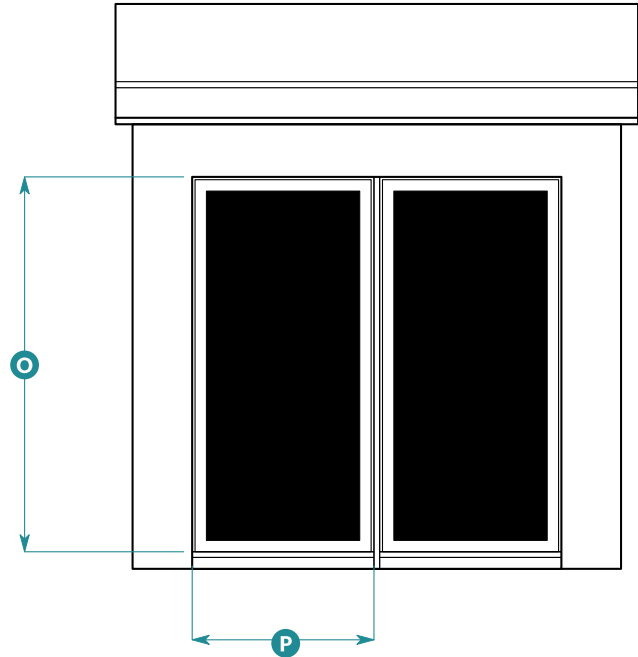

Dormer Elevation

10. Bay Windows

Form

Type Square

Size

Height L

On buildings with heights up to 3 stories 2 stories max.

On buildings with heights above 3 stories 2 stories plus 1 additional story for each building story over 3 max.

Width 6'0" min.; 12'0" max. M

Depth 1'0" min.; 3'0" max. N

Additional Standards

Multi-story bay window form shall be vertically continuous. Continuous horizontal articulation on building shall wrap bay form.

Corner bay may be turned on side to be rotated 45 degrees from building corner.

11. Dormers

Roof Form

Type Shed

Pitch 2:12 min.; 6:12 max.

Window

Proportion, Height to Width O P 2.0 min.

Width P 3'0" min.

Dormers allowed only for buildings with half stories. See Subsections 6 (Rake), 7 (Eave), and 9 (Windows) for additional standards.

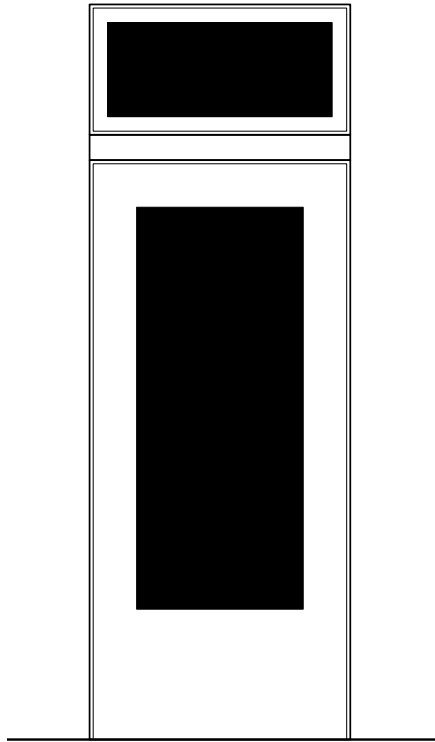

Entry Door Elevation

12. Entry Doors	
Surround ³	
Head Width	4" min.
Jamb Width	4" min.
Additional Elements	
Transom	Allowed
Pediment	Not Allowed

³Surround required for doors only on buildings or parts of buildings with lap siding.

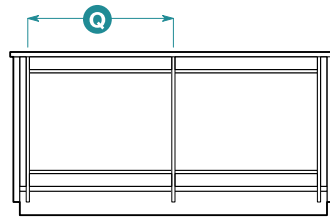

Type 1
Panel Guardrail

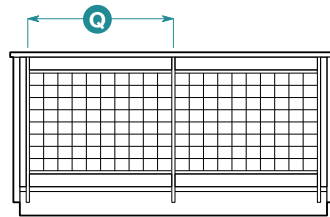

Type 2
Mesh Guardrail

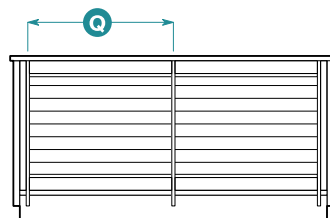

Type 3
Horizontal Guardrail

Balcony Front Elevation

13. Balconies	
Allowed Materials	
Type 1 - Panel Guardrail	
Post	Metal
Baluster	Metal panel
Handrail	Metal, glass
Fascia	Metal, composite wood, wood
Type 2 - Mesh Guardrail	
Post and Handrail	Metal
Baluster	Metal mesh
Fascia	Metal, composite wood, wood
Type 3 - Horizontal Guardrail	
Post and Handrail	Metal
Baluster	Metal, steel cable
Fascia	Metal, composite wood, wood
Size	
Overall Balcony Width	10'0" max.
Width Between Posts	3' min.



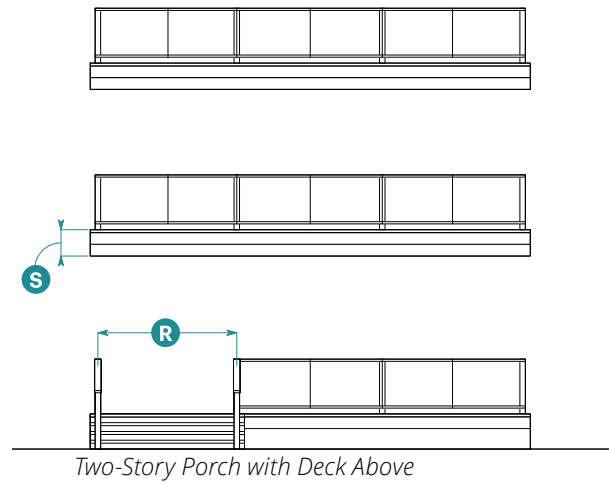
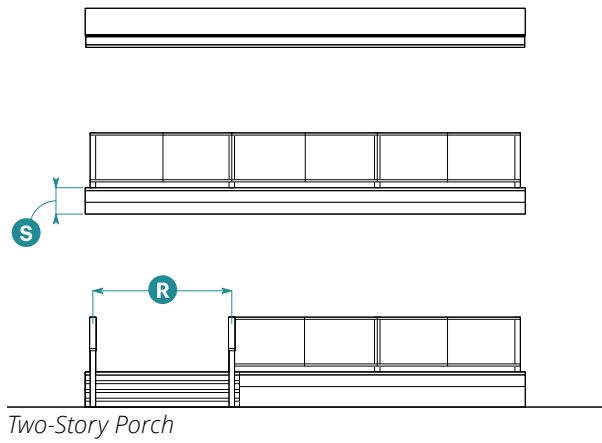
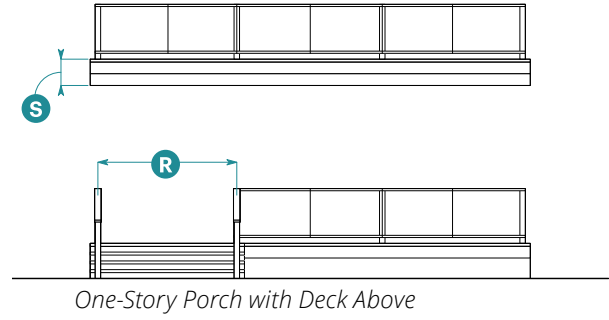
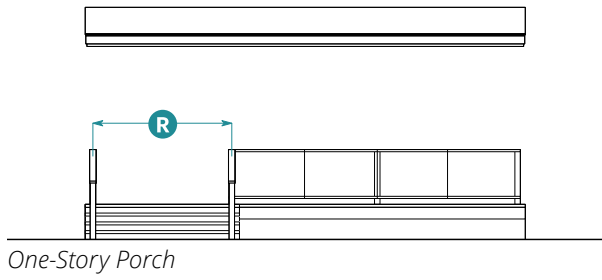

14. Porches	
Columns	
Shape	Cantilevered (no columns) or Pilotis
Diameter	4" max.
Spacing	8'0" max. on center R
Entablature	
Height of Entablature Supporting Deck	
Overall	10" min. S

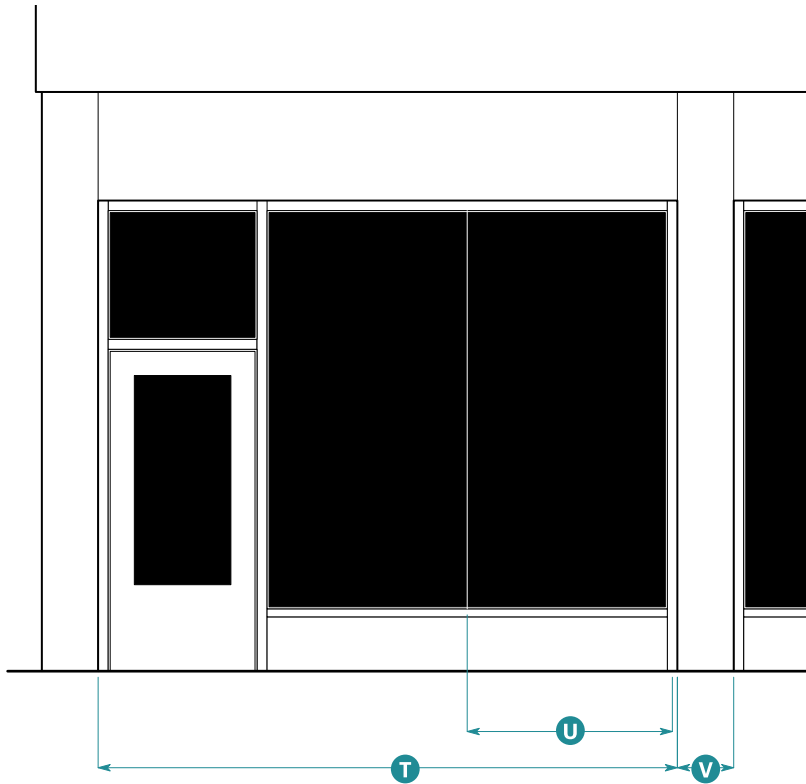

Storefront Elevation

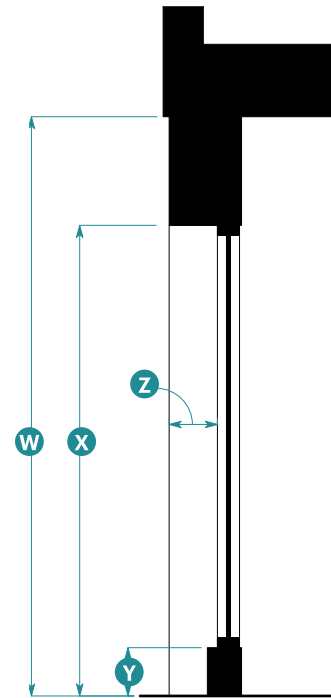

Storefront Section

15. Storefronts

Width

Storefront Module	10'0" min.; 15'0" max.	T
Display Window	3'0" min.; 4'0" max.	U
Distance Between Storefront Modules	1'0" min.; 2'0" max.	V

Height

Overall	12'0" min.	W
Head Height	11'0" min.	X
Base	8" min.; 2'0" max.	Y

Horizontal Recess

Depth	6" min.; 3'0" max.	Z
-------	--------------------	---

Base shall be continuous, unless divided by pilaster, and align with base height of building (if any).

16. Materials	
Element	Allowed Materials
Wall	
Wall Cladding	Lap siding, composite wood, wood, fiber cement, stucco, metal panel
Base or Foundation	
Base or Foundation	Brick, concrete, stone, stucco, composite wood, wood, fiber cement
Roof and Roof Elements	
Roofing	Asphalt shingles, wood shingles, standing seam metal
Rake and Eave	Composite wood, wood, steel
Gutter	Metal box
Windows, Bay Windows, and Entry Doors	
Entry Door	Wood, aluminum, fiberglass, composite wood
Window Frames	Wood, aluminum clad wood, aluminum, fiberglass
Glazing	Clear glass; shall not be tinted, mirrored, or colored
Balconies	
See Subsection 13 (Balconies) for allowed materials.	
Porches	
Columns	Composite wood, wood, fiberglass, metal
Railing	Composite wood, wood, metal
Storefronts	
Storefront	Composite wood, wood, metal
Storefront Base	Stucco, concrete



General note: The images above and the descriptions in Subsections 1 and 2 below are intended to provide a brief overview of the architectural style and are descriptive, not regulatory.

1. Description of Style

The Craftsman style emerged in the American west inspired by the English Arts and Crafts movement. The Craftsman bungalow house was prevalent from the 1900's to the 1940's. Since that time, it has adapted to multifamily and mixed-use prototypes.

2. Typical Characteristics

Low-pitched roofs with deep eaves and exposed rafter tails

Horizontally proportioned openings made from ganged vertical windows

Emphasis on natural materials including wood shingles

Asymmetrical composition with wall plane broken by projecting gable ends

Wall plane broken by projecting and/or recessed elements

Elements of Craftsman Style – Multifamily Prototype

Note: The image below is intended to provide a reference for architectural elements and is illustrative, not regulatory. It is not an exhaustive list of applicable standards.

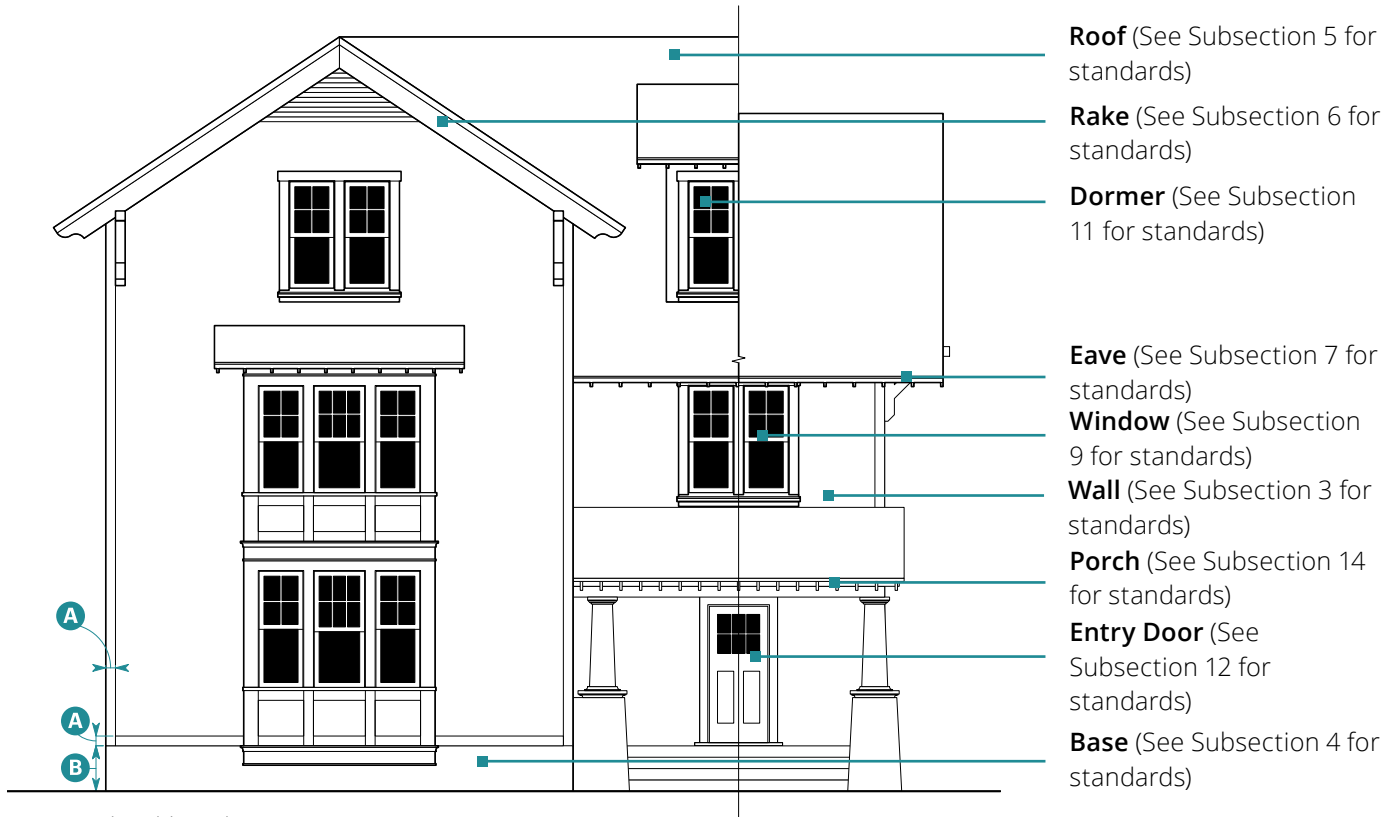

Prototypical Building Elevation

3. Wall	
Trim ¹	
Width	4" min. A

¹Trim not required on buildings or portions of buildings where stucco is the primary wall material.

4. Base	
Height	1'0" min.; 1/2 story max. B

Elements of Craftsman Style – Mixed-Use Prototype

Note: The image below is intended to provide a reference for architectural elements and is illustrative, not regulatory. It is not an exhaustive list of applicable standards.



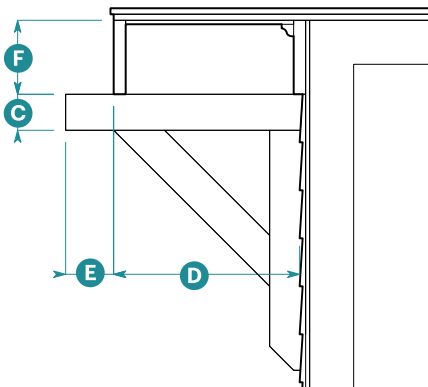

Rake Section

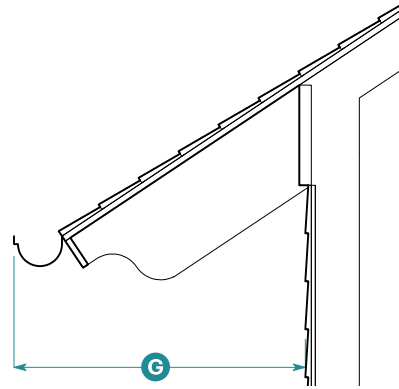

Eave Section

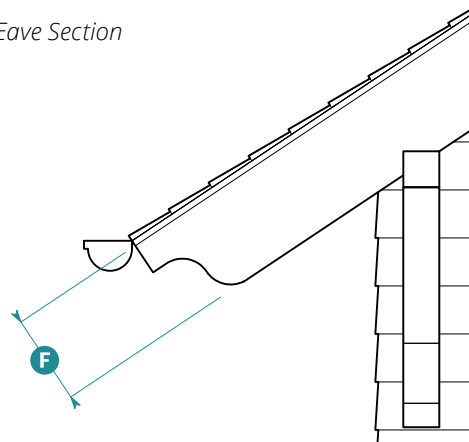

Eave Elevation

5. Building Roof		
Building Roof Standards	Sloped Roof	Flat Roof
Applicable Subsections		
Subsection 6 (Rake)	A	N/A
Subsection 7 (Eave)	A	N/A
Subsection 8 (Parapet)	N/A	A
Form		
Pitch	4:12 min.; 10:12 max.	N/A

6. Rake		
Height		
Bracket Bracing Member	4" min.	C
Horizontal Projection		
Projection to Fascia	1'8" min. 3'0" max;	D
Bracket Projection Beyond Fascia	No min.; 1'0" max.	E

See Subsection 7 (Eave) for height standards.

7. Eave		
Allowed Types		
Eave Types	Open	
Height		
Fascia	10" min.	F
Horizontal Projection²		
Overall	2'6" min.	G

²Horizontal projection includes gutter.

A = Applicable N/A = Not Applicable

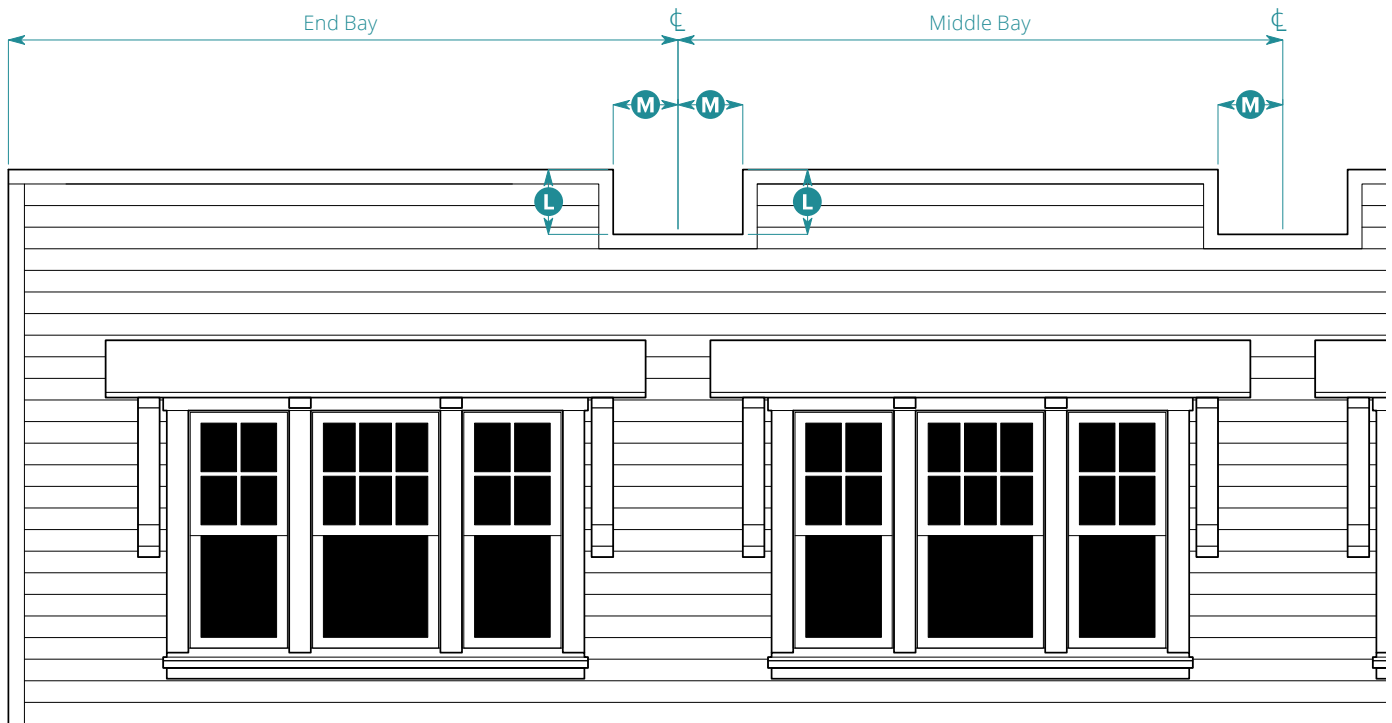

8. Parapet

Canopy

Parapet may include canopy.

Eave Height 6" min. (H)

Horizontal Projection³ 3'0" min. (I)

Required Support Brackets
Elements

Bracket Width 4" min. (J)

Roof Pitch 3:12 min. (K)

Crenellation

Parapet shall be crenellated.

Crenel Height 1'0" min. (L)

Width, from Center 1'0" min. (M)

Line

Crenel may not occur at building corner or end bays.

³Horizontal projection includes gutter.

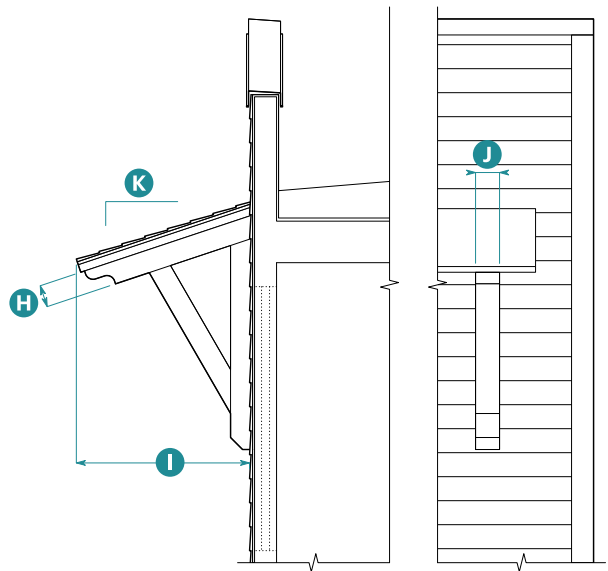

Parapet Section

Parapet Elevation

9. Windows

Opening

Proportion, Height **N** to Width **O**⁴

Ground Floor	2.0 min.
Upper Floor	1.75 min.
Dormer	See Subsection 11 (Dormers) for standards.

Typical Sizes, Width **O** x Height **N**

Ground Floor, Typical	3'0" x 6'0"
Ground Floor, Ganged	2'4" x 6'0"
Ground Floor, Picture	4'6" x 6'0"
Upper Floor, Typical	3'0" x 5'6"
Upper Floor, Ganged	2'4" x 5'6"
Upper Floor, Picture	4'6" x 5'6"
Privacy	2'0" x 4'0"

Shape	Square
Operation	Single Hung, Double Hung, Casement

Window

Glazing Divisions	6 over 1; 4 over 1; 10 over 1
-------------------	-------------------------------------

Frame Width (Frame + Sash)		
At Rail	2.5" min. ± 1/4"	P
At Stile	2.5" min. ± 1/4"	Q

Trim Widths		
Head	6" min.	R
Jamb	6" min.	S
Apron	3" min.	T

Window Frame Recess

Depth	2" min.
-------	---------

Sill

Depth	3" min.
-------	---------

Pediment

Allowed	No
---------	----

Mullions

Mullions required between ganged windows.

"Typical" refers to a regular recurring window (i.e., size or lite pattern) on a facade.

¹ Picture windows shall be wider than typical windows and equal in height to windows on the same floor.

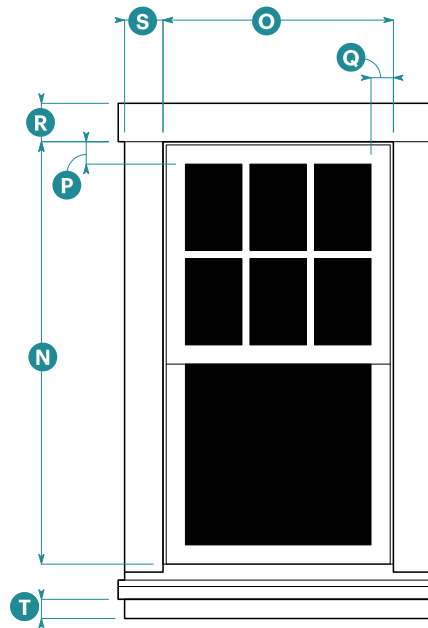

Upper Floor Typical Window Elevation
6 over 1

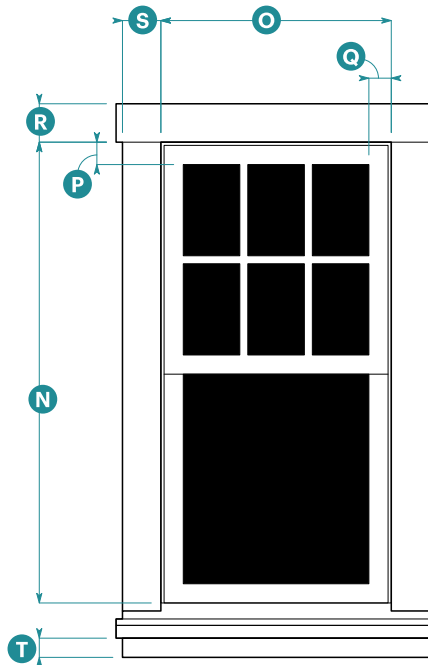

Ground Floor Typical Window Elevation
6 over 1

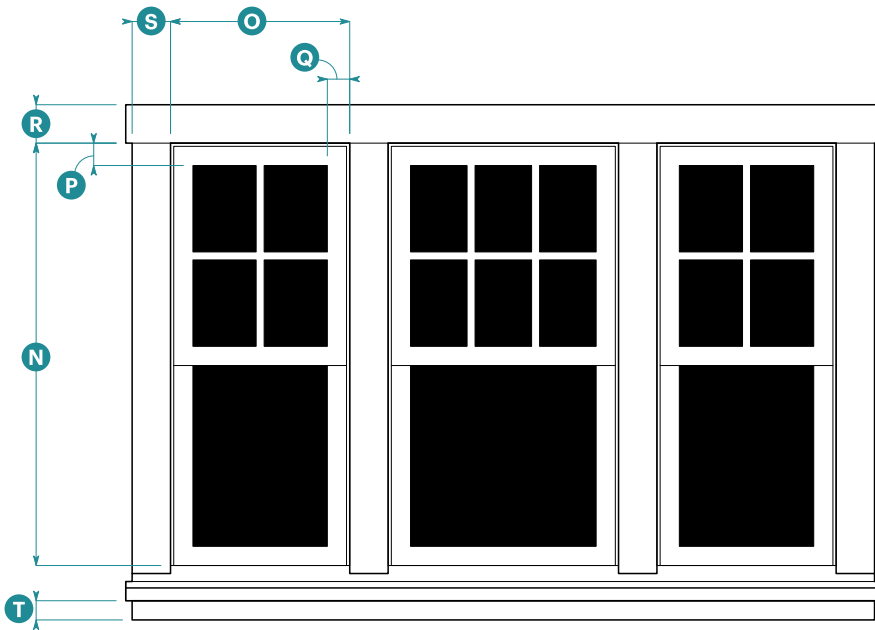

*Upper Floor Ganged Window Elevation
4 over 1 and 6 over 1*

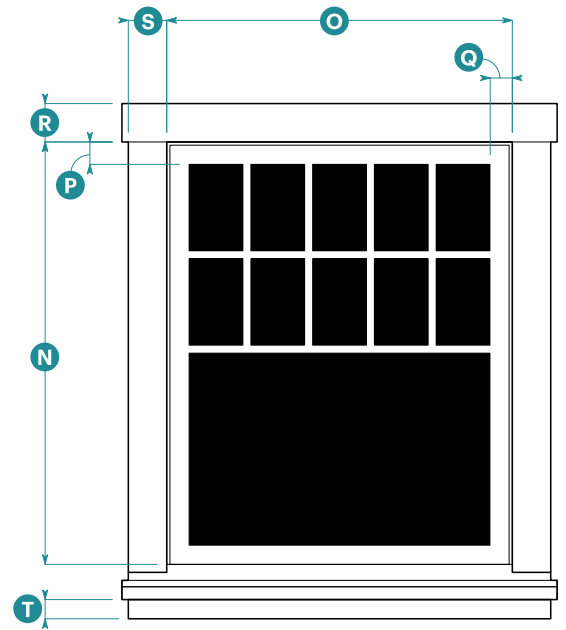

*Upper Floor Picture Window Elevation
10 over 1*

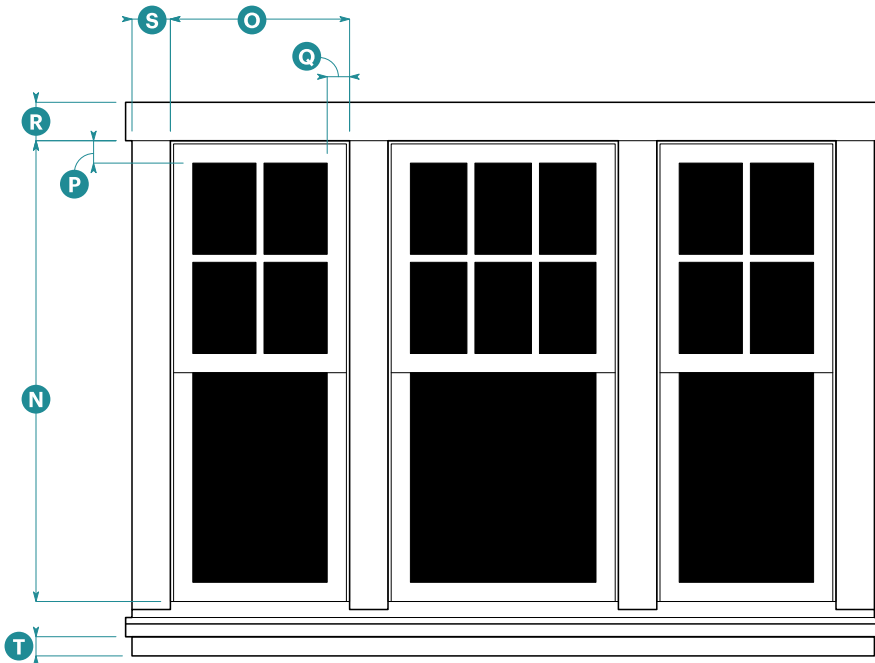

*Ground Floor Ganged Window Elevation
4 over 1 and 6 over 1*

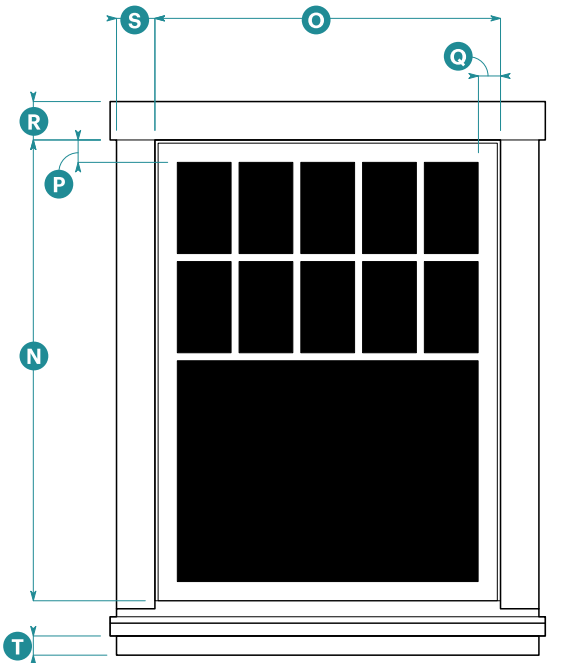

*Ground Floor Picture Window Elevation
10 over 1*



Bay Window Plan

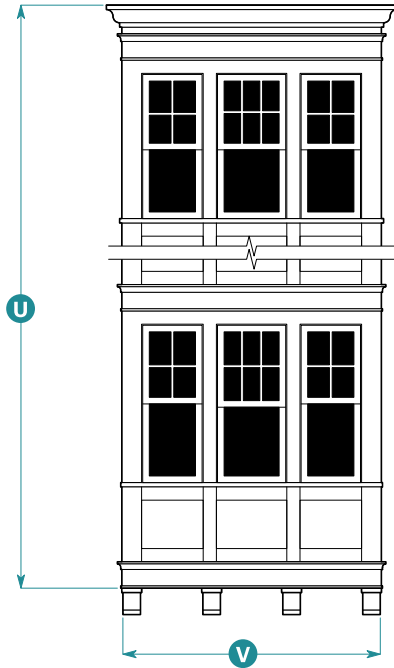

Bay Window Elevation

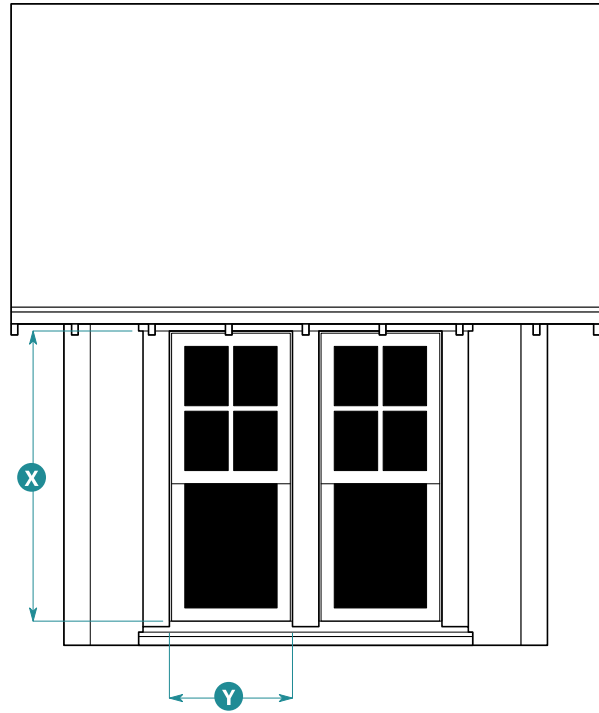

Dormer Elevation

10. Bay Windows

Form

Type Square

Size

Height U

- On buildings with heights up to 3 stories 2 stories max.
- On buildings with heights above 3 stories 2 stories plus 1 additional story for each building story over 3 max.

Width 6'0" min.; 12'0" max. V

Depth 1'0" min.; 3'0" max. W

Cornice Types

- Building parapet wraps bay.
- Bay stops below building eave (bay has own cornice).
- Bay returns into building eave (bay never projects above the building eave).

Additional Standards

- Bay depth not allowed to project beyond eave depth.
- Multi-story bay window form shall be vertically continuous.

10. Bay Windows (Continued)

Continuous horizontal articulation on building shall wrap bay form.

Corner bay may be turned on side to be rotated 45 degrees from building corner.

11. Dormers

Roof Form

Type Shed or Gable

Pitch 2:12 min.; 5:12 max.

Horizontal Projection

Eave 8" min.

Rake 8" min.

Window

Proportion, Height 1.75 min.
X to Width Y

Width 3'0" min. Y

Dormers allowed only for buildings with half stories.

Pediment not allowed.

See Subsections 6 (Rake), 7 (Eave), and 9 (Windows) for additional standards.

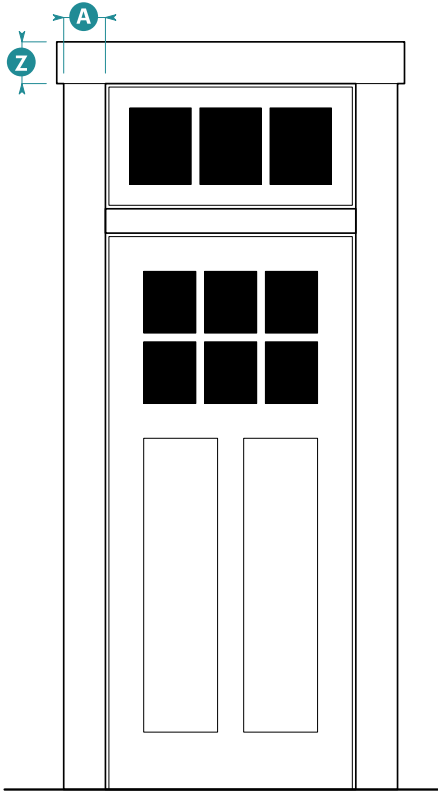

Entry Door Elevation

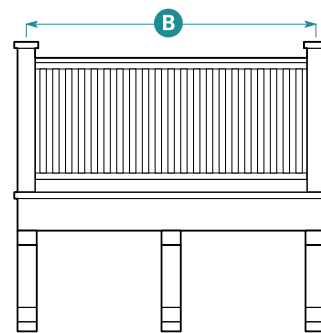

Balcony Front Elevation

12. Entry Doors

Door

Number of Panels 2 min.

Surround

Head Width 6" min. **Z**

Jamb Width 4" min. **A**

Additional Elements

Transom Allowed

Pediment Not Allowed

13. Balconies

Allowed Materials

Post, Baluster, Handrail, and Fascia Metal, composite wood, wood

Size

Overall Balcony Width 10'0" max.

Width Between Posts 3' min. **B**

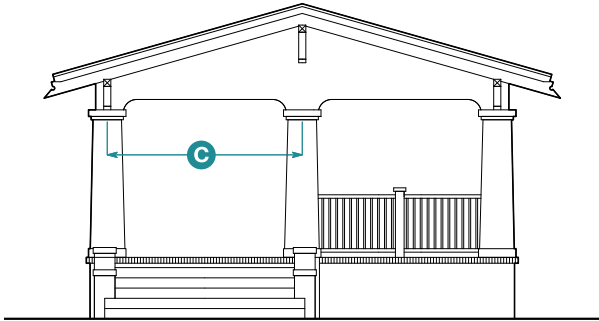

One-Story Porch

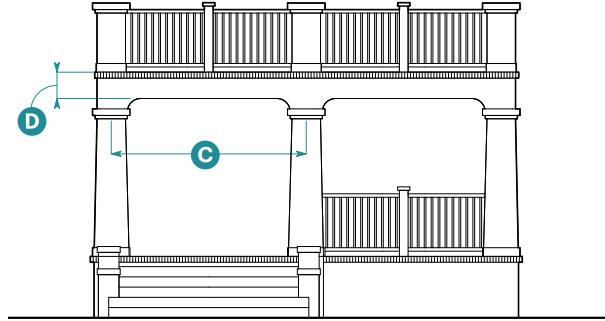

One-Story Porch with Deck Above

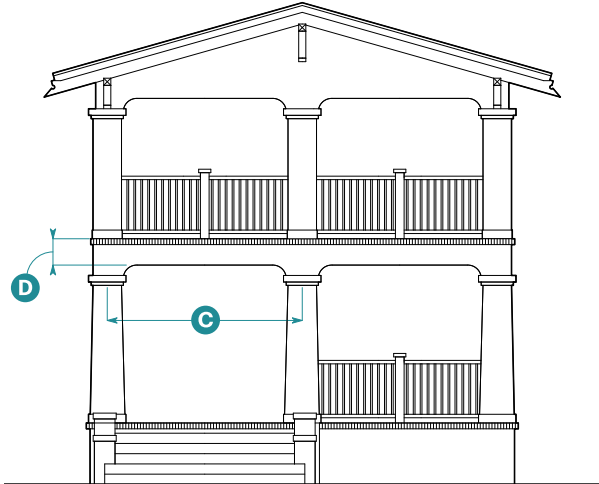

Two-Story Porch

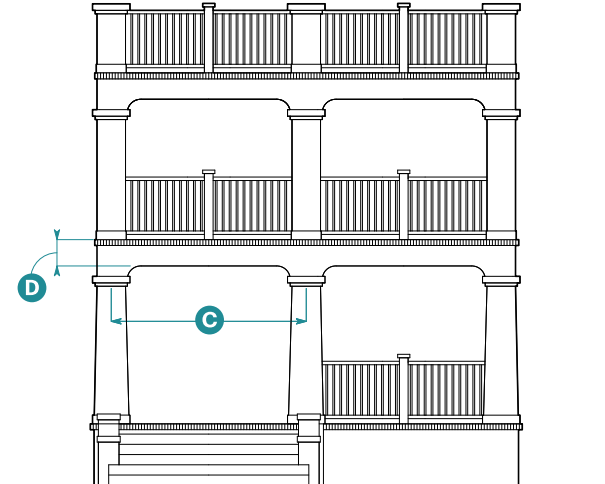

Two-Story Porch with Deck Above

14. Porches

Columns

Shape	Square-tapered
Base Width	1'10" min.
Spacing	9'6" min.; 12' max. on center C

Entablature

Height of Entablature Supporting Deck

Overall	10" min. D
---------	-------------------



Storefront Elevation

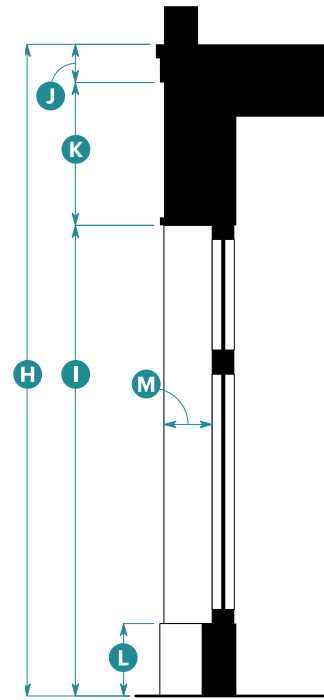

Storefront Section

15. Storefronts

Width

Storefront Module	10'0" min.; 15'0" max.	E
Display Window	3'0" min.; 4'0" max.	F
Distance Between Storefront Modules	1'0" min.; 2'0" max.	G

Height

Overall	13'0" min.	H
Head Height	10'0" min.	I
Cornice	10" min.	J
Signage Band	1'6" min.	K
Base	1'0" min.; 2'0" max.	L

Horizontal Recess

Depth	1'0" min.; 2'0" max.	M
-------	----------------------	----------

Base shall be continuous, unless divided by pilaster, and align with base height of building (if any).

Cornice shall be continuous.

16. Materials	
Element	Allowed Materials
Wall	
Wall Cladding	Shingle and lap siding: composite wood, wood, fiber cement; and stucco
Base	
Base or Foundation	Stone, cast stone, painted concrete
Roof and Roof Elements	
Roofing	Asphalt shingles, wood shingles, standing seam metal
Rake and Eave	Composite wood, wood
Cornice	Composite wood, wood
Brackets	Composite wood, wood, fiberglass
Gutter	Metal half-round
Windows, Bay Windows, and Entry Doors	
Trim or Surround	Composite wood, wood, fiber cement
Entry Door	Wood, aluminum, fiberglass, composite
Window Frames	Wood, aluminum-clad wood, aluminum, fiberglass
Glazing	Clear glass; shall not be tinted, mirrored, or colored
Balconies	
See Subsection 13 (Balconies) for allowed materials.	
Porches	
Columns	Composite wood, wood, metal
Railing	Composite wood, wood, metal
Storefronts	
Columns	Composite wood, wood, fiberglass, metal
Storefront Base	Wood panels, brick, stone tile, fiber cement



General note: The images above and the descriptions in Subsections 1 and 2 below are intended to provide a brief overview of the architectural style and are descriptive, not regulatory.

1. Description of Style

Main Street Classical style buildings combine influences from late 19th century Classical Revival and pre-war American main street architecture. With brick as a primary facade material, facades have a tripartite composition and often introduce ornament in a prominent cornice.

2. Typical Characteristics

Symmetrical facade composition with proportions that imply load-bearing masonry structure

Prominent cornice with classical detailing and parapet or pedimented roof forms

Regular pattern of vertically proportioned openings

Brick and stucco as primary facade materials

Elements of Main Street Classical Style – Mixed-Use Prototype

Note: The image below is intended to provide a reference for architectural elements and is illustrative, not regulatory. It is not an exhaustive list of applicable standards.

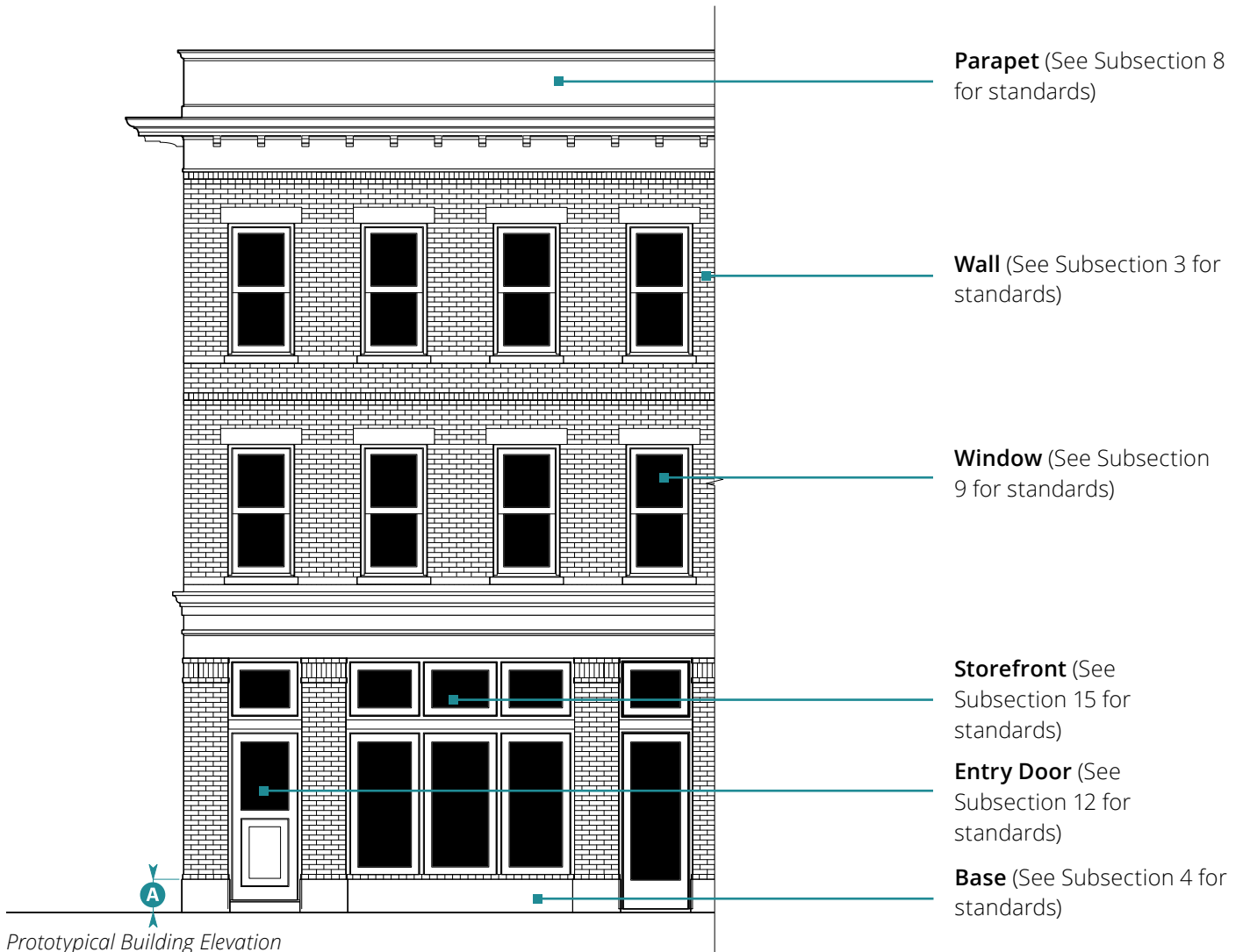

Prototypical Building Elevation

3. Wall
 No wall standards apply to this style. See Subsection 16 (Materials) for materials standards.

4. Base
 Height 1'0" min.; 2'0" max. **A**

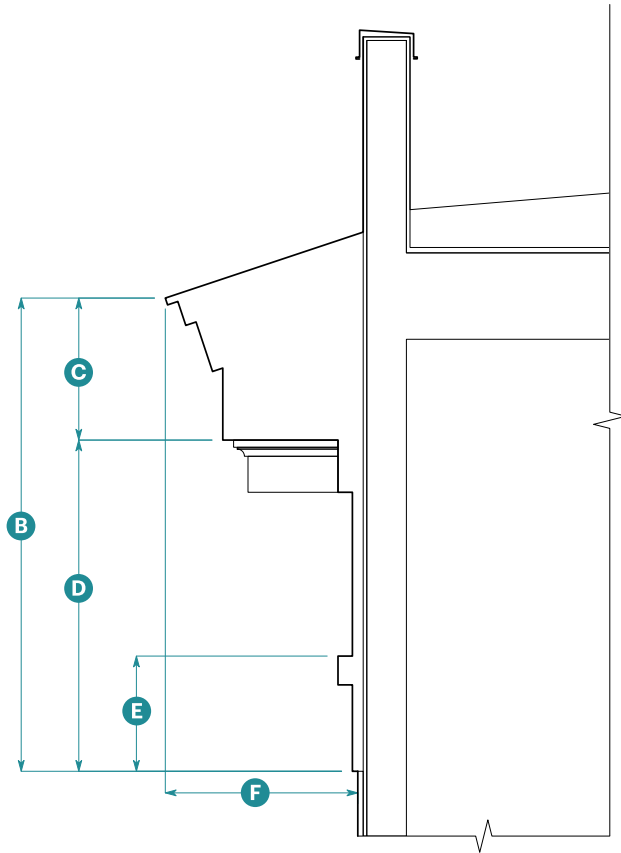

Parapet Section

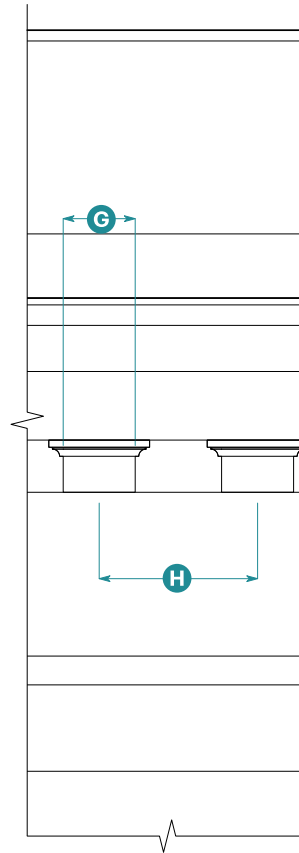

Parapet Elevation

5. Building Roof

Form

Roof Type Flat

6. Rake

Because this style does not allow sloped roofs, rake is not regulated. For wall-roof junction standards, see Subsection 8 (Parapet).

7. Eave

Because this style does not allow sloped roofs, eave is not regulated. For wall-roof junction standards, see Subsection 8 (Parapet).

8. Parapet

Height

Overall	5'6" min.	B
Cornice	1'8" min.	C
Fascia		
Overall	3'6" min.	D
Lower Band	1'2" min.	E

Horizontal Projection ¹

Overall	2'6" min.	F
---------	-----------	----------

Continuous cornice required on all street facing facades.

Required Ornament

Type	Dentils	
Width	10" min.	G
Spacing	2'0" max. on center	H
Placement	Below cornice at top of fascia	

¹ Horizontal projection includes gutter.

9. Windows

Opening

Proportion, Height I to Width J ²	
Ground Floor	2.0 min.
Upper Floor	1.75 min.

Typical Sizes, Width **J** x Height **I**

Ground Floor, Typical	3'0" x 6'6"
Ground Floor, Picture	4'6" x 6'6"
Upper Floor, Typical	3'0" x 5'6"
Upper Floor, Picture	4'6" x 5'6"
Privacy	2'0" x 4'0"

Shape	Square
-------	--------

Operation	Single Hung, Double Hung, Casement
-----------	------------------------------------

Window

Glazing Divisions	6 over 9; 6 over 6
-------------------	-----------------------

Frame Width (Frame + Sash)

At Rail	2.5" min. ± 1/4"	K
At Stile	2.5" min. ± 1/4"	L

Molding Widths

Head	2" min.	M
Jamb	2" min.	N

Window Frame Recess

Depth	2" min.
-------	---------

Sill

Depth	3" min.
-------	---------

Pediment

Allowed	Yes
---------	-----

"Typical" refers to a regular recurring window (i.e., size or lite pattern) on a facade.

¹Picture windows shall be wider than typical windows and equal in height to windows on the same floor.

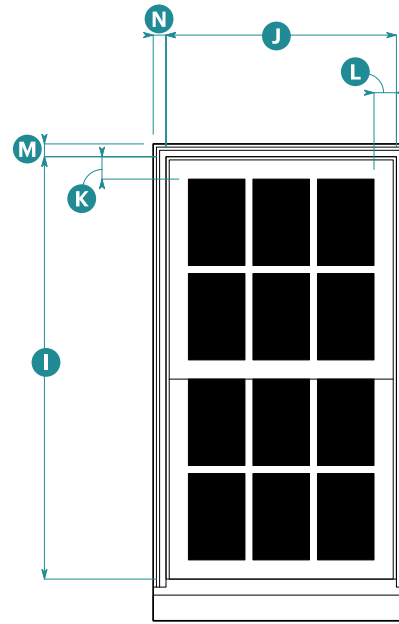

Upper Floor Typical Window Elevation
6 over 6

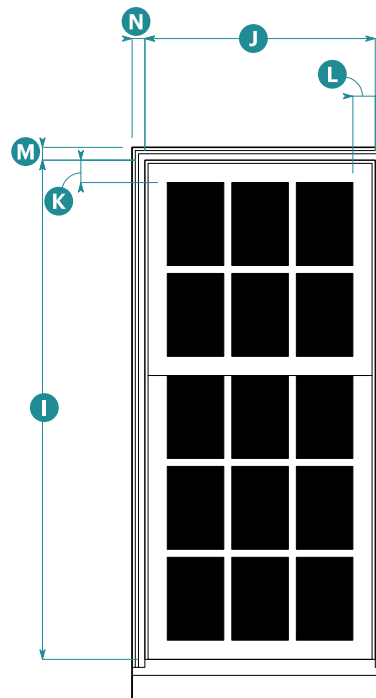

Ground Floor Typical Window Elevation
6 over 9

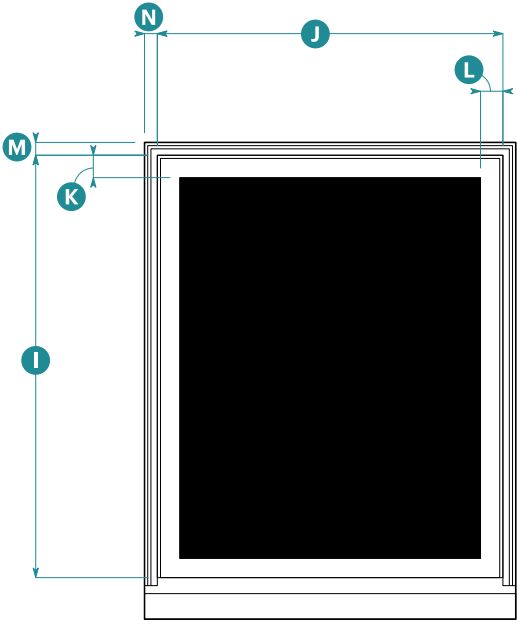

Upper Floor Picture Window Elevation

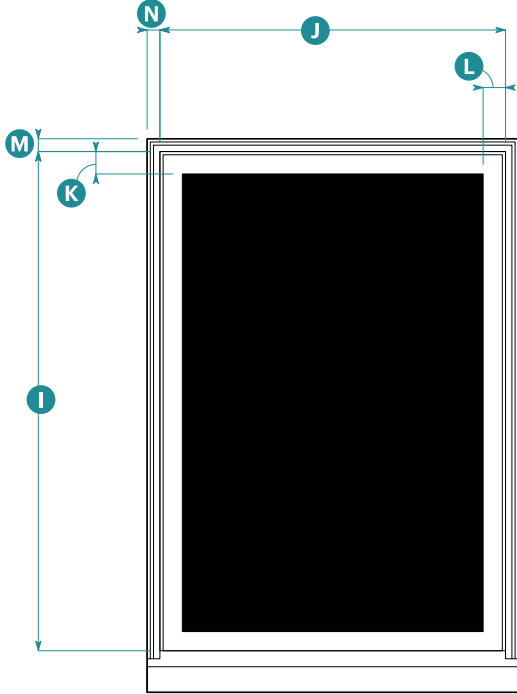

Ground Floor Picture Window Elevation

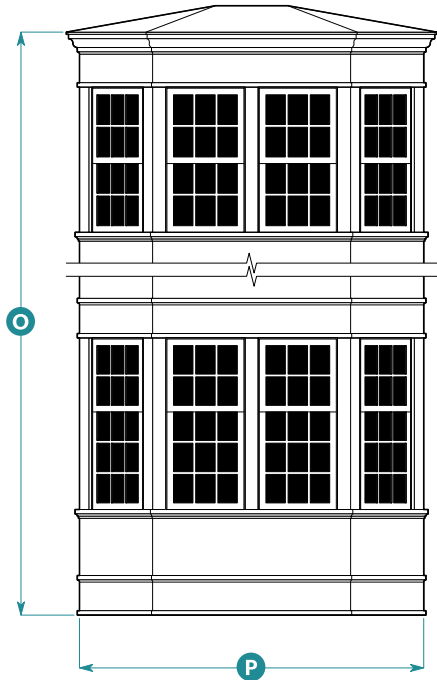

10. Bay Windows

Form

Type	Chamfered
Interior Angle	30 degrees min.; 55 degrees max.
Number of Faces	3 or 5

Size

Height		O
On buildings with heights up to 3 stories	2 stories max.	
On buildings with heights above 3 stories	2 stories plus 1 additional story for each building story over 3 max.	
Width	6'0" min.; 12'0" max.	P
Depth	1'0" min.; 3'0" max.	Q

Cornice Types

Cornice wraps bay.
 Bay stops below building cornice (bay has own cornice).

10. Bay Windows (Continued)

Bay returns into building cornice (bay never projects above the building cornice).

Additional Standards

Bay depth not allowed to project beyond cornice depth.
 Multi-story bay window form shall be vertically continuous.
 Continuous horizontal articulation on building shall wrap bay form.

11. Dormers

Because this style does not allow sloped roofs, dormers shall not be used.

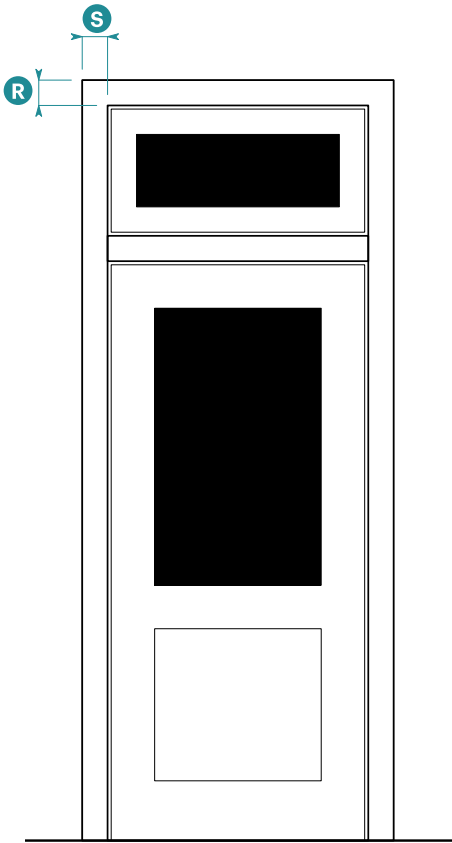

Entry Door Elevation

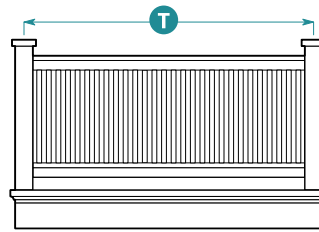

Type 1
Square Guardrail

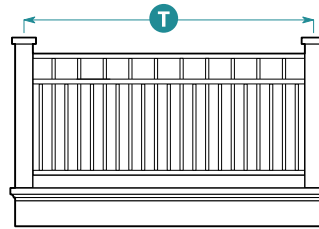

Type 2
Decorative Metal Guardrail

Balcony Front Elevation

12. Entry Doors

Door

Number of Panels 2 min.

Surround

Head Width 4" min. R

Jamb Width 4" min. S

Additional Elements

Transom Allowed

Pediment Allowed

13. Balconies

Allowed Materials

Type 1 - Square Guardrail

Post, Baluster, Handrail, Metal, composite wood, wood
Fascia, and Brackets

Type 2 - Decorative Metal Guardrail

Post, Handrail, Fascia, Metal, composite wood, wood
and Brackets

Baluster Metal

Size

Overall Balcony Width 10'0" max.

Width Between Posts 3' min. T

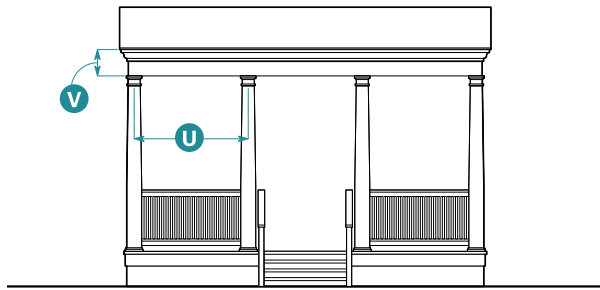

One-Story Porch

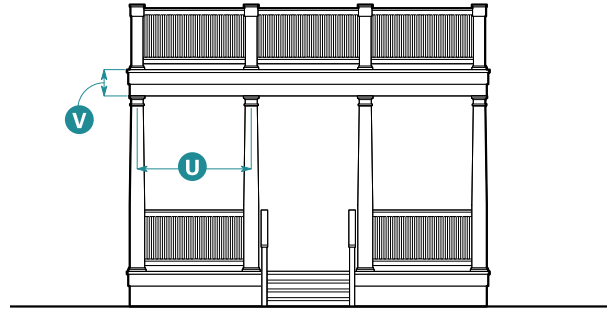

One-Story Porch with Deck Above

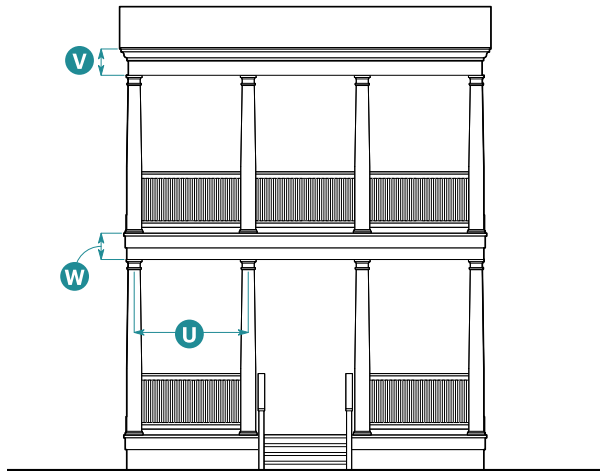

Two-Story Porch

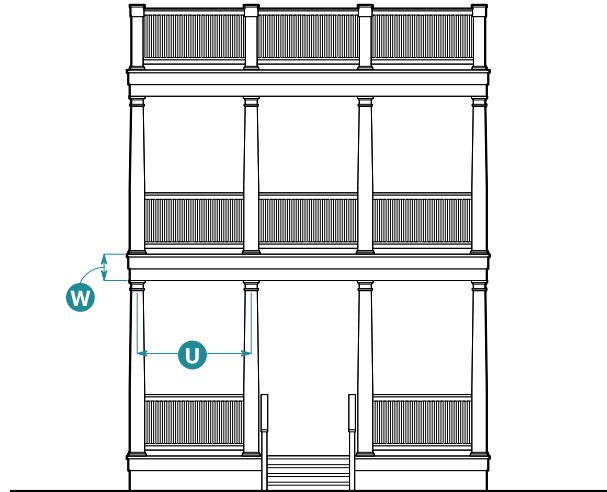

Two-Story Porch with Deck Above

14. Porches

Columns

Shape Clearly defined capital, base, and shaft; shaft either turned with entasis or square stock with optional detailing

Diameter 8" min.

Spacing 6'6" max. on center **U**

Entablature

Height of Topmost Entablature

Overall 1'6" min. **V**

Fascia 10" min.

Height of Floor-to-Floor Entablature

Overall 10" min. **W**



Storefront Elevation

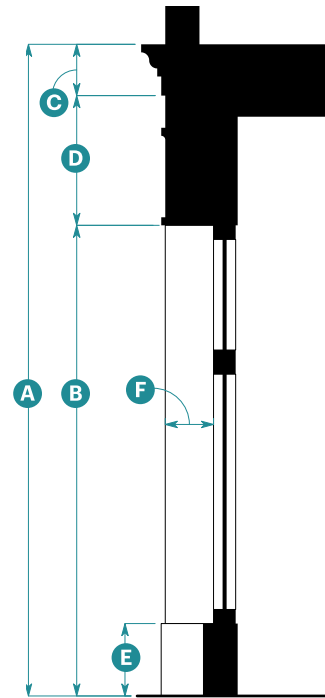

Storefront Section

15. Storefronts

Width

Storefront Module	10'0" min.; 15'0" max.	X
Display Window	3'0" min.; 4'0" max.	Y
Distance Between Storefront Modules	1'6" min.; 2'6" max.	Z

Height

Overall	13'0" min.	A
Head Height	10'0" min.	B
Cornice	10" min.	C
Signage Band	1'8" min.	D
Base	1'0" min.; 2'0" max.	E

Horizontal Recess

Depth	6" min.; 2'0" max.	F
-------	--------------------	---

Base shall be continuous, unless divided by pilaster, and align with base height of building (if any).

Cornice shall be continuous.

16. Materials	
Element	Allowed Materials
Wall	
Wall Cladding	Brick, stucco
Base	
Base or Foundation	Brick, stone
Windows, Bay Windows, and Entry Doors	
Lintel	Stone, concrete
Entry Door	Wood, aluminum-clad wood, aluminum
Window Frames	Wood, aluminum clad wood, aluminum, fiberglass
Glazing	Clear glass; shall not be tinted, mirrored, or colored
Balconies	
See Subsection 13 (Balconies) for allowed materials.	
Porches	
Columns	Composite wood, wood, cast stone, metal
Railing	Composite wood, wood, metal
Storefronts	
Storefront	Composite wood, wood, metal
Storefront Base	Wood panels, brick, stone tile, fiber cement



General note: The images above and the descriptions in Subsections 1 and 2 below are intended to provide a brief overview of the architectural style and are descriptive, not regulatory.

1. Description of Style

Mediterranean style buildings in Marin County draw from Spanish Colonial, Pueblo, and Spanish Revival influences. These buildings combine austere wall planes with punched, recessed openings for windows.

2. Typical Characteristics

Low-pitched gabled or hipped roofs clad in red tile with open eaves

Flat, rectilinear wall plane with vertically proportioned punched openings without trim

Stucco as primary facade material with stucco or wood attached elements

Elements of Mediterranean Style – Multifamily Prototype

Note: The image below is intended to provide a reference for architectural elements and is illustrative, not regulatory. It is not an exhaustive list of applicable standards.

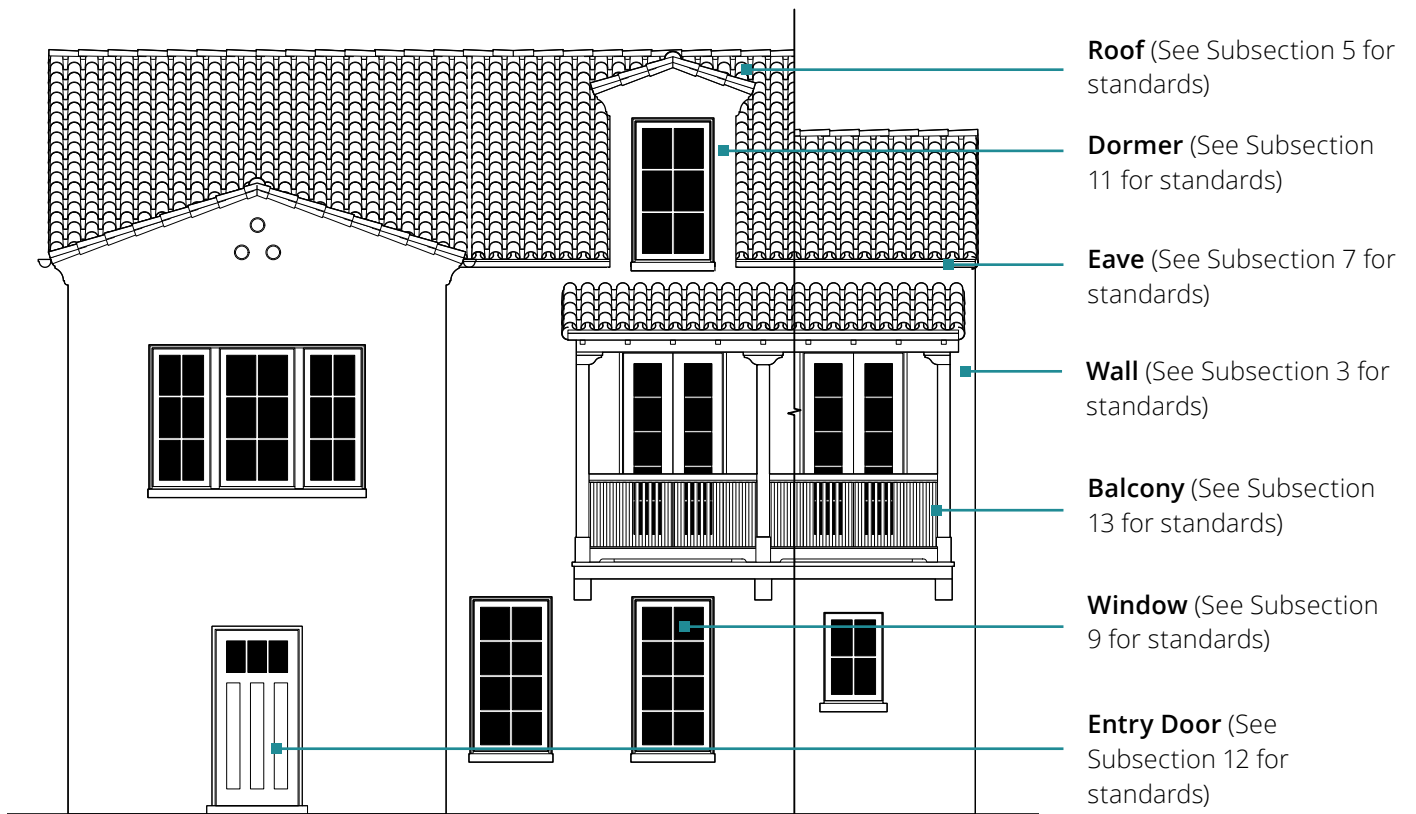

Prototypical Building Elevation

3. Wall

No wall standards apply to this style. See Subsection 16 (Materials) for materials standards.

4. Base

None required

Elements of Mediterranean Style – Mixed-Use Prototype

Note: The image below is intended to provide a reference for architectural elements and is illustrative, not regulatory. It is not an exhaustive list of applicable standards.

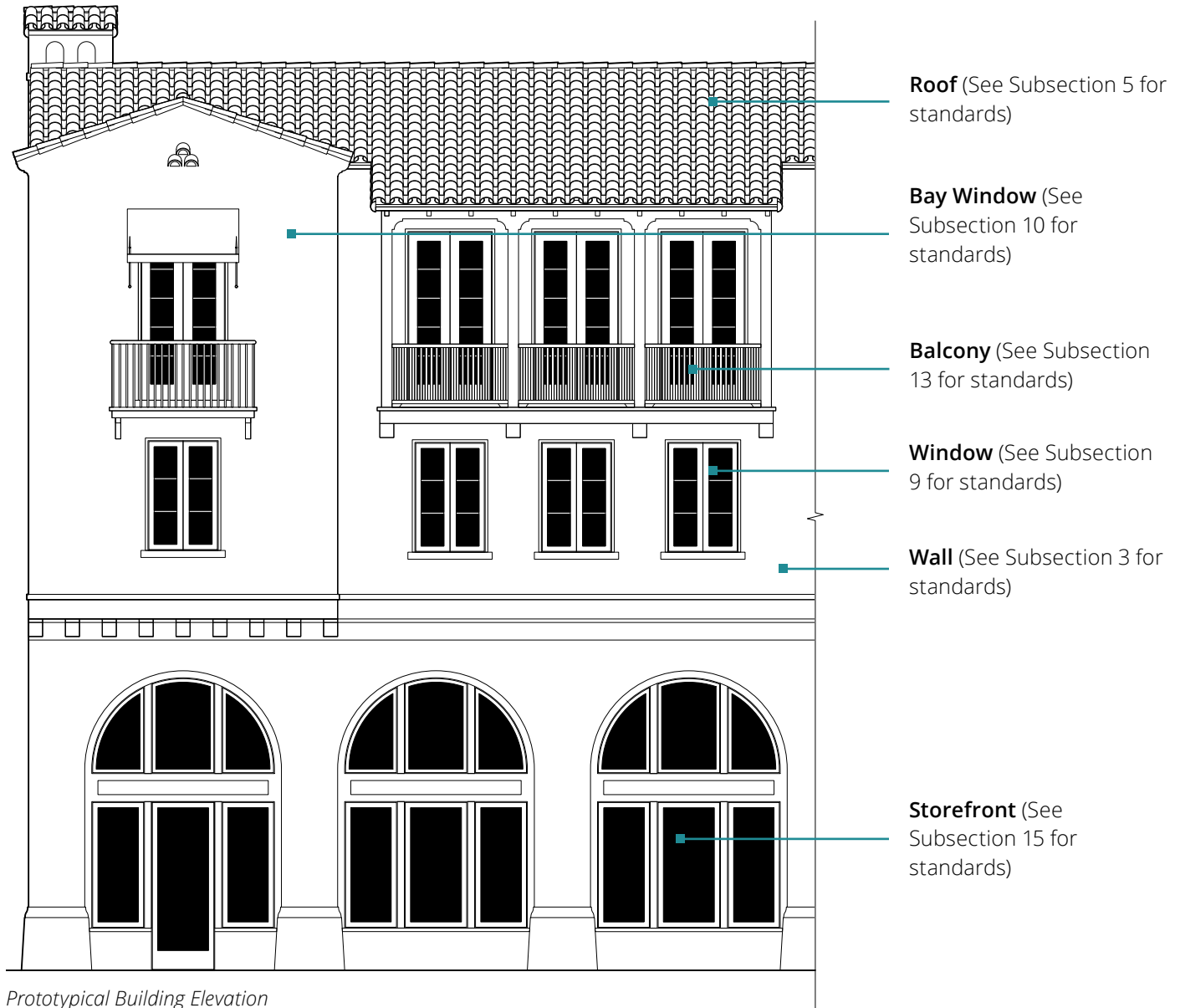

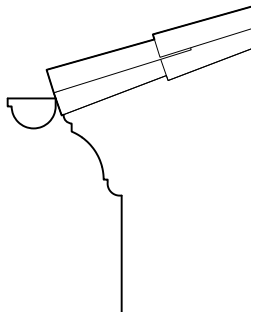

Closed Eave Elevation

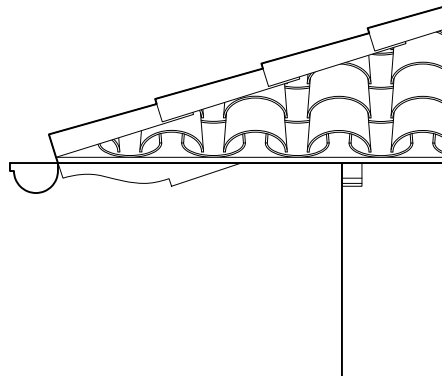

Open Eave Elevation

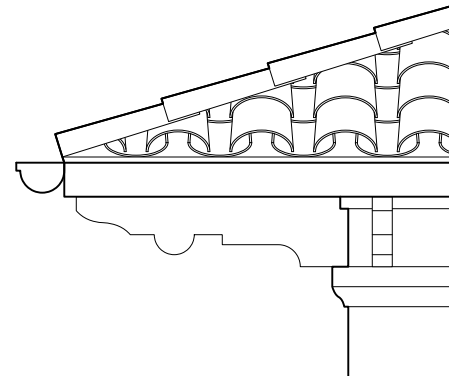

Returned Eave Elevation

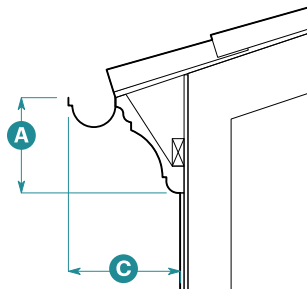

Closed Eave Section

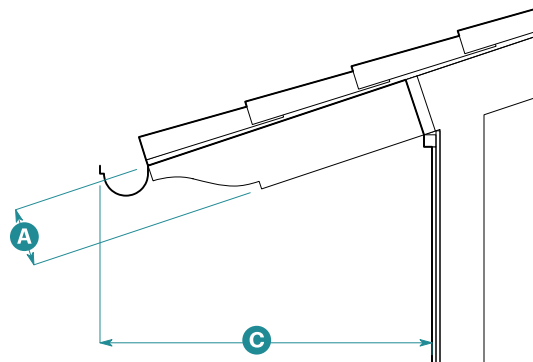

Open Eave Section

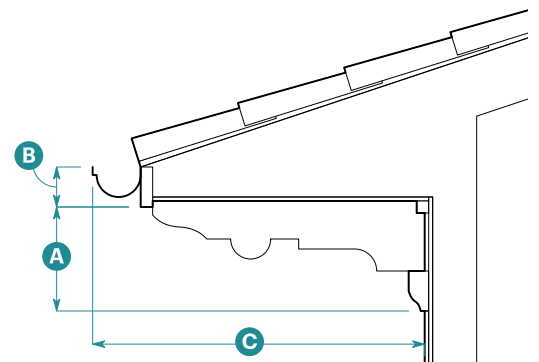

Returned Eave Section

5. Building Roof

Building Roof Standards	Sloped Roof	Flat Roof
Applicable Subsections		
Subsection 6 (Rake)	A	N/A
Subsection 7 (Eave)	A	N/A
Subsection 8 (Parapet)	N/A	A

Form

Pitch	4:12 min.; 6:12 max.	N/A
-------	-------------------------	-----

6. Rake

No specialized rake profile

7. Eave

Standards	Closed	Open	Returned
Height			
Supporting Element	1'0" min.	8" min.	1'0" min. A
Fascia	None	None	6" min. B
Horizontal Projection ¹			
Overall	1'0" min.	3'0" min.	2'6" min. C

¹Horizontal projection includes gutter.

A = Applicable N/A = Not Applicable

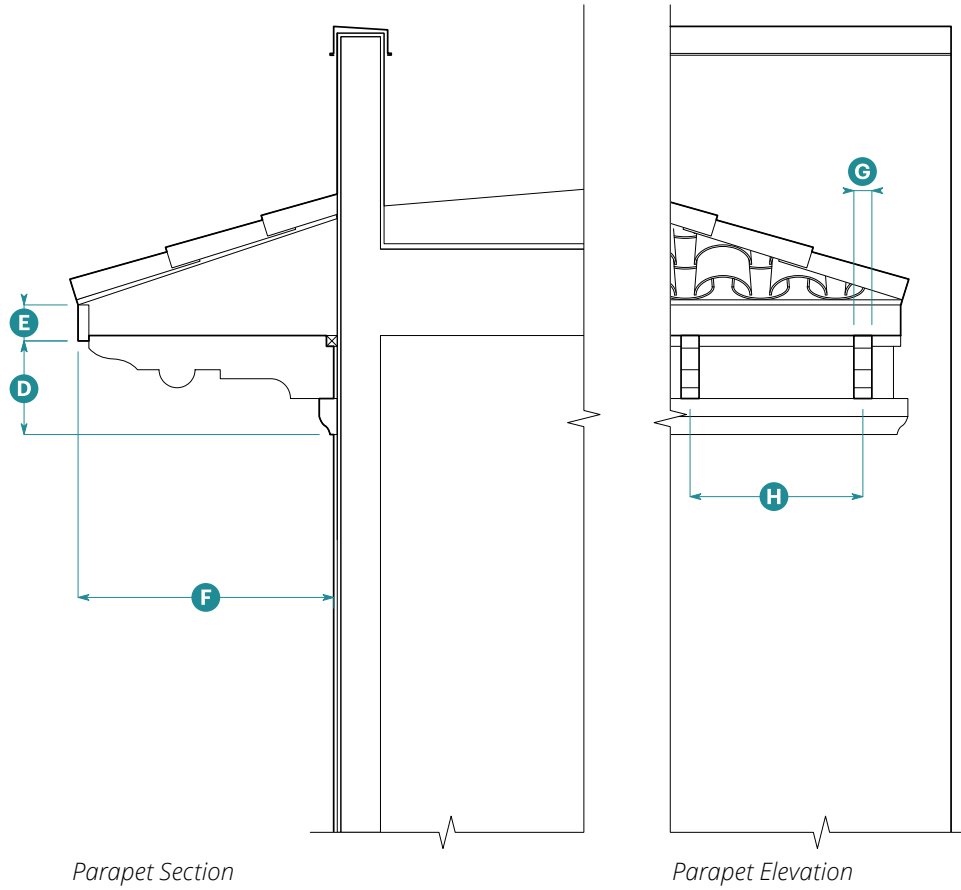

8. Parapet		
Height		
Supporting Element	1'8" min.	D
Fascia	6" min.	E
Horizontal Projection²		
Overall	2'0" min.	F
Continuous cornice required on all street facing facades.		
Required Ornament		
Type	Brackets	
Width	3" min.	G
Spacing	24" max. on center	H
Placement	Below fascia	

²Horizontal projection includes gutter.

9. Windows

Opening

Proportion, Height **I** to Width **J**³

Ground Floor	2.0 min.
Upper Floor	1.75 min.
Dormer	See Subsection 11 (Dormers) for standards.

Typical Sizes, Width **J** x Height **I**

Ground Floor, Typical	3'0" x 6'0"
Ground Floor, Ganged	2'4" x 6'0"
Ground Floor, Picture	4'6" x 6'0"
Upper Floor, Typical	3'0" x 5'6"
Upper Floor, Ganged	2'4" x 5'6"
Upper Floor, Picture	4'6" x 5'6"
Privacy	2'0" x 4'0"

Shape	Square, arched
-------	----------------

Operation	Casement
-----------	----------

Window

Glazing Divisions	6 parts or 8 parts
-------------------	--------------------

Frame Width (Frame + Sash)

At Rail	2.5" min. ± 1/4"	K
At Stile	2.5" min. ± 1/4"	L

Molding Widths

Head	2" min.	M
Jamb	2" min.	N
Apron	None required	

Window Frame Recess

Depth	2" min.
-------	---------

Sill

Depth	2" min.
-------	---------

Pediment

Allowed	No
---------	----

Mullions

Mullions required between ganged windows.

"Typical" refers to a regular recurring window (i.e., size or lite pattern) on a facade.

¹Picture windows shall be wider than typical windows and equal in height to windows on the same floor.

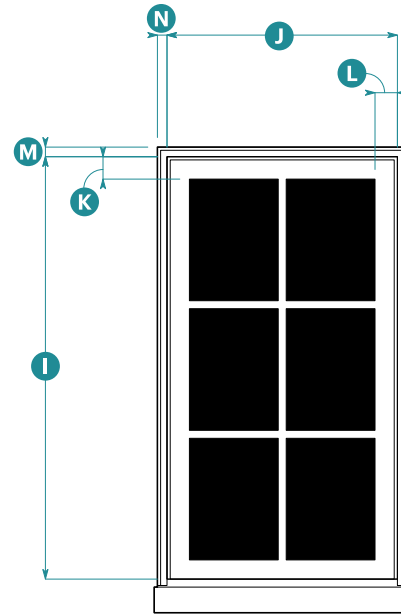

Upper Floor Typical Window Elevation
6 parts

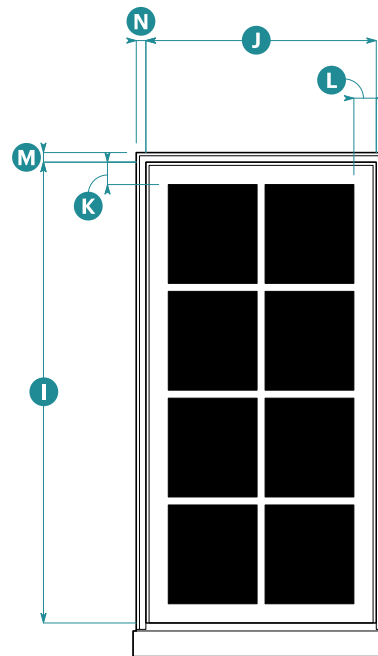

Ground Floor Typical Window Elevation
8 parts

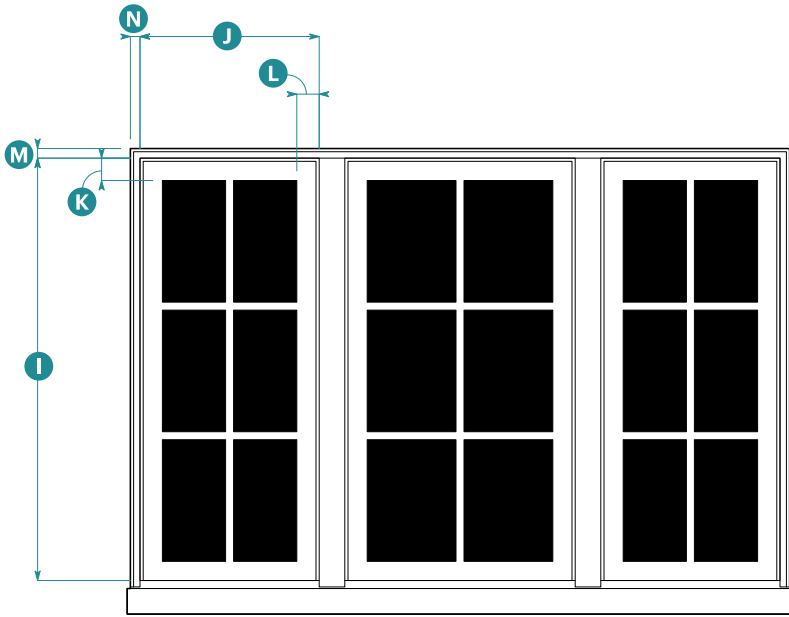

Upper Floor Ganged Window Elevation
6 parts

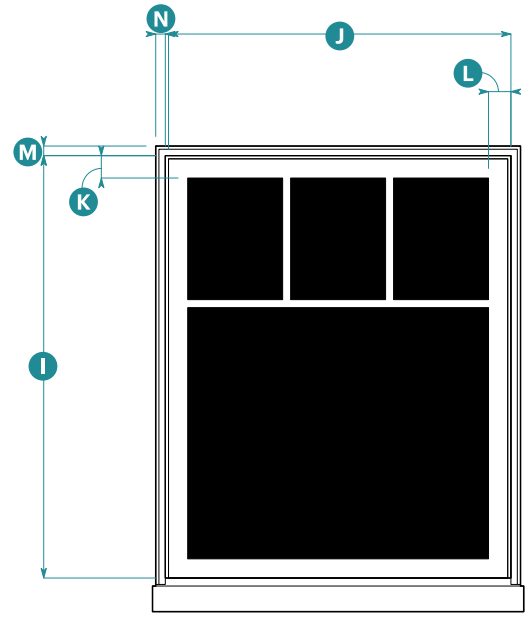

Upper Floor Picture Window Elevation

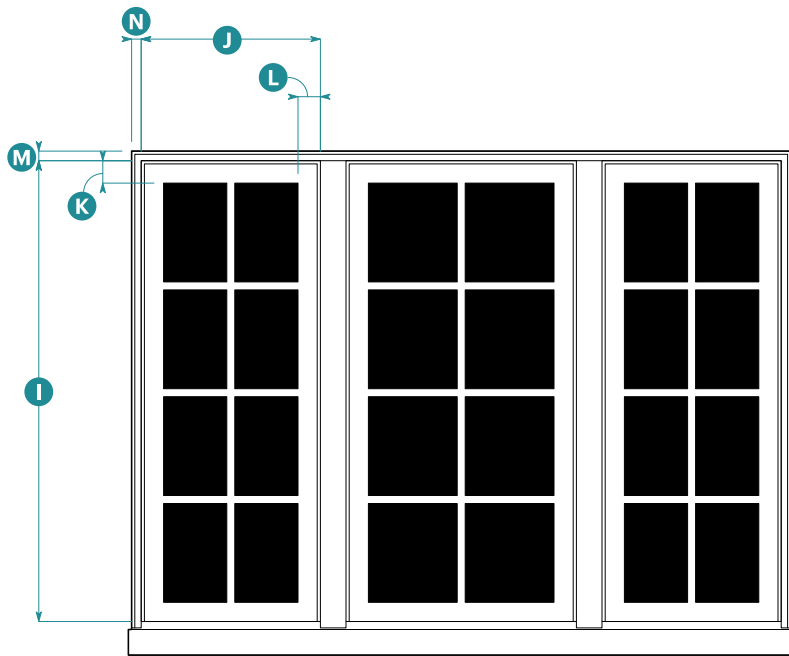

Ground Floor Ganged Window Elevation
8 parts

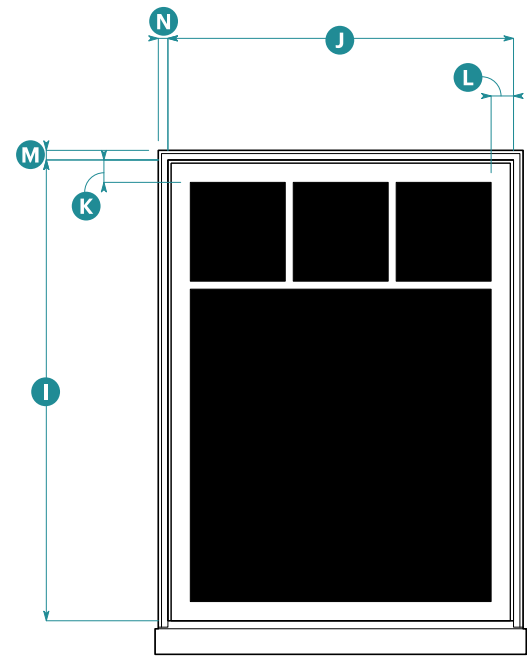

Ground Floor Picture Window Elevation



Bay Window Plan

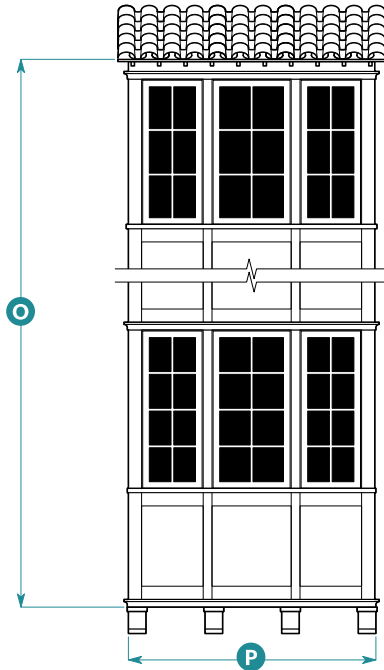

Bay Window Elevation

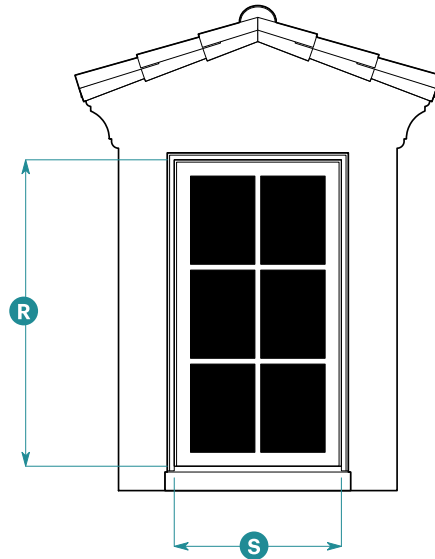

Dormer Elevation

10. Bay Windows

Form

Type Square

Size

Height O

- On buildings with heights up to 3 stories 2 stories max.
- On buildings with heights above 3 stories 2 stories plus 1 additional story for each building story over 3 max.

Width 6'0" min.; 12'0" max. P

Depth 1'0" min.; 3'0" max. Q

Cornice Types

- Building eave wraps bay.
- Bay stops below building eave (bay has own cornice).
- Bay returns into building eave (bay never projects above the building eave).

Additional Standards

Bay depth not allowed to project beyond eave depth.

10. Bay Windows (Continued)

Multi-story bay window form shall be vertically continuous. Continuous horizontal articulation on building shall wrap bay form.

Corner bay may be turned on side to be rotated 45 degrees from building corner.

11. Dormers

Roof Form

Type Gable

Pitch 4:12 min.; 8:12 max.

Window

Proportion, Height R to Width S 1.75 min.

Width 3'0" min. S

Pediment

Allowed No

Dormers allowed for buildings with half stories.

See Subsections 6 (Rake), 7 (Eave), and 9 (Windows) for additional standards.

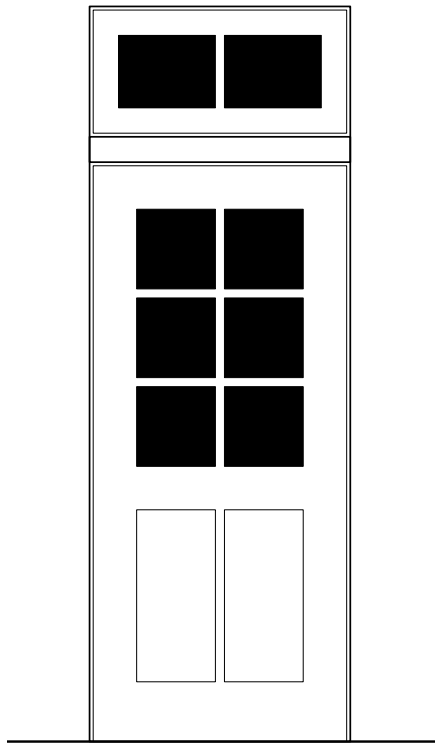

Entry Door Elevation

12. Entry Doors	
Door	
Number of Panels	2 min.
Surround	
None required	
Additional Elements	
Transom	Allowed
Pediment	Not Allowed

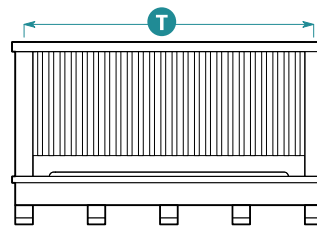

Type 1
Square Guardrail

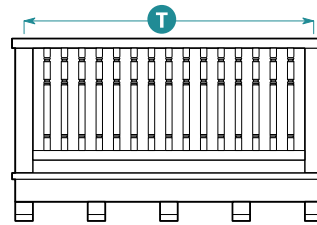

Type 2
Turned Guardrail

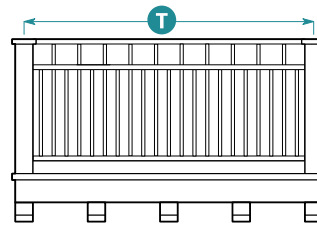

Type 3
Decorative Metal Guardrail

Balcony Front Elevation

13. Balconies	
Allowed Materials	
Type 1 - Square Guardrail	
Post, Baluster, Handrail, Fascia, and Brackets	Metal, composite wood, wood
Type 2 - Turned Guardrail	
Post, Baluster, Handrail, Fascia, and Brackets	Metal, composite wood, wood
Type 3 - Decorative Metal Guardrail	
Post, Handrail, Fascia, and Brackets	Metal, composite wood, wood
Baluster	Metal
Size	
Overall Balcony Width	10'0" max.
Width Between Posts	3' min.



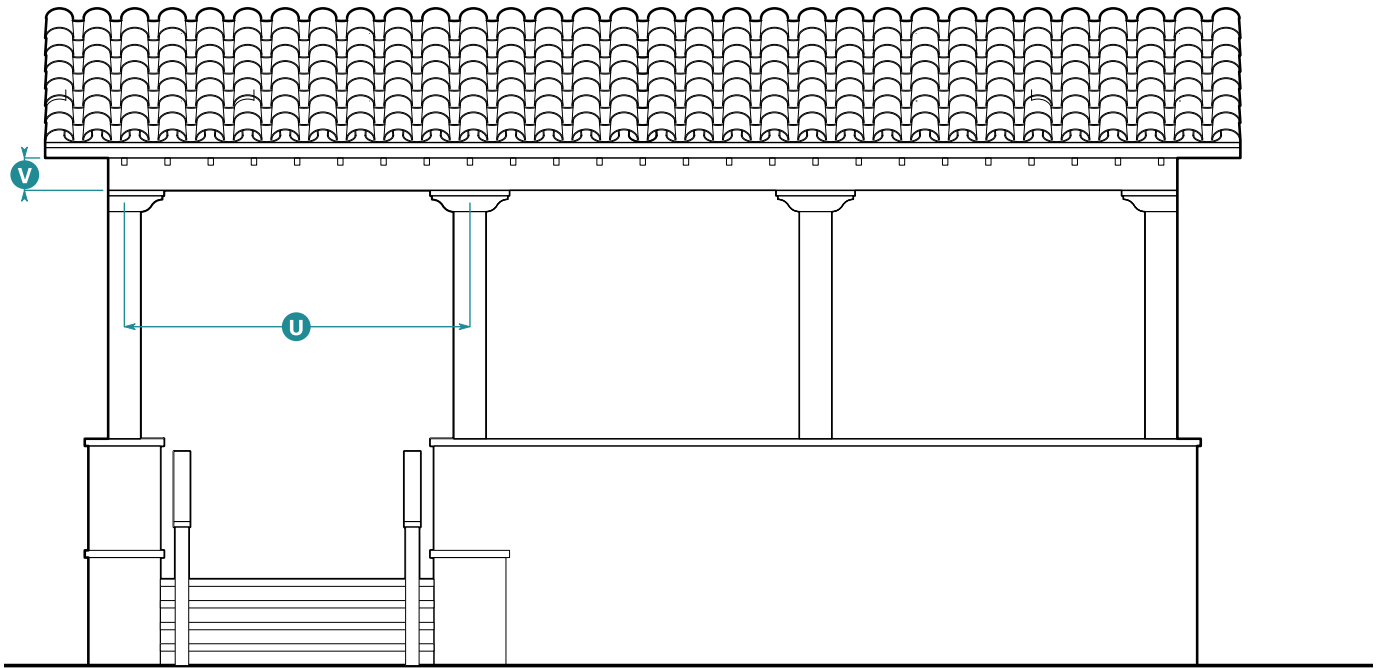

Porch Elevation

14. Porches

Columns

Shape	Square or round, with capitals or brackets	
Diameter	8" min.	
Spacing	9'0" max. on center	U

Entablature

Overall	10" min.	V
---------	----------	---

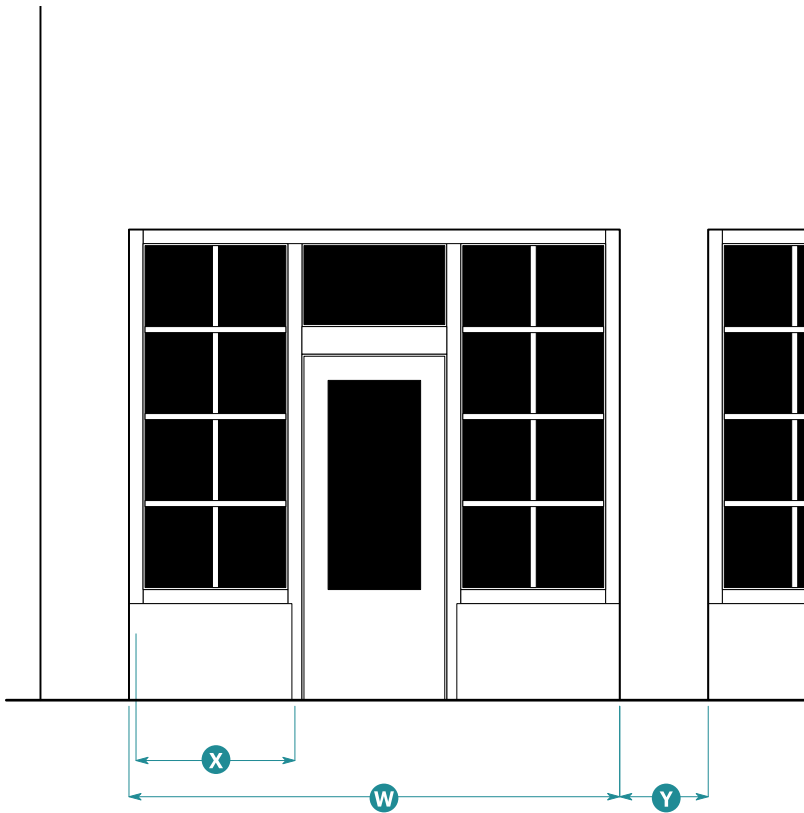

Storefront Elevation

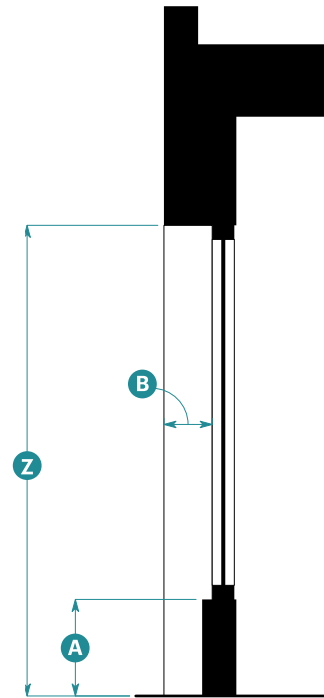

Storefront Section

15. Storefronts

Width

Storefront Module	10'0" min.; 15'0" max.	W
Display Window	3'0" min.; 4'0" max.	X
Distance Between Storefront Modules	1'6" min.; 2'6" max.	Y

Height

Head Height	11'0" min.	Z
Cornice	None	
Signage Band	None	
Base	1'0" min.; 2'0" max.	A

Horizontal Recess

Depth	6" min.; 9" max.	B
-------	------------------	---

Base shall be continuous, unless divided by pilaster, and align with base height of building (if any).

16. Materials	
Element	Allowed Materials
Wall	
Wall Cladding	Stucco
Roof and Roof Elements	
Roofing	Terracotta clay barrel tiles
Rake and Eave	Wood, composite wood, stucco
Cornice	Wood, composite wood, stucco
Brackets	Composite wood, wood, or fiberglass
Gutter	Metal half-round
Windows, Bay Windows, and Entry Doors	
Entry Door	Wood, aluminum, fiberglass, composite
Window Frames	Wood, aluminum-clad wood, aluminum, fiberglass
Sill	Stucco, cast stone
Glazing	Clear glass; shall not be tinted, mirrored, or colored
Balconies	
See Subsection 13 (Balconies) for allowed materials.	
Porches	
Columns	Composite wood, wood, fiberglass, metal
Railing	Wood, wrought iron
Storefronts	
Storefront	Composite wood, wood, metal
Storefront Base	Stucco, tile

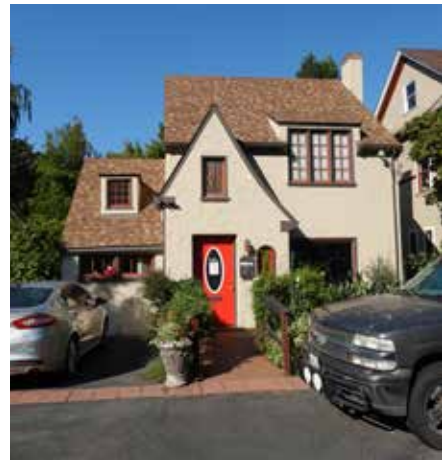

General note: The images above and the descriptions in Subsections 1 and 2 below are intended to provide a brief overview of the architectural style and are descriptive, not regulatory.

1. Description of Style

Tudor style buildings are inspired by the Storybook and Tudor Revival styles that emerged in America in the late 19th century. Its origins are in late Medieval English construction, reflected in faux half-timbering often expressed in upper stories. Initially used in formal civic buildings, the style became popular in Marin communities for main street building types.

2. Typical Characteristics

Prominent gabled roof forms with steep pitch and open eaves

Vertically proportioned openings with surround

Brick and stucco as primary facade materials, often with half-timbering at upper floors

Open eaves

Elements of Tudor Style – Multifamily Prototype

Note: The image below is intended to provide a reference for architectural elements and is illustrative, not regulatory. It is not an exhaustive list of applicable standards.



Prototypical Building Elevation

3. Wall	
Half-Timbering Trim	
Width	10" min. A
Align bottom of half-timbering with bottom of porch entablature, where occurs. B	

4. Base	
None required	

Elements of Tudor Style – Mixed-Use Prototype

Note: The image below is intended to provide a reference for architectural elements and is illustrative, not regulatory. It is not an exhaustive list of applicable standards.





Gable End Elevation

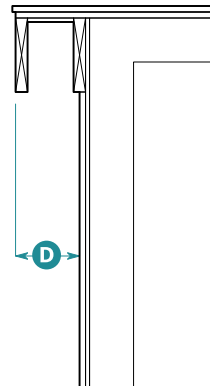

Rake Section

5. Building Roof

Building Roof Form

Pitch 10:12 min.

Gable End Form

Pitch 12:12 min. **C**

6. Rake

Horizontal Projection to 8" min. **D**

Fascia

See Subsection 7 (Eave) for height standards.

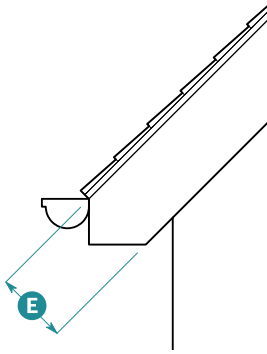

Open Eave Elevation

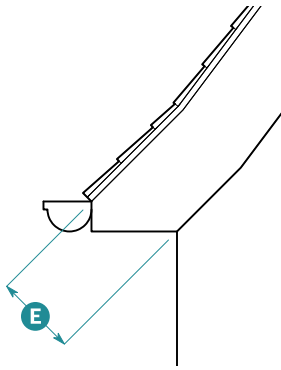

Returned Eave Elevation

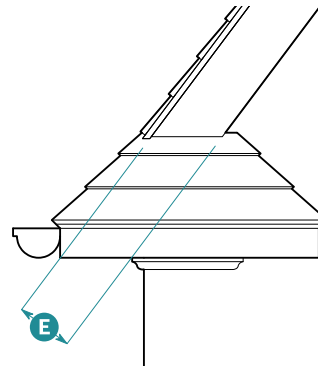

Returned Eave
Alternate Elevation

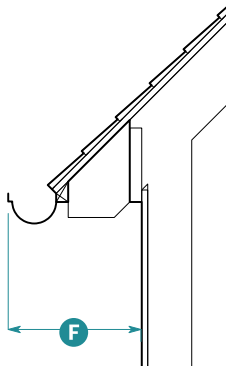

Open Eave Section

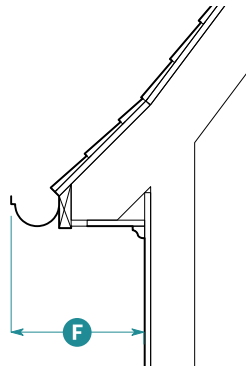

Returned Eave Section

7. Eave			
Standards	Open Eave	Returned Eave	
Height			
Overall	8" min.	10" min.	E
Horizontal Projection ¹			
Overall	1'0" min.	1'0" min.	F

¹ Horizontal projection includes gutter.

8. Parapet

No flat roofs are allowed in this style and parapet standards are not applicable. See Subsection 5 (Roof), Subsection 6 (Rake) and Subsection 7 (Eave) for standards applicable to sloped roofs.

9. Windows

Opening

Proportion, Height **G** to Width **H**²

Ground Floor	2.0 min.
Upper Floor	1.75 min.
Dormer	See Subsection 11 (Dormers) for standards.

Typical Sizes, Width **H** x Height **G**

Ground Floor, Typical	3'0" x 6'0"
Ground Floor, Ganged	2'4" x 6'0"
Ground Floor, Picture	4'6" x 6'0"
Upper Floor, Typical	3'0" x 5'6"
Upper Floor, Ganged	2'4" x 5'6"
Upper Floor, Picture	4'6" x 5'6"
Privacy	2'0" x 4'0"
Shape	Square
Operation	Single Hung, Double Hung, Casement

Window

Glazing Divisions	6 parts min.; 24 parts max.
Frame Width (Frame + Sash)	
At Rail	2.5" min. ± 1/4" I
At Stile	2.5" min. ± 1/4" J
Trim Widths	
Head	None required
Jamb	None required
Apron	None required

Window Frame Recess

Depth	2" min.
-------	---------

Sill

Depth	3" min.
-------	---------

Pediment

Allowed	No
---------	----

Mullions

Mullions required between ganged windows.

"Typical" refers to a regular recurring window (i.e., size or lite pattern) on a facade.

¹ Picture windows shall be wider than typical windows and equal in height to windows on the same floor.

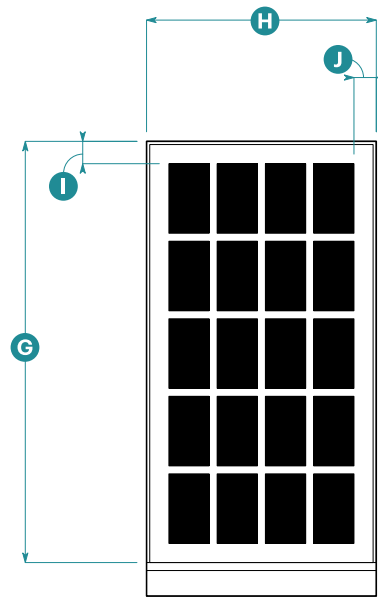

Upper Floor Typical Window Elevation
20 parts

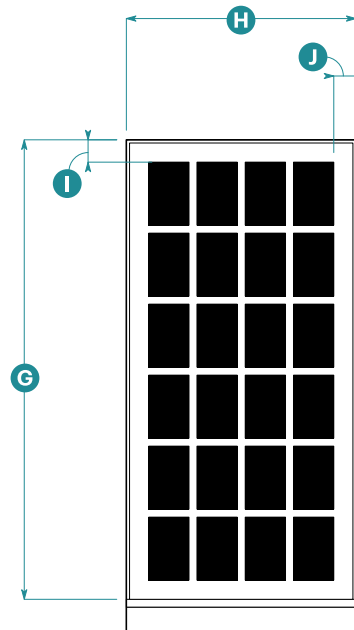

Ground Floor Typical Window Elevation
24 parts

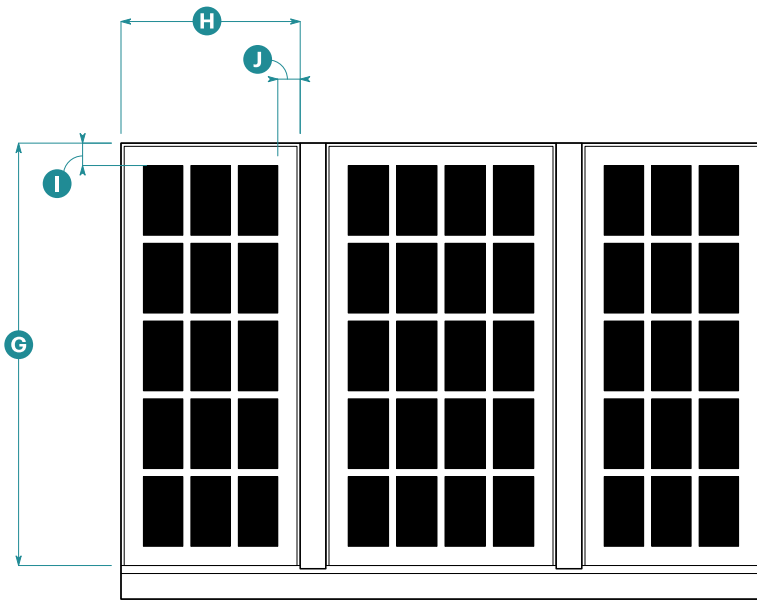

Upper Floor Ganged Window Elevation
15 parts and 20 parts

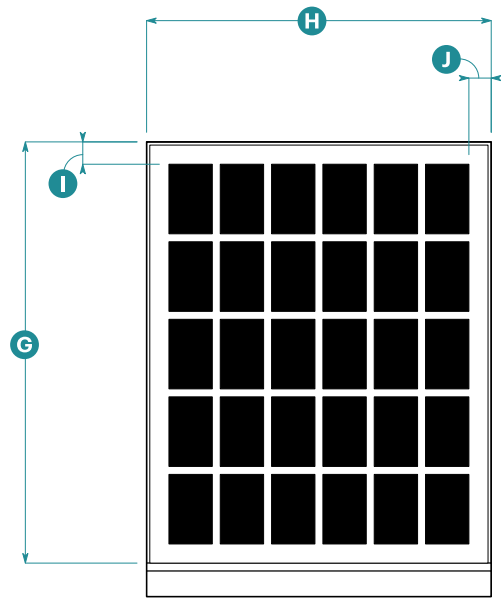

Upper Floor Picture Window Elevation

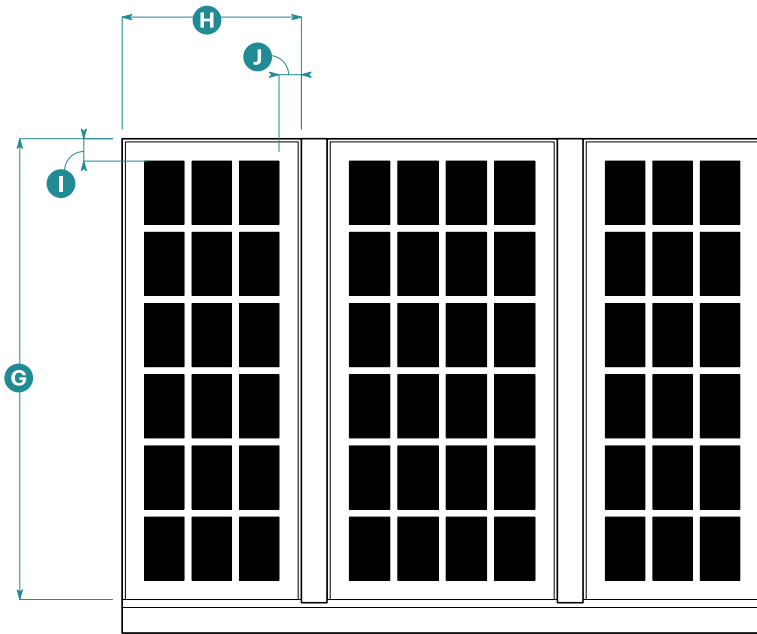

Ground Floor Ganged Window Elevation
18 parts and 24 parts

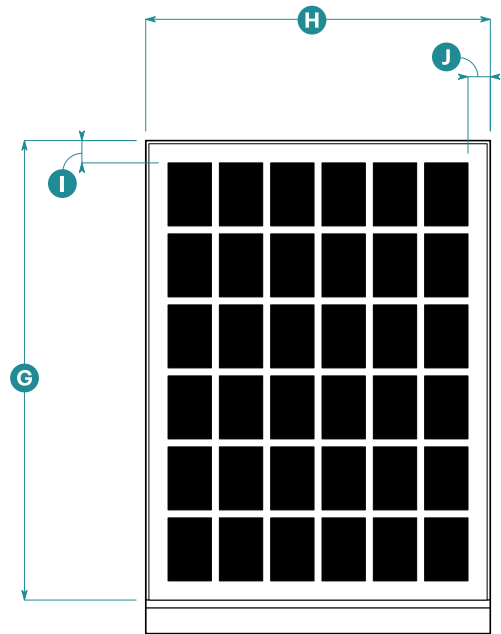

Ground Floor Picture Window Elevation



Bay Window Plan

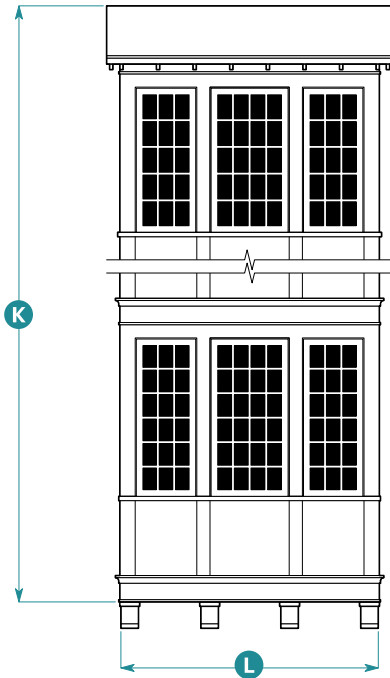

Bay Window Elevation

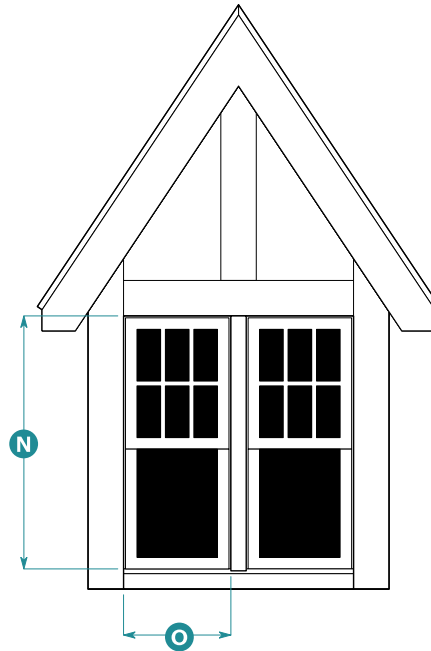

Dormer Elevation

10. Bay Windows

Form

Type Square

Size

Height (K)

- On buildings with heights up to 3 stories 2 stories max.
- On buildings with heights above 3 stories 2 stories plus 1 additional story for each building story over 3 max.

Width 6'0" min.; 12'0" max. (L)

Depth 1'0" min.; 3'0" max. (M)

Cornice Types

- Building eave wraps bay.
- Bay stops below building eave (bay has own cornice).
- Bay returns into building eave (bay never projects above the building eave).

Additional Standards

Bay depth not allowed to project beyond eave depth.

10. Bay Windows (Continued)

Multi-story bay window form shall be vertically continuous. Continuous horizontal articulation on building shall wrap bay form.

Corner bay may be turned on side to be rotated 45 degrees from building corner.

11. Dormers

Roof Form

Type Gable
Pitch 12:12 min.

Window

Proportion, Height 1.75 min.
(N) to Width (O)
Width 3'0" min. (O)

Pediment

Allowed No
Dormers allowed only for buildings with half stories.

See Subsections 6 (Rake), 7 (Eave), and 9 (Windows) for additional standards.

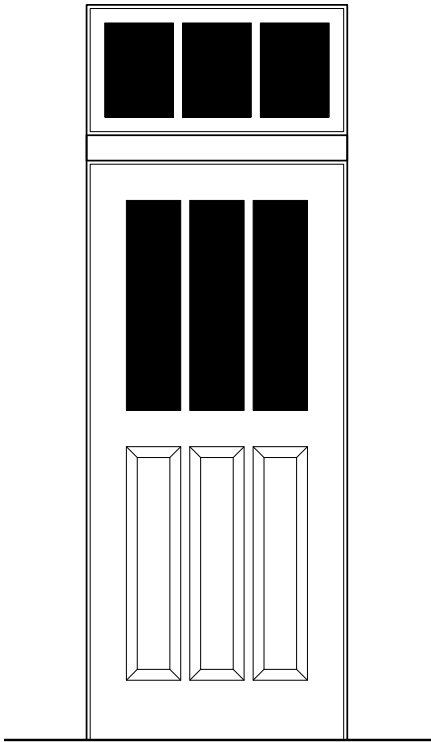

Entry Door Elevation

12. Entry Doors

Door

Number of Panels 2 min.

Surround

None required

Additional Elements

Transom Allowed

Pediment Not Allowed

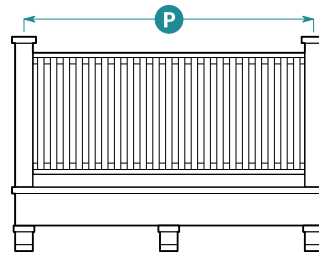

Type 1
Square Guardrail

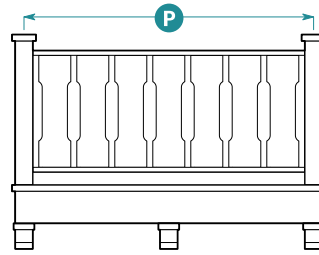

Type 2
Flat Sawn Guardrail

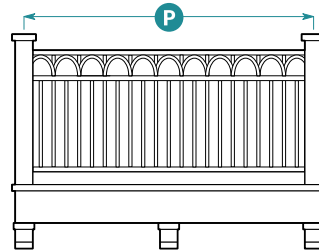

Type 3
Decorative Metal Guardrail

Balcony Front Elevation

13. Balconies

Allowed Materials

Type 1 - Square Guardrail

Post, Baluster, Handrail, Metal, composite wood, wood
Fascia, and Brackets

Type 2 - Flat Sawn Guardrail

Post, Baluster, Handrail, Metal, composite wood, wood
Fascia, and Brackets

Type 3 - Decorative Metal Guardrail

Post, Handrail, Fascia, Metal, composite wood, wood
and Brackets

Baluster Metal

Size

Overall Balcony Width 10'0" max.

Width Between Posts 3' min.





One-Story Porch



One-Story Porch with Deck Above



Two-Story Porch

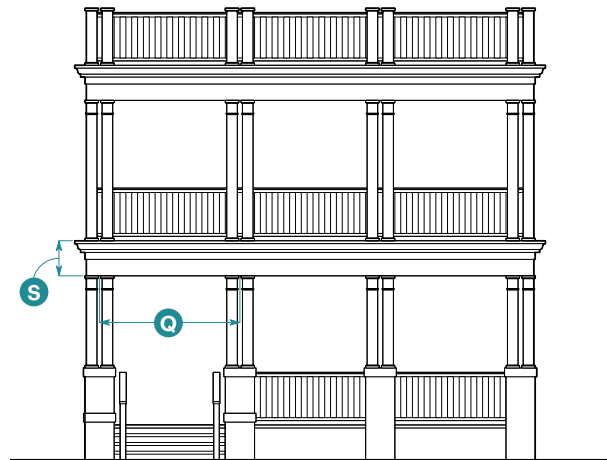

Two-Story Porch with Deck Above

14. Porches

Columns

Shape	Square stock (paired)
Width	6" min. each
Spacing	8' max. on center Q

Entablature

Height of Topmost Entablature

Overall	1'6" min. R
---------	--

Height of Floor-to-Floor Entablature

Overall	10" min. S
---------	---



Storefront Elevation

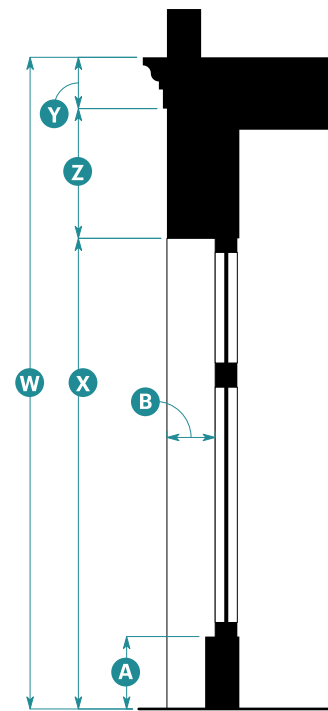

Storefront Section

15. Storefronts

Width

Storefront Module	10'0" min.; 15'0" max.	T
Display Window	3'0" min.; 4'0" max.	U
Distance Between Storefront Modules	1'0" min.; 2'0" max.	V

Height

Overall	13'0" min.	W
Head Height	10'0" min.	X
Cornice	10" min.	Y
Signage Band	1'6" min.	Z
Base	1'0" min.; 2'0" max.	A

Horizontal Recess

Depth	6" min.; 1'0" max.	B
-------	--------------------	---

Base shall be continuous, unless divided by pilaster, and align with base height of building (if any).

Cornice shall be continuous.

16. Materials	
Element	Allowed Materials
Wall	
Wall Cladding	Stone, stucco, brick, composite wood, wood, fiber cement
Base	
Base or Foundation	Brick, stone, cast stone, painted concrete, stucco
Roof and Roof Elements	
Roofing	Asphalt shingles, slate
Rake and Eave	Composite wood, wood
Cornice	Composite wood, wood
Brackets	Composite wood, wood, fiberglass
Gutter	Metal half-round
Windows, Bay Windows, and Entry Doors	
Trim or Surround	Composite wood, wood, fiber cement
Entry Door	Wood, aluminum, fiberglass, composite
Window Frames	Wood, aluminum-clad wood, aluminum, fiberglass
Glazing	Clear glass; shall not be tinted, mirrored, or colored
Balconies	
See Subsection 13 (Balconies) for allowed materials.	
Porches	
Columns	Composite wood, wood, fiberglass, metal
Railing	Composite wood, wood, wrought iron
Storefronts	
Storefront	Composite wood, wood, metal
Storefront Base	Wood panels, brick, fiber cement



General note: The images above and the descriptions in Subsections 1 and 2 below are intended to provide a brief overview of the architectural style and are descriptive, not regulatory.

1. Description of Style

Victorian style buildings combine elements of 19th century rural farmhouse vernacular with more formal "high Victorian" examples found in Marin communities.

2. Typical Characteristics

Simple, rectilinear forms articulated with a regular pattern of openings

Vertically proportioned elements, including steeply pitched roofs, projecting gable ends, and tall cornices and parapets

Vertically proportioned windows, angled or boxed bays, and picture windows

Siding or stucco with shingled elements

Elements of Victorian Style – Multifamily Prototype

Note: The image below is intended to provide a reference for architectural elements and is illustrative, not regulatory. It is not an exhaustive list of applicable standards.

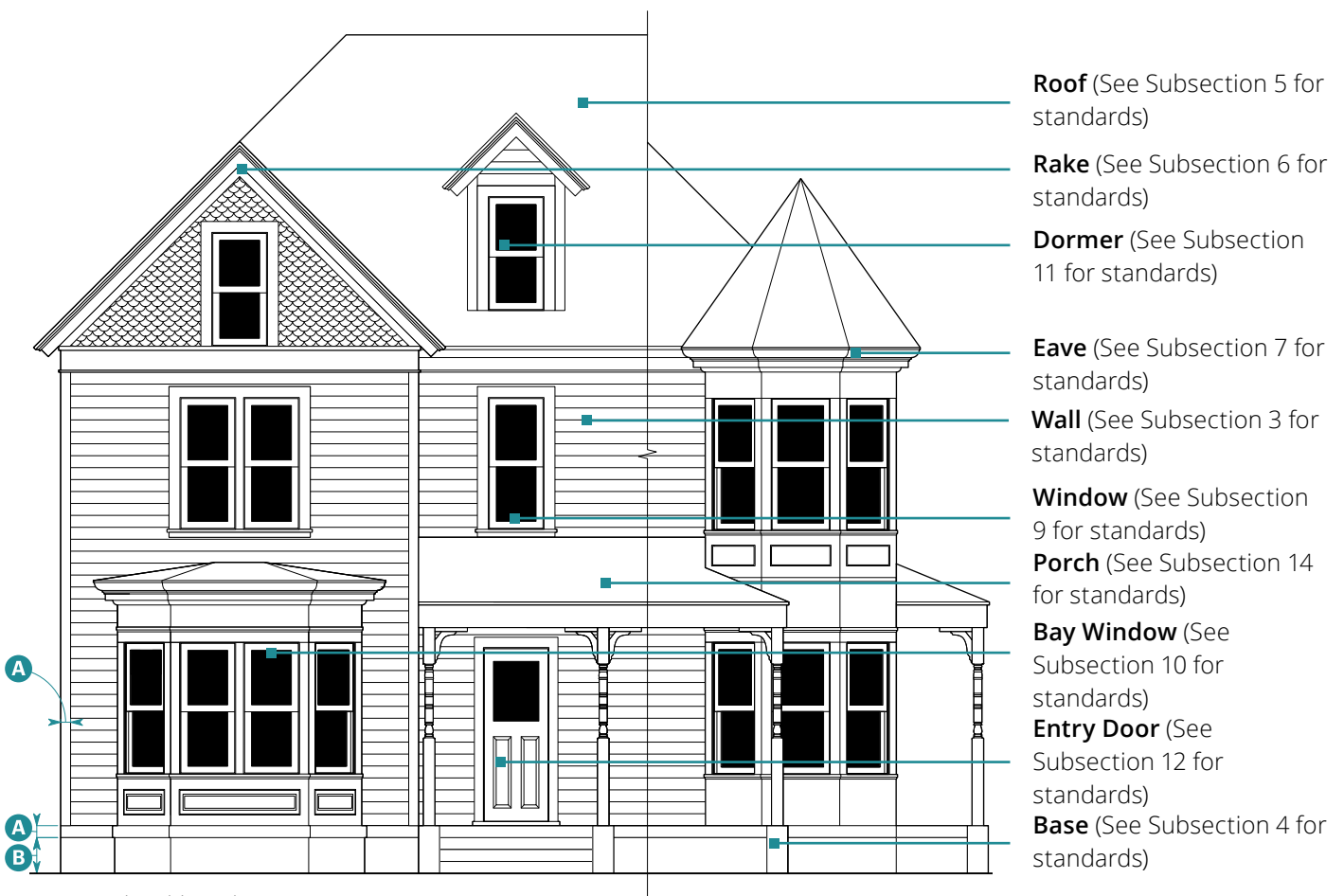

Prototypical Building Elevation

3. Wall	
Trim ¹	
Width	4" min.

¹ Corner trim required only on buildings with wood, composite wood, or cementitious siding wall material.

4. Base	
Height	1'0" min.; 2'0" max.

Elements of Victorian Style – Mixed-Use Prototype

Note: The image below is intended to provide a reference for architectural elements and is illustrative, not regulatory. It is not an exhaustive list of applicable standards.

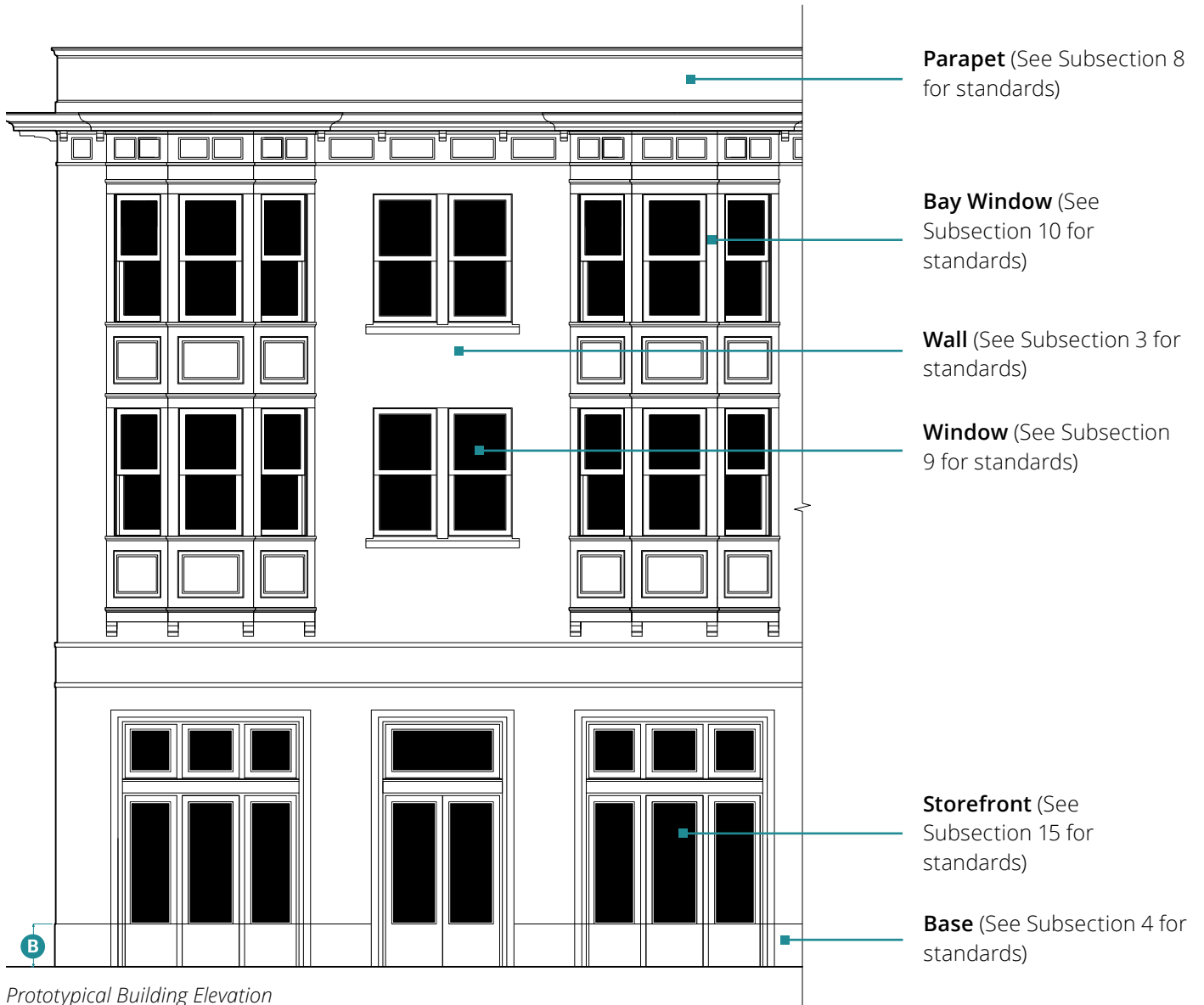

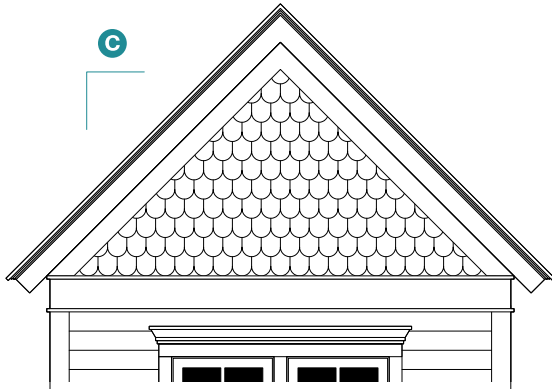

Gable End Elevation

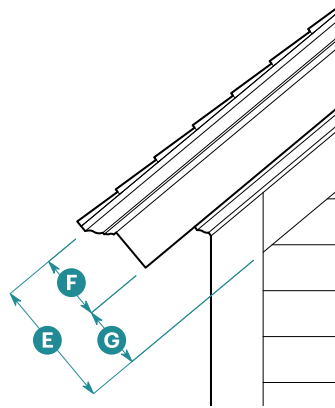

Open Eave Elevation

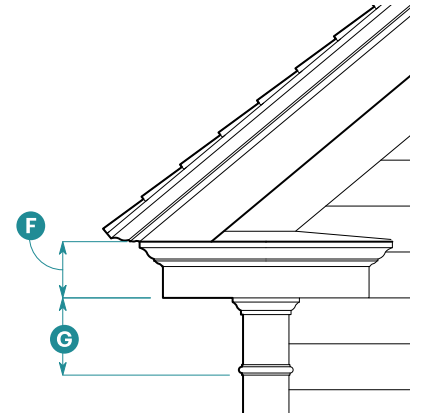

Returned Eave Elevation

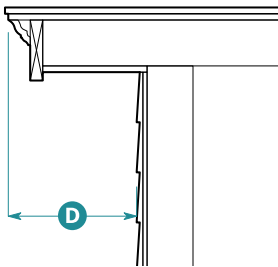

Rake Section

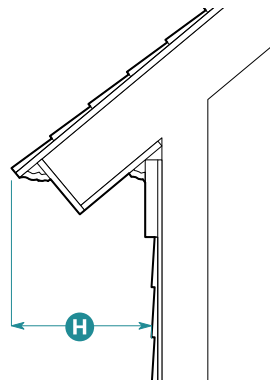

Open Eave Section

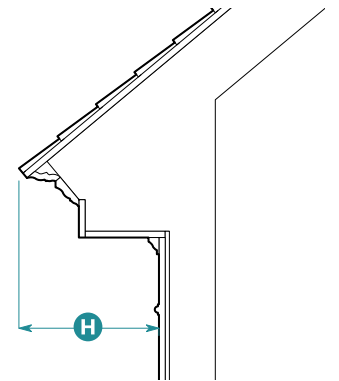

Returned Eave Section

5. Building Roof

Building Roof Standards	Buildings with Half-Story Heights	Buildings with Full-Story Heights
Roof Form		
Type	Sloped	Flat
Pitch	10:12	N/A

Applicable Subsections		
6. Rake	A	N/A
7. Eave	A	N/A
8. Parapet	N/A	A

Gable End Roof Form Standards		
Pitch	12:12 min.	C

6. Rake

Horizontal Projection	1'0" min.	D
-----------------------	-----------	----------

See Subsection 7 (Eave) for height standards.

7. Eave

Allowed Types

Eave Types	Open, Returned
------------	----------------

Height

Overall	1'6" min.	E
Crown Mold and Fascia	8" min.	F
Trim Band	10" min.	G

Horizontal Projection²

Overall	1'4" min.	H
---------	-----------	----------

²Horizontal projection includes gutter.

A = Applicable N/A = Not Applicable

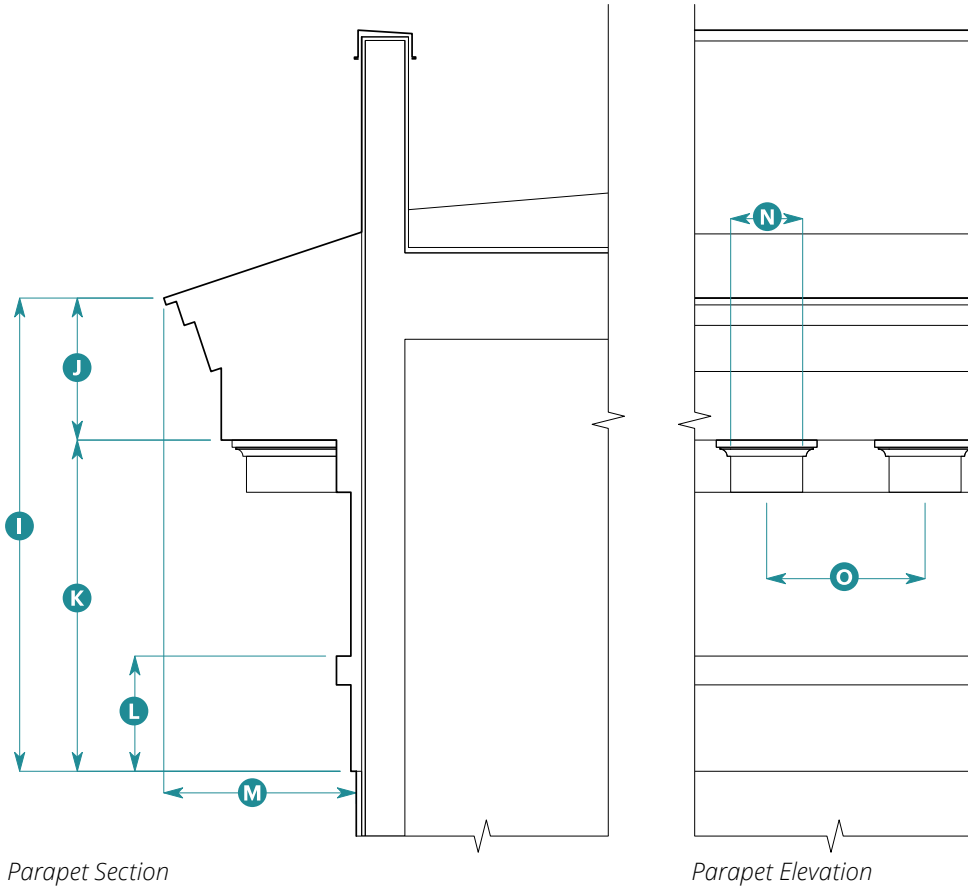

8. Parapet

Height

Overall	5'6" min.	I
Cornice	1'8" min.	J
Fascia		
Overall	3'6" min.	K
Lower Band	1'2" min.	L

Horizontal Projection³

Overall	2'6" min.	M
---------	-----------	---

Continuous cornice required on all street facing facades.

Required Ornament

Type	Dentils	
Width	10" min.	N
Spacing	24" max. on center	O
Placement	Below cornice at top of fascia	

³Horizontal projection includes gutter.

9. Windows

Opening

Proportion, Height **P** to Width **Q**⁴

Ground Floor	2.25 min.
Upper Floor	2.125 min.
Dormer	See Subsection 11 (Dormers) for standards.

Typical Sizes, Width **Q** x Height **P**

Ground Floor, Typical	2'8" x 6'6"
Ground Floor, Ganged	2'8" x 6'6"
Ground Floor, Picture	4'2" x 6'6"
Upper Floor, Typical	2'8" x 5'8"
Upper Floor, Ganged	2'8" x 5'8"
Upper Floor, Picture	4'2" x 5'8"
Privacy	2'0" x 4'6"
Shape	Square
Operation	Single Hung, Double Hung, Casement

Window

Glazing Divisions	2 over 2	
Frame Width (Frame + Sash)		
At Rail	2.5" min. ± 1/4"	R
At Stile	2.5" min. ± 1/4"	S
Trim Widths		
Head	4" min.	T
Jamb	4" min.	U
Apron	3" min.	V

Window Frame Recess

Depth	2" min.
-------	---------

Sill

Depth	3" min.
-------	---------

Pediment

Allowed	Yes
---------	-----

Mullions

Mullions required between ganged windows.

"Typical" refers to a regular recurring window (i.e., size or lite pattern) on a facade.

¹ Picture windows shall be wider than typical windows and equal in height to windows on the same floor.

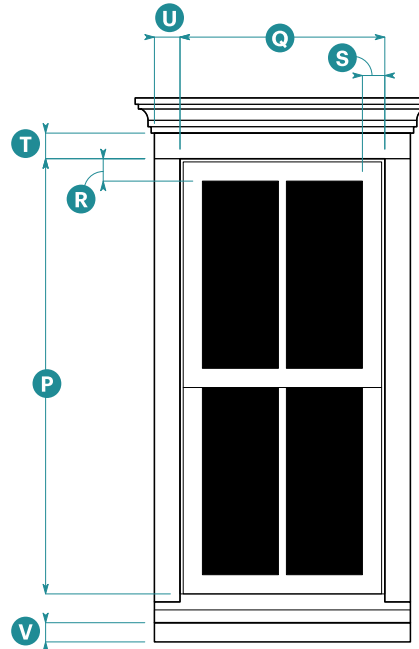

*Upper Floor Typical Window Elevation
2 over 2*

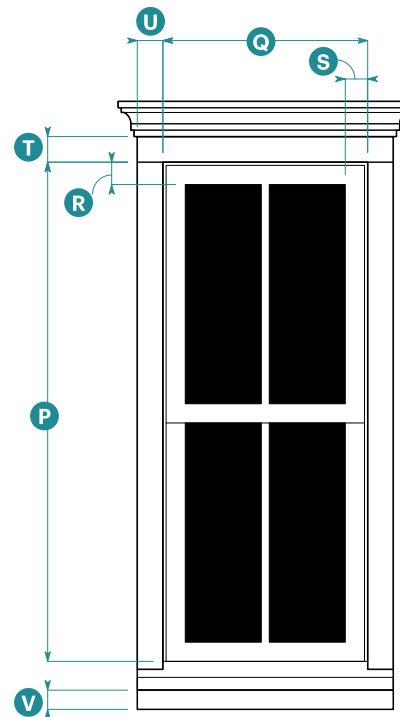

*Ground Floor Typical Window Elevation
2 over 2*

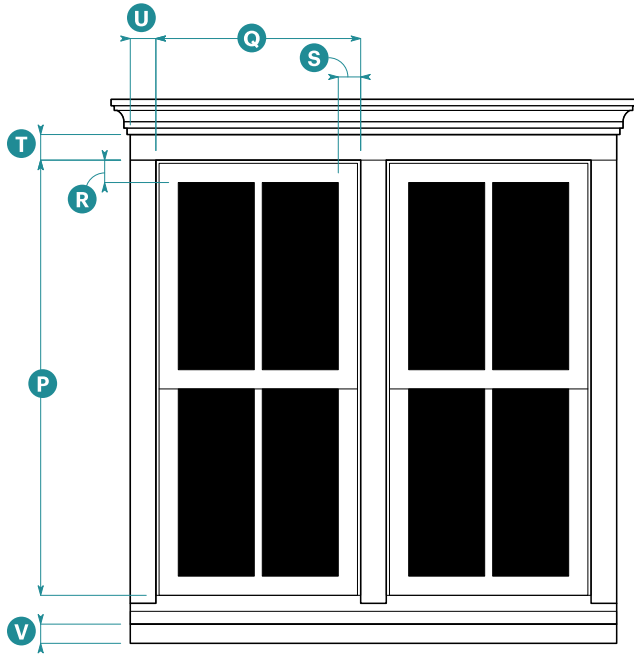

*Upper Floor Ganged Window Elevation
2 over 2*

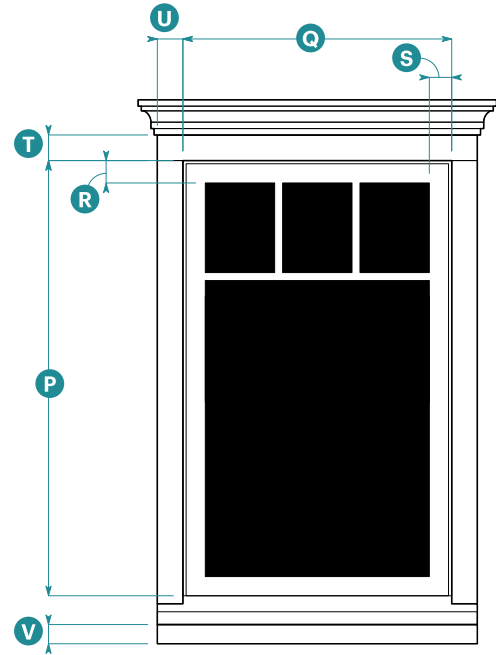

Upper Floor Picture Window Elevation

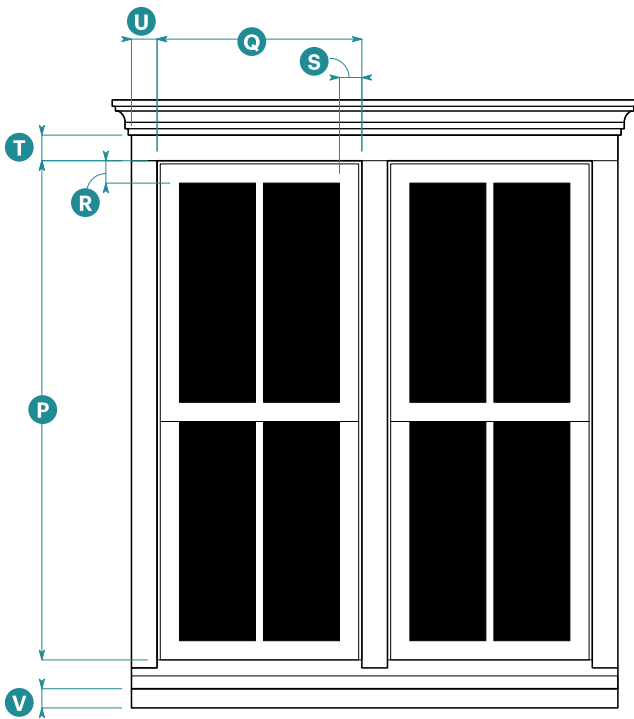

*Ground Floor Ganged Window Elevation
2 over 2*

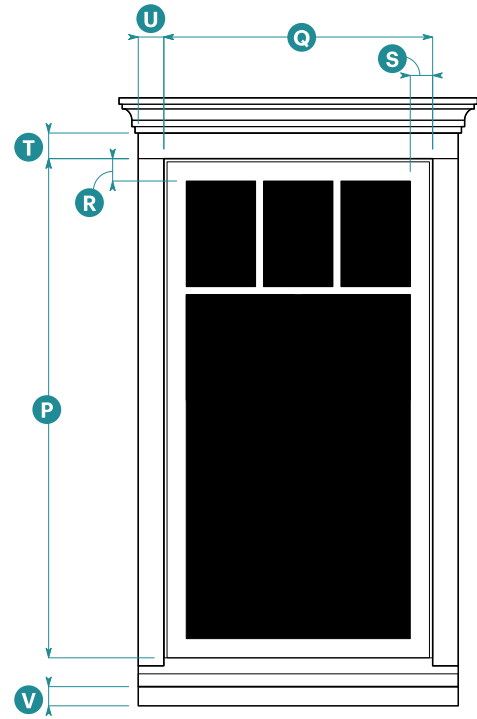

Ground Floor Picture Window Elevation



Bay Window Plan

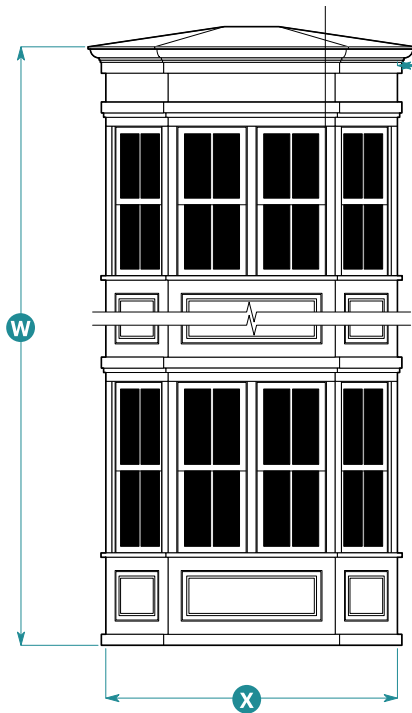

Bay Window Elevation

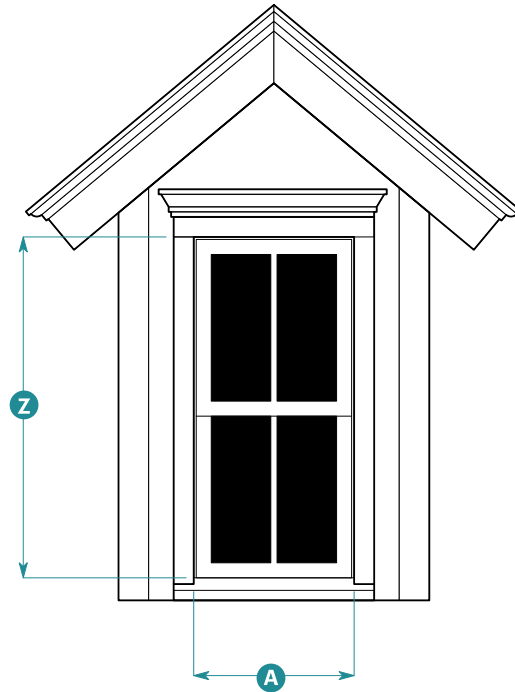

Dormer Elevation

10. Bay Windows

Form

Type	Chamfered
Interior Angle	30 degrees min.; 55 degrees max.
Number of Faces	3 or 5

Size

Height		W
On buildings with heights up to 3 stories	2 stories max.	
On buildings with heights above 3 stories	2 stories plus 1 additional story for each building story over 3 max.	
Width	6'0" min.; 12'0" max.	X
Depth	1'0" min.; 3'0" max.	Y

Cornice Types

- Cornice wraps bay.
- Bay stops below building cornice (bay has own cornice).
- Bay returns into building cornice (bay never projects above the building cornice).

10. Bay Windows (Continued)

Additional Standards

Bay depth not allowed to project beyond cornice depth.
 Multi-story bay window form shall be vertically continuous.
 Continuous horizontal articulation on building shall wrap bay form.

11. Dormers

Roof Form

Type	Gable
Pitch	10:12

Window

Proportion, Height to Width	2.125 min.	Z to A
Width	2'8" min.	A

Pediment

Allowed Yes
 See Returned Eave Elevation in Subsection 7 (Eave) for additional standards.
 Dormers allowed only for buildings with half stories.
 See Subsections 6 (Rake), 7 (Eave), and 9 (Windows) for additional standards.

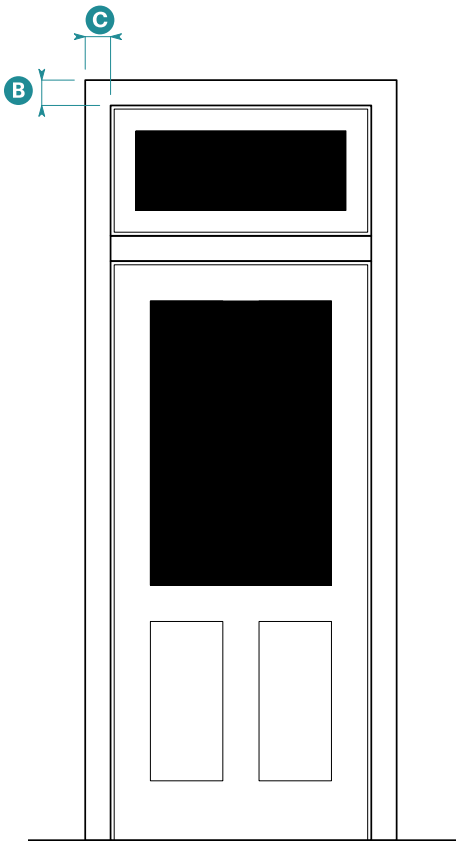

Entry Door Elevation

12. Entry Doors	
Door	
Number of Panels	2 min.
Surround	
Head Width	4" min. B
Jamb Width	4" min. C
Additional Elements	
Transom	Allowed
Pediment	Allowed

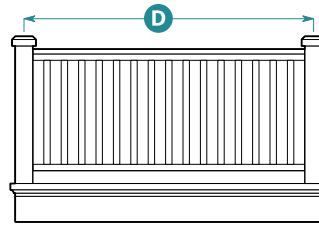

Type 1
Square Guardrail

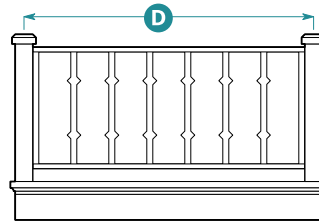

Type 2
Flat Sawn Guardrail

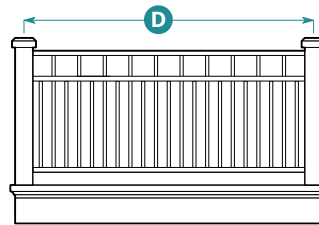

Type 3
Decorative Metal Guardrail

Balcony Front Elevation

13. Balconies	
Allowed Materials	
Type 1 - Square Guardrail	
Post, Baluster, Handrail, Fascia, and Brackets	Metal, composite wood, wood
Type 2 - Flat Sawn Guardrail	
Post, Baluster, Handrail, Fascia, and Brackets	Metal, composite wood, wood
Type 3 - Decorative Metal Guardrail	
Post, Handrail, Fascia, and Brackets	Metal, composite wood, wood
Baluster	Metal
Size	
Overall Balcony Width	10'0" max.
Width Between Posts	3' min. D

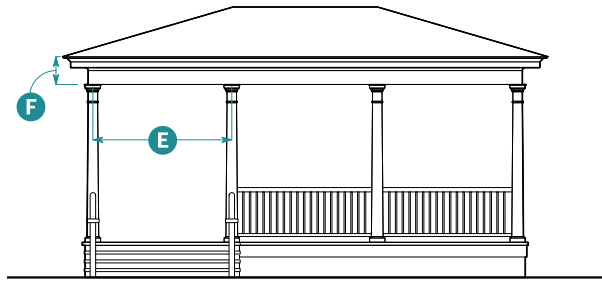

One-Story Porch

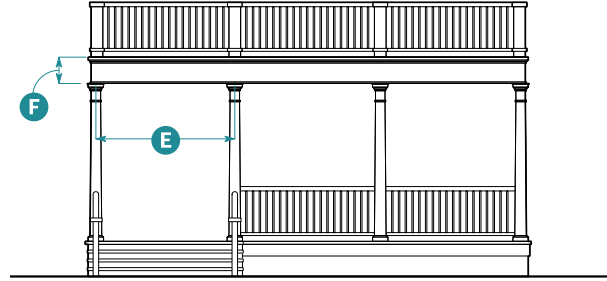

One-Story Porch with Deck Above

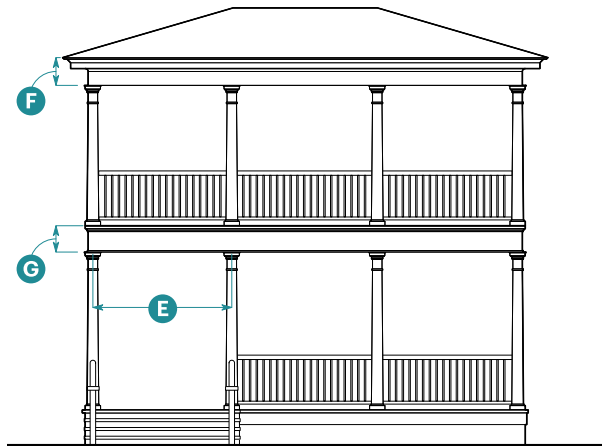

Two-Story Porch

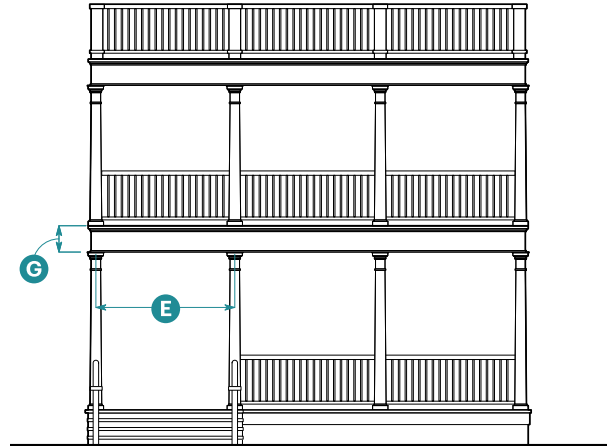

Two-Story Porch with Deck Above

14. Porches	
Columns	
Shape	Square-stock, square-tapered, or turned with brackets
Diameter	6" min.
Spacing	8'0" max. on center E
Entablature	
Height of Topmost Entablature	
Overall	1'6" min. F
Fascia	10" min.
Height of Floor-to-Floor Entablature	
Overall	10" min. G



Storefront Elevation

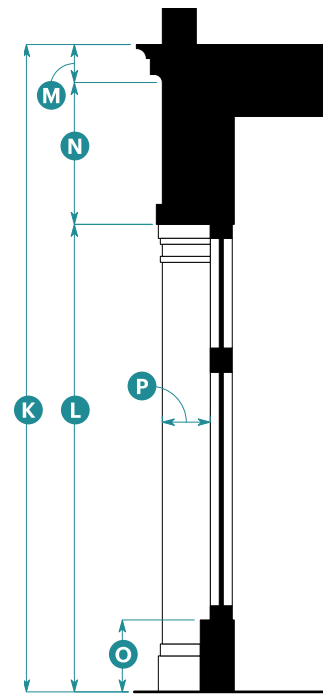

Storefront Section

15. Storefronts

Width

Storefront Module	10'0" min.; 15'0" max.	H
Display Window	3'0" min.; 4'0" max.	I
Distance Between Storefront Modules	1'0" min.; 2'0" max.	J

Height

Overall	13'0" min.	K
Head Height	10'0" min.	L
Cornice	9" min.	M
Signage Band	1'8" min.	N
Base	1'0" min.; 2'0" max.	O

Horizontal Recess

Depth	6" min.; 1'0" max.	P
-------	--------------------	---

Base shall be continuous, unless divided by pilaster, and align with base height of building (if any).

Cornice shall be continuous.

16. Materials	
Element	Allowed Materials
Wall	
Wall Cladding	
Sloped Roof Building	Shingle and lap siding: composite wood, wood, fiber cement
Flat Roof Building	Shingle and lap siding: composite wood, wood, fiber cement; and stucco
Base	
Base or Foundation	Brick, concrete, stone, stucco, composite wood, wood, fiber cement
Roof and Roof Elements	
Roofing	Asphalt shingles, wood shingles, standing seam metal
Rake and Eave	Composite wood, wood
Cornice	Composite wood, wood
Brackets	Composite wood, wood, fiberglass
Gutter	Metal ogee or half-round
Windows, Bay Windows, and Entry Doors	
Trim or Surround	Composite wood, wood, fiber cement
Entry Door	Wood, aluminum, fiberglass, composite
Window Frames	Wood, aluminum clad wood, aluminum, fiberglass
Glazing	Clear glass; shall not be tinted, mirrored, or colored
Balconies	
See Subsection 13 (Balconies) for allowed materials.	
Porches	
Columns	Composite wood, wood, fiberglass, metal
Railing	Composite wood, wood, metal
Storefronts	
Storefront	Composite wood, wood, metal
Storefront Base	Wood panels, brick, tile, fiber cement

Chapter 8: Specific to Large Sites

Sections:

08.010	Purpose
08.020	General to Walkable Community Design
08.030	Walkable Neighborhood Plan
08.040	General to Civic Space

08.010 Purpose

This Chapter establishes standards to create walkable neighborhoods.

1. Development subject to this Chapter is required to create and reinforce walkable neighborhoods with a mix of housing, civic, retail, and service uses within a compact, walkable, and transit-friendly environment.
2. Developments in compliance with this Section shall achieve the following goals:
 - A. Improve the built environment and human habitat;
 - B. Promote development patterns that support safe, effective, and multi-modal transportation options, including auto, pedestrian, bicycle, and transit;
 - C. Reduce vehicle traffic and support transit by providing for a mixture of land uses, highly interconnected block and street network, and compact community form;
 - D. Generate or reinforce neighborhoods with a variety of housing types to serve the needs of a diverse population;
 - E. Promote the health benefits of walkable environments;
 - F. Generate pedestrian-oriented and scaled neighborhoods where the automobile is accommodated but does not dominate the streetscapes;
 - G. Reinforce the unique identity of Marin and build upon the local context, climate, and history;
 - H. Realize development based on the patterns of existing walkable neighborhoods; and
 - I. Design that suits specific topographical, environmental, design site layout, and design constraints unique to the design site.

08.020 General to Walkable Community Design

1. Developments of at least three acres or at least 700 feet long or deep shall be designed per the following standards:
 - A. Developments of 20 acres or less, see Figure 1 (Walkable Neighborhood Plan Design Process Overview for Large Sites); or
 - B. Developments over 20 acres, see Figure 2 [Walkable Neighborhood Plan Design Process Overview for Large Sites (Over 20 Acres)]; and
 - C. **Walkable Neighborhood Plan (WNP).** Proposed development is required to include a Walkable Neighborhood Plan (WNP) in compliance with this Subsection that identifies the proposed and existing blocks, civic and open spaces, and streets within 1,500 linear feet of the proposed development. WNP's shall include the information required in Section 08.030 (Walkable Neighborhood Plan).
2. **Civic Space Required**
 - A. Civic space shall be provided in compliance with Section 08.040 (General to Civic Space).
 - B. A minimum of 10 percent of the total development area, after subtracting street right-of ways, is required.
3. **Streets.** Streets are to be applied to create walkable neighborhoods with redundant routes for vehicular, bicycle, and pedestrian circulation.
 - A. New streets are required to meet the standards in Chapter 24.04.I - Roads, including maximum slope.
 - B. Required streets, indicated on the WNP may be adjusted from their identified location by up to 100 feet in either direction.
 - C. The WNP shall identify the proposed street and block network.
 - D. Streets that pass from one zone to another may transition in their streetscape along the street's edges. For example, while a street within a more intense zone (e.g., T4CMS) with retail shops may have wide sidewalks with trees in grates, it may transition to a narrower sidewalk with a planting strip within a less intense zone (e.g., T4CN.M) with lower intensity residential building types.
4. **Alleys**
 - A. Existing alleys may be removed if street access is provided to the design sites on those blocks in compliance with the access standards of the zone.
 - B. Alleys may be added in compliance with WNP and Table A (Block Size Standards).
 - C. Design sites adjoining an alley and/or with a slope greater than six percent may be reduced in depth by up to 10 feet of the required depth. Rear setbacks may be reduced as allowed by Section 09.020 (Adjustment to Standards). Front setbacks shall not be reduced.

Figure 08.020.1: Walkable Neighborhood Plan Design Process Overview for Large Sites (3 to 20 Acres)

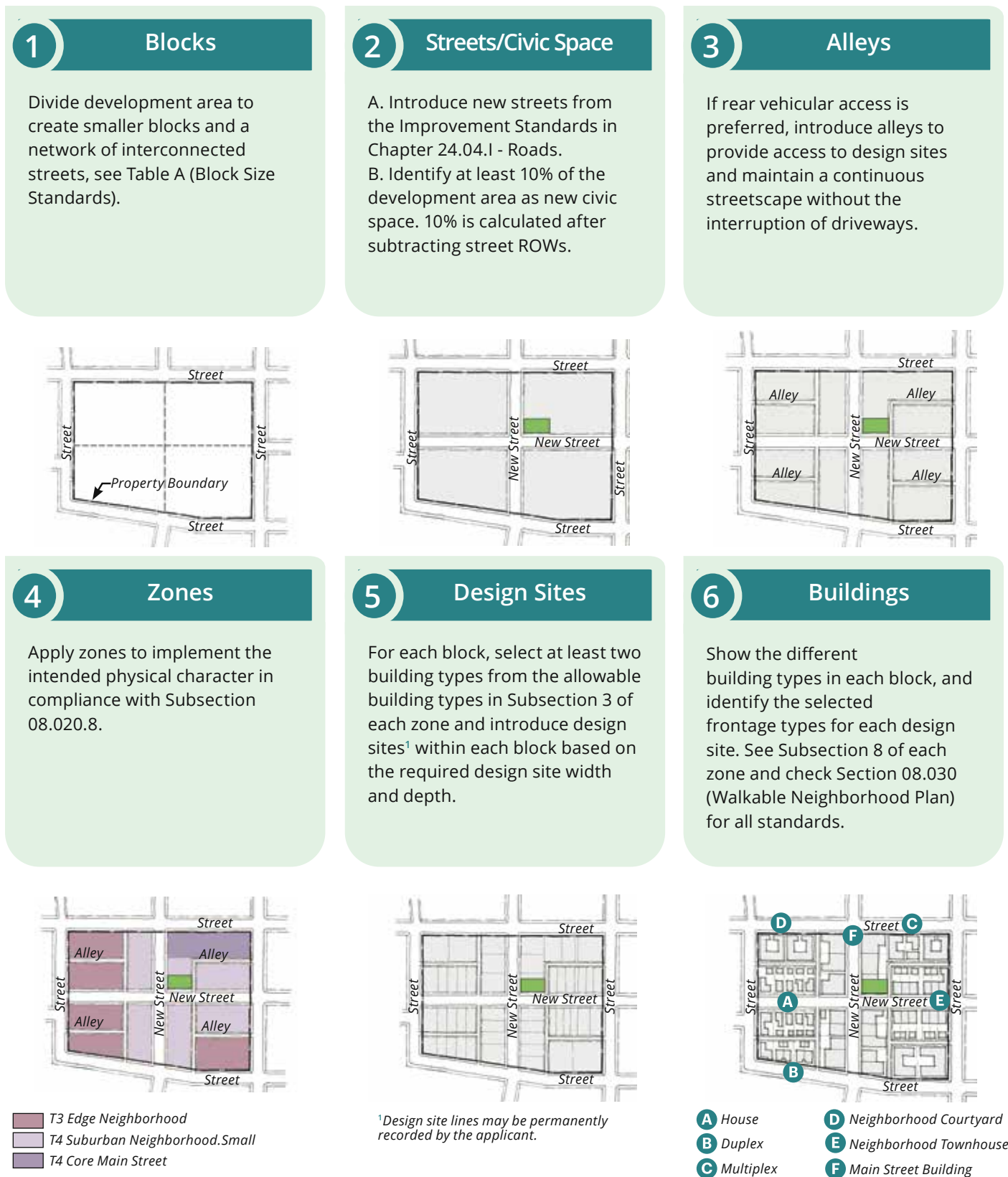

Figure 08.020.2: Walkable Neighborhood Plan Design Process Overview for Large Sites (Over 20 Acres)

1 Blocks

Divide development area to create smaller blocks and a network of interconnected streets, see Table A (Block Size Standards).

2 Streets/Civic Space

A. Introduce new streets from the Improvement Standards in Chapter 24.04.I - Roads.
 B. Identify at least 10% of the development area as new civic space. 10% is calculated after subtracting street ROWs.

3 Alleys

If rear vehicular access is preferred, introduce alleys to provide access to design sites and maintain a continuous streetscape without the interruption of driveways.

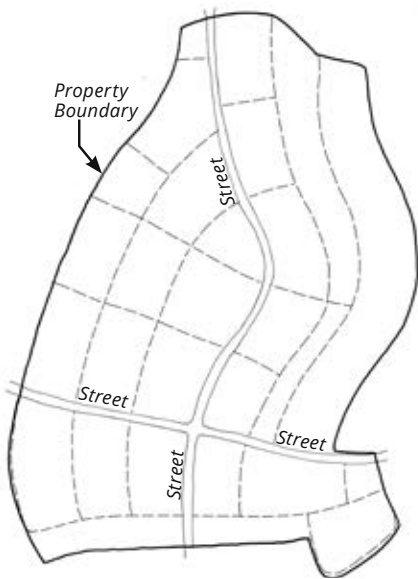

Existing Site

Development area with existing streets and superblocks

This diagram shows the starting point for the design process. It depicts a development area with a few main streets and large, irregular 'superblocks' that lack a fine-grained street network.

Figure 08.020.2: Walkable Neighborhood Plan Design Process Overview for Large Sites (Over 20 Acres) (Continued)

4 Zones

Apply zones to implement the intended physical character, in compliance with Subsection 08.020.8.

5 Design Sites

For each block, select at least two building types from the allowable building types in Subsection 3 of each zone and introduce design sites¹ within each block based on the required design site width and depth.

6 Buildings

Show the different building types in each block, and identify the selected frontage types for each design site. See Subsection 8 of each zone and check Section 08.030 (Walkable Neighborhood Plan) for all standards.



- T3 Edge Neighborhood
- T4 Suburban Neighborhood.Small
- T4 Core Neighborhood.Medium



¹Design site lines may be permanently recorded by the applicant.



- A House
- B Duplex
- C Cottage Court
- D Neighborhood Townhouse
- E Multiplex
- F Main Street Building

5. External Connectivity

- A. The arrangement of streets shall provide for the alignment and continuation of existing or proposed streets into adjoining lands where the adjoining lands are undeveloped and intended for future development, or where the adjoining lands are undeveloped and include opportunities for such connections.
- B. Street rights-of-way shall be extended to or along adjoining property boundaries to provide a roadway connection or street stub for development, in compliance with Table A (Block Size Standards), for each direction (north, south, east, and west) in which development abuts vacant land.
- C. Right-of-way stubs shall be identified and include a notation that all stubs are to connect with future streets on adjoining property and be designed to transition in compliance with WNP.
- D. New dead-end streets and cul-de-sacs are not allowed, except when the grade of the new street exceeds 15 percent.

6. Block Size (New Blocks and Blocks to be Modified)

- A. Individual block lengths and the total block perimeter shall be in compliance with the standards in Table A (Block Size Standards).
- B. If a block contains multiple zones, the most intense zone is to be used to establish the standards for block size.
- C. Blocks shall be a minimum width to result in two halves of developable design sites in compliance with the design site depth standards for the allowed building types in the zone. A single half is allowed when adjoining an existing half-block.
- D. Blocks shall be designed so that new streets and building sites conform with Section 04.050 (Slope Standards).
- E. Blocks may be uniquely shaped in compliance with the standards in Table A (Block Size Standards), and the allowed adjustments in Table 08.030.A (Adjustments to Standards for Design Sites Less Than 6% Slopes) and Table 08.030.B (Adjustments to Standards for Design Sites Over 6% Slopes).

Table 08.020.A: Block Size Standards

Zone	Length	Passage Required ¹	Perimeter Length
T3EN	900' max.	Yes	2,400' max.
T3SN	900' max.	Yes	2,400' max.
T4SN.S	600' max.	Yes	2,000' max.
T4CN.M	600' max.	Yes	2,000' max.
T4SMS.S	600' max.	Yes	2,000' max.
T4CMS	600' max.	No	2,000' max.
T5CN	400' max.	No	1,600' max.
T5CMS	400' max.	No	1,600' max.

¹In compliance with the standards for a Passage in Subsection 08.040.13 (Passage)

Figure 08.020.3 Block Size

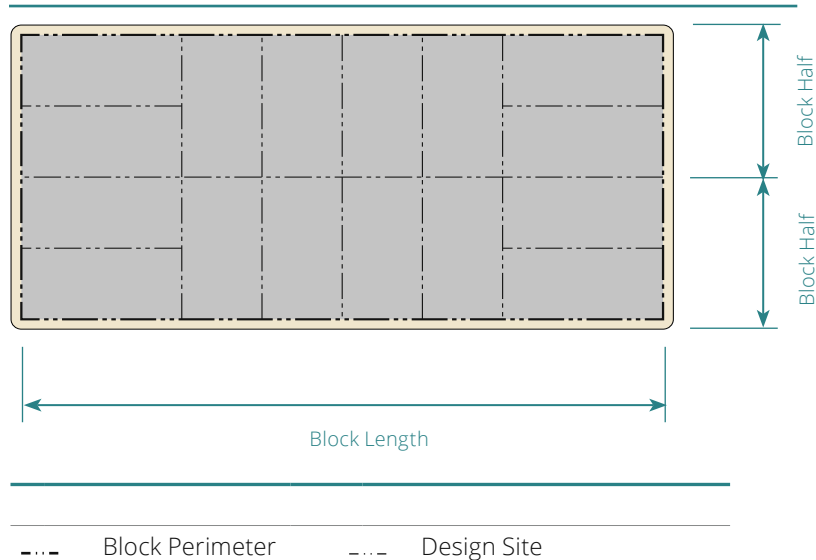

7. Stormwater Management

A. Integrated Design

- (1) Stormwater management is required through a system that is integral to the streetscapes and/or the civic and open space(s) in the development.
- (2) The WNP shall identify the area(s) being proposed for managing stormwater. These areas are required to be a combination of the following:
 - (a) Swale within a planted median;
 - (b) Swale within a continuous tree planter adjacent to the travel lane;
 - (c) Pond or other water body; and/or
 - (d) Areas within an allowed civic space type.
- (3) The area(s) used for stormwater management is to be designed for both seasonal temporary on-site retention of stormwater and as public open space for the neighborhood(s) accessible to the public.
- (4) The stormwater management area(s) may connect with those of adjacent development(s).

Figure 08.020.4 Stormwater Management Diagram

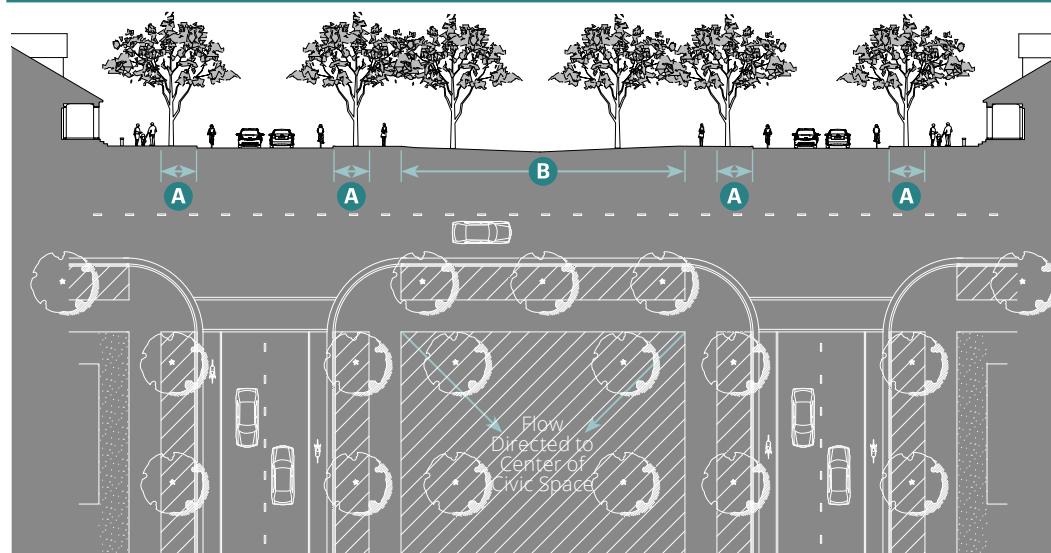



-  Potential Area for Stormwater Management
-  Planted Swale
-  Civic Space Graded to also Accommodate Stormwater

Table 08.020.B: Required Allocation Mix of Zones		
Zone	Minimum % of Land ¹	Maximum % of Land ¹
Walkable Development		Total to not exceed 100%
T3EN	None	10%
T3SN	None	15%
T4SN.S	10%	40%
T4CN.M	25%	40%
T4SMS.S	None	25%
T4CMS	10%	25%
T5CN	None	25%
T5CMS	None	20%
Walkable Development within 1,500 feet of transit stop²		Total to not exceed 100%
T3EN	None	5%
T3SN	None	10%
T4SN.S	30%	50%
T4CN.M	40%	70%
T4SMS.S	None	30%
T4CMS	None	25%
T5CN	None	40%
T5CMS	None	30%

¹ Net area after subtracting rights-of-way for streets and open/civic space

² A high-frequency transit stop with approximately 15-minutes between arriving buses

8. Applying Zones

- A. **Allocation of Zones.** The WNP shall map the proposed zones on the proposed blocks and any existing blocks in the development in compliance with the following:
 - (1) Sites less than three acres are required to apply one zone, using only the zones established in Chapter 3 (Zones); or
 - (2) Sites greater than three acres and up to 20 acres shall apply at least two zones using only the zones established in Chapter 3 (Zones); or
 - (3) Sites over 20 acres shall apply zones in compliance with the allocation mix standards in Table B (Required Allocation Mix of Zones).
- B. **Organization of Zones.** Zones shall be organized and mapped in a manner that responds appropriately to the various design site conditions. When applying or amending zone boundaries, more intense zones (i.e., T4SMS.S, T4CMS, and T5CMS) shall be organized around a neighborhood main street, civic or open space, transit stop, or civic building locations suitable for greater intensities. These areas shall not be located on slopes greater than six percent.
- C. **Transition between Zones.** Transitions between zones shall occur within the block or across alleys along the adjacent prevailing slope.

08.030 Walkable Neighborhood Plan

1. Walkable Neighborhood Plan (WNP) Standards

A. **Organization.** Each WNP is required to:

- (1) Identify the zone(s), civic space(s), street and block network, as allowed to be adjusted by Table 09.020.A (Adjustments to Standards); and
- (2) Be in compliance with the design standards of Section 08.020 (General to Walkable Community Design).

2. Required Content

A. **General.** Each WNP shall include the following information:

- (1) Boundaries of the proposed development;
- (2) Existing and proposed blocks within 1,500 linear feet of the development boundaries;
- (3) Open space not to be developed (if any);
- (4) Civic space, in compliance with Section 08.040 (General to Civic Space); and
- (5) Mapping of proposed zones in compliance with Subsection 08.020.8.

B. **Illustrative Site Plan**

- (1) The proposed physical character of the WNP shall be identified on an Illustrative Plan showing, in plan view, the proposed building types and private frontage types on each block and the proposed public frontage types showing proposed trees and landscaping along streets and in civic space types.
- (2) As individual needs of a development may change over time, the building types specified in the WNP may be substituted with other building types allowed by the zone in compliance with the zone standards.

3. Required Mix of Building Types and Private Frontage Types

- A. Except in the T4CMS and T5CMS zones, the WNP shall maintain a mix of at least two different building types and two different private frontage types within each block, using only the types allowed in the zone(s).
- B. The WNP shall maintain a mix of at least two different architectural styles within each block.
- C. The WNP shall show dimensioned block depths for both halves of each block to demonstrate compliance with the minimum design site depth required for the building types in each zone.
- D. The applicant may choose to show the shortest minimum design site depth allowed in each zone with an acknowledgement that the selected depth may not accommodate the full range of building types allowed by the zone.

08.040 General to Civic Space

1. The WNP shall identify open spaces and civic space types in compliance with the following standards and the standards of Table A (Civic Space Types Overview).
2. When hillsides are within the development, the hillside ridge(s) shall be the location for civic and open space.
3. Required civic and open space identified on the WNP may be adjusted from its identified location by up to 100 feet in any direction.
4. Public access and visibility is required along public parks, natural open spaces, and civic uses, including creeks and drainages and stormwater management areas, and shall be fronted by:
 - A. Single-loaded frontage streets (those with development on one side and open space on the other);
 - B. Bike and pedestrian paths; or
 - C. Other methods of frontage that provide similar access and visibility to the open space allowed in the zone. Such access may be provided through public easements or other similar methods.
5. **Amount of Civic Space Required.** As required by Subsection 08.020.2, development design sites are required to set aside a minimum area of the design site as civic space. One or more civic spaces may be used to meet the required area.
6. **Building Frontage Along or Adjacent to a Civic Space.** The facades on building design sites attached to or across a street from a civic space shall be designed as a "front" on to the civic space, in compliance with Subsection 5 and Subsection 8 of the zone.
7. **Civic Space Types Overview.** This Subsection identifies the allowed civic space types and standards for improvements to existing civic spaces and for construction of new civic spaces. For each civic space type, Subsection 1 and Subsection 3 are regulatory, and Subsection 2 and Subsection 4 are non-regulatory. Allowed civic space types are identified in Table A (Civic Space Types Overview).

Table 08.040.A: Civic Space Types Overview

	Specific Standards	Zones							
		T3		T4				T5	
		EN	SN	SN.S	CN.M	SMS.S	CMS	CN	CMS
Greenway	08.040.8	P	P	P	P	X	X	P	X
Green	08.040.9	P	P	P	P	X	X	P	X
Plaza	08.040.10	X	X	X	X	P	P	X	P
Playground	08.040.11	P	P	P	P	P	P	P	P
Community Garden	08.040.12	P	P	P	P	P	P	P	P
Passage	08.040.13	P	P	P	P	P	P	P	P

Key P = Allowed X = Not Allowed

8. Greenway



1. Description

A multiple-block long linear space for community gathering and strolling for nearby residents and employees, defined by a tree-lined street on at least one side, sometimes forming a one-way couplet on its flanks and by the fronting buildings across the street. Greenways serve an important role as a green connector between destinations.

2. General Character

Formal or informal dominated by landscaping and trees with integral stormwater management capacity

Hardscape path

Spatially defined by tree-lined streets and adjacent buildings

3. Size and Location

Size 2 continuous blocks in length, min.

Width 60' min.

Shall front at least one street

4. Typical Uses

Uses as allowed by the Zone

9. Green



1. Description

A large space available for unstructured and limited amounts of structured recreation.

2. General Character

Formal or informal with integral stormwater management capacity

Primarily planted areas with paths to and between recreation areas and civic buildings

Spatially defined by tree-lined streets and adjacent buildings

3. Size and Location

Size 300' x 300' min.

Street required on at least one side of the Green.

Facades on design sites attached to or across a street shall "front" on to the Green.

4. Typical Uses

Uses as allowed by the Zone

10. Plaza



1. Description

A community-wide focal point primarily for civic purposes and commercial activities.

2. General Character

Formal, urban

Hardscaped and planted areas in formal patterns

Spatially defined by buildings and tree-lined streets

3. Size and Location

Size 50' x 50' min.

Street required one of the Plaza's sides.

Facades on design sites attached to or across a street shall "front" on to the Plaza.

4. Typical Uses

Uses as allowed by the Zone

11. **Playground**



1. Description

A small-scale space designed and equipped for the recreation of children. These spaces serve as quiet, places protected from the street and in locations where children do not have to cross any major streets. An open shelter, play structure(s), or interactive art and fountain(s) may be included. Playgrounds may be included within all other civic space types except Community Garden.

2. General Character

Play structure(s), interactive art, and/or fountain(s)

Shade and seating provided

May be fenced

Spatially defined by trees

3. Size and Location

Size 40' x 60' min.

4. Typical Uses

Uses as allowed by the Zone

12. Community Garden



1. Description

A small-scale space designed as a grouping of garden plots available for small-scale cultivation. Community gardens may be fenced and may include a small accessory structure for storage. Community Gardens may be included within all other civic space types except Playgrounds.

2. General Character

- Informal or Formal, urban

- Combination of planted areas and hardscape

- Spatially defined by building frontages and adjacent street trees

- Walkways along edges or across space

3. Size and Location

Size No minimum; within any design site as allowed by the zone

4. Typical Uses

Uses as allowed by the Zone

13. **Passage**



1. Description

A pedestrian pathway that extends from the public sidewalk into a civic space and/or across the block to another public sidewalk. The pathway is lined by non-residential shopfronts and/or residential ground floors and pedestrian entries as required by the zone.

2. General Character

- Formal, urban
- No accessory structure(s)
- Primarily hardscape with landscape accents
- Spatially defined by building frontages
- Trees and shrubs in containers and/or planters

3. Size and Location

- Size 20' min. clear width between or through buildings
- Ground floor facades shall be in compliance with facade zone in Subsection 5 and frontages allowed in Subsection 8 of the zone.
- Dooryards, porches, patios, and sidewalk dining shall not encroach into the minimum required width.

4. Typical Uses

Uses as allowed by the Zone

This page intentionally left blank

Chapter 9: Adjustments

Sections:

09.010	Purpose
09.020	Procedures

09.010 Purpose

1. This Chapter allows for minor deviations from certain standards in this FBC for specific situations because of the prescriptive nature of the standards.
2. Section 09.030 (Adjustments to Standards) identifies the situations eligible for deviation(s) from the standards subject to required findings.
3. Design standards from state law(s) that are more restrictive prevail over the FBC standards and shall not be adjusted.

09.020 Procedures

1. Adjustment requests shall be reviewed and processed as follows:
 - A. The Review Authority shall grant an Adjustment for only the standards identified in Tables A and B.
 - (1) Table A contains the situations eligible for adjustments and the required findings for lots with less than six percent slope.
 - (2) Table B contains the situations eligible for adjustments and the required findings for lots with more than six percent slope.
 - B. If the development for which an Adjustment is requested meets the required findings, the identified Administrative Relief shall be granted. The Adjustment shall be processed concurrently with the County's application processing requirements identified in Section 22.14.100 [Form-Based (FB) Combining Districts].
2. Adjustment requests involving any of the following features (i.e., trees, rock outcrop, historic building/feature, and/or utility infrastructure) shall be accompanied by existing conditions documentation identifying the feature(s).
3. Depending on the unique characteristics and dimensions on an individual parcel, it is possible that the full development potential of the zone may not be achievable even after applying the allowed adjustments in this Section.

Table 09.020.A: Adjustments to Standards for Design Sites Less Than 6% Slopes

Administrative Relief Type	Required Findings	Allowed Administrative Relief	Reference to Standard
1. Design Site Dimensions			
a. Depth or Width Decrease in the minimum required or maximum allowed	i. An existing historic building/feature, tree, rock outcrop, and/or utility infrastructure prevents compliance with the standard.	Up to 10% of the standard	Subsection 3 of the zone
	ii. An existing or new design site can be developed consistent with the intent of the zone as described in Subsection 1 of the zone.		
2. Building Setbacks			
a. Front, Side Street, Side or Rear Increase or decrease in the minimum to maximum required setback for a primary building and/or wing(s)	i. An existing historic building/feature, tree, rock outcrop, and/or utility infrastructure prevents compliance with the standard.	Up to 25% of the standard	Subsection 5 of the zone
	ii. The existing lot is 80' or less in depth, preventing compliance with the rear setback standard.		
	iii. An existing or new design site can be developed consistent with the intent of the zone as described in Subsection 1 of the zone.		
b. Facade within Facade Zone Reduction of the minimum amount of facade required within or abutting the facade zone	i. An existing historic building/feature, tree, rock outcrop, and/or utility infrastructure prevents compliance with the standard.	Up to 25% of the standard	Subsection 5 of the zone
	ii. An existing or new design site can be developed consistent with the intent of the zone as described in Subsection 1 of the zone.		
	iii. The horizontal unbuilt area resulting from this adjustment is landscaped per the standards in Section 04.030 (Landscaping and Lighting).		

Standards for private frontage apply [See Chapter 6 (Private Frontage Type Standards)], and any adjustment shall not preclude the application of a private frontage type.

Table 09.020.A: Adjustments to Standards for Design Sites Less Than 6% Slopes (Continued)

Administrative Relief Type	Required Findings	Allowed Administrative Relief	Reference to Standard
3. Building Footprint			
a. Size of Main Body or Wing(s) Increase in the allowed width or length	i. An existing historic building/feature, tree, rock outcrop, and/or utility infrastructure prevents compliance with the standard. <hr/> ii. An existing or new design site can be developed consistent with the intent of the zone as described in Subsection 1 of the zone. <hr/> iii. The wing(s) is one-story less in height than the main body. <hr/> iv. The building complies with the setbacks of the zone or as allowed to be adjusted by this Section.	Up to 10% of the standard	Subsection 3 of the building type
4. Parking Location			
a. Front or Side Street Setback Reduction in the required parking setback	i. An existing historic building/feature, tree, rock outcrop, and/or utility infrastructure prevents compliance with the standard. <hr/> ii. An existing or new design site can be developed consistent with the intent of the zone as described in Subsection 1 of the zone. <hr/> iii. The driveway is in compliance with the zone standards. <hr/> iv. The ground floor space remains habitable in compliance with the zone standards, as allowed to be adjusted by this Section.	Up to 10% of the standard when the required setback is 15' or more.	Subsection 7 of the zone
		Up to 20% of the standard when the required setback is less than 15'.	Subsection 3 of the zone

Standards for private frontage apply [See Chapter 6 (Private Frontage Type Standards)], and any adjustment shall not preclude the application of a private frontage type.

Table 09.020.B: Adjustments to Standards for Design Sites Over 6% Slopes

Administrative Relief Type	Required Findings	Allowed Administrative Relief	Reference to Standard
1. Design Site Dimensions			
a. Depth Increase or decrease in minimum to maximum design site depth	<ul style="list-style-type: none"> i. Existing slope exceeds 15% grade for at least 50% of design site depth. ii. If an adjustment is granted for an increase in the Main Body and Rear wing resulting in the need to change the development site depth, the development site depth may increase as allowed in this Section. iii. An existing or new design site can be developed consistent with the intent of the zone as described in Subsection 1 of zone. 	Up to 25% max. of the standard	Subsection 3 of the zone
b. Width Increase or decrease in minimum to maximum design site width	<ul style="list-style-type: none"> i. Existing slope exceeds 15% grade for at least 25% of design site width. ii. An adjustment granted for an increase in the main body and rear wing results in needing to change the development site depth by up to 25%. iii. An existing or new design site can be developed consistent with the intent of the zone as described in Subsection 1 of the zone. 	Up to 20% max. of the standard	Subsection 3 of the zone
2. Building Setbacks			
a. Front, Side Street, Side or Rear Increase or decrease in minimum to maximum required setback areas for primary building and/or wing(s)	<ul style="list-style-type: none"> i. Existing slope exceeds 20% within at least the first 30' of site depth. ii. An existing historic building/feature, tree, rock outcrop, and/or utility infrastructure prevents compliance with the standard. iii. An existing or new design site can be developed consistent with the intent of the zone as described in Subsection 1 of the zone. iv. The existing lot depth is less than 80'. 	<p>Increase in the maximum setback to within 5' of the design site line. Where side street setback is 5' minimum, reduction in the minimum setback to within 3' of the design site line.</p> <p>Reduction in the maximum front setback up to 30' from the front design site line.</p>	Subsection 5 of the zone

Standards for private frontage apply [See Chapter 6 (Private Frontage Type Standards)], and any adjustment shall not preclude the application of a private frontage type.

Table 09.020.B: Adjustments to Standards for Design Sites Over 6% Slopes (Continued)

Administrative Relief Type	Required Findings	Allowed Administrative Relief	Reference to Standard
3. Building Footprint			
a. Size of Main Body or Wing(s) Increase in the allowed width or length	i. Existing slope exceeds 15% grade for at least 50% of the design site width or depth. ii. An existing or new design site can be developed consistent with the intent of the zone as described in Subsection 1 of the zone. iii. The building is in compliance with the setbacks of the zone or as allowed to be adjusted by this Section.	Up to 25% of the standard	Subsection 3 of the building type
4. Site Grading			
a. Retaining Wall (Height) Increase in maximum retaining wall height or length	i. Existing slopes exceed 20% grade for at least 50% of the design site width or depth. ii. The retaining wall or series of retaining walls cannot be seen from the adjacent public sidewalk or adjacent property. iii. Retaining walls not within the building footprint are less than 50' in total length along the rear design site line or any design site line.	Increase in retaining wall height up to 15' along rear and/or side design site line(s); Increase in retaining wall height up to 20' within the building footprint	Subsection 04.050.5
5. Block Face and Perimeter			
a. Length Increase in maximum length of new or modified block	i. Existing slope along at least one side of the block exceeds 15% grade, resulting in new street(s) that exceeds maximum allowed grade, preventing compliance with the standards.	Up to 25% of the standard	Table 08.020.A (Block Size Standards)

Standards for private frontage apply [See Chapter 6 (Private Frontage Type Standards)], and any adjustment shall not preclude the application of a private frontage type.

Table 09.020.B: Adjustments to Standards for Design Sites Over 6% Slopes (Continued)

Administrative Relief Type	Required Findings	Allowed Administrative Relief	Reference to Standard
6. Parking Location Setbacks			
a. Front or Side Street Reduction in a required parking setback.	One or more of the following techniques are applied, as allowed by this Section:		
	i. Surface: Parking is uncovered and located between the building and the street due to existing lot depth that is less than 80' preventing compliance with the parking setbacks location.	Front Setback: The parking location setbacks standards do not apply. Only one parking space allowed in the front setback along either side of the development site, for up to 6 parking spaces. Other parking spaces must be tandem.	Subsection 7 of the zone; Subsection 4 of the zone
	ii. Podium: Parking under primary building is enclosed and access is only from one side of the development site for development sites 150' or less in width. Habitable space, in compliance with Subsection 4 of the zone as allowed to be reduced by this Section, is between the front of the building and the parking spaces. The parking garage access is not greater than 10' in width.	Front Setback: Reduction to 18' behind the primary building facade. Side Street Setback: Reduction to 5' behind the primary building facade.	
	iii. Tandem Parking: Tandem parking spaces may be arranged in a series of up to 6 total parking spaces, but only up to 3 side-by-side, from the front development site line.	Habitable Space: Reduction in the minimum depth to 15'.	
	iv. Subterranean Parking: Parking spaces are located below the adjacent finished grade of the building to the zone's building setbacks.	All Setbacks: Reduced to match the building setbacks of the zone or as allowed to be adjusted by this Section.	
	v. Stacked Parking System: Parking spaces are arranged in a system that provides up to 3 spaces in the horizontal area of one space. The garage access is not greater than 10' in width.	Front and/or Side Street Setback: Reduced to be the same as the primary building setback. Reduction in the minimum habitable space depth to 18'.	

Standards for private frontage apply [See Chapter 6 (Private Frontage Type Standards)], and any adjustment shall not preclude the application of a private frontage type.

Chapter 10: Definitions

Sections:

10.010	Purpose
10.020	Definitions
10.030	Measurement Methods

10.010 Purpose

This Chapter provides definitions for specialized terms and phrases used in this FBC. All other applicable definitions in Chapter 22.130 (Definitions) apply.

10.020 Definitions

A. Definitions

Abutting. Having a common property line or district boundary, or separated by a private or public street or easement.

Access or Service Drive. A public or private way of paving or right-of-way of not more than 30 feet affording means of access to property.

Access Frontage or Service Road or Street. A public or private street or right-of-way of not less than minimum standards as specified by the subdivision ordinance of the County affording means of access to property.

Accessory Dwelling Unit (ADU). An attached or detached residential dwelling unit which provides complete living facilities for one or more persons, including permanent provisions for living, sleeping, eating, cooking, and sanitation, which is located on the same parcel as a single-unit dwelling.

Accessory Structure (syn. Accessory Building). A structure physically detached from, secondary and incidental to, and commonly associated with a primary structure or use on the same site. Accessory structures normally associated with a residential use property include, but are not limited to: garages (unenclosed or enclosed) for the storage of automobiles (including incidental restoration and repair), personal recreational vehicles, and other personal property; studios; workshops; greenhouses (noncommercial); enclosed cabanas and pool houses; and storage sheds. Accessory structures normally associated with a non-residential use property include, but are not limited to: garages (unenclosed or enclosed) for the storage of automobiles and work related vehicles and equipment (including incidental restoration and repair); storage structures; workshops; and studios.

Accessory Structure, Major (Major Accessory Structure). An accessory structure with a footprint greater than 120 square feet.

Accessory Structure, Minor (Minor Accessory Structure). An accessory structure with a footprint of 120 square feet or less.

Addition. The enlargement of an improvement accomplished by appending a new improvement.

Adjacent. Sharing a common design site line, or having design site lines separated only by an alley.

Adjacent Buildings. Two or more buildings located upon adjacent design sites.

Advisory Agency. The County staff member or County policy-making or review authority responsible for acting on an application.

Alley. A public or private way to be used primarily for vehicular access to the back or side of a design site of real property that otherwise abuts a street.

Alter. To create physical change in the internal arrangement of rooms or the supporting members of a structure, or a change in the external appearance of any structure, not including painting.

Amusement Center or Facility. A place of amusement, recreation, or entertainment, involving assemblages of people.

Ancillary Structure (syn. Ancillary Building). See "Accessory Structure."

Apartment, Efficiency. A dwelling unit in a multi-unit building, consisting of not more than one habitable room, excluding the kitchen or kitchenette and sanitary facilities, of a total floor area of not more than 400 square feet.

Applicant. Any individual, firm, or any other entity that applies to the County for the applicable permits to undertake any construction or development within the County.

Architectural Feature. Exterior building element intended to provide ornamentation to the building massing including, but not limited to: eaves, cornices, bay windows, window and door surrounds, light fixtures, canopies, and balconies. Architectural features does not include floor area. A window opening that includes an opening on each side.

Attached Building or Structure. Any building or structure which is structurally a part of or has a common wall and/or continuous roof with a primary building or structure, except where such connection is a breezeway or walkway incidental to and not a necessary part of the construction of the primary building.

Average Slope. The result of dividing the length of a slope by the difference in elevation at the top and bottom of the slope. See Section 10.030.1.C for measurement methods.

Awning. A roof or cover which projects from a wall of a building over a window or door, made of canvas, aluminum, or similar material, which may be fixed in place or be retractable.

B. Definitions

Base Flood Elevation. As designated by Federal Emergency Management Agency (FEMA), the elevation of surface water resulting from a flood that has a one percent chance of equaling or exceeding that level in any given year.

Basement. A story whose floor is more than 12 inches, but not more than half of its story height below the average level of the adjoining finished grade (as distinguished from a "cellar," which is a story more than one-half below such level). A basement, when used as a dwelling, shall not be counted as a story for purposes of height measurement.

Bathroom. A room that contains all of the following features: a bathtub or shower, a washbowl, and a toilet.

Bay. A division of a building as defined by solid vertical elements at its boundaries, especially the portion included between two consecutive supports. Openings such as windows and doors may appear within each facade bay. See Subsection 10.030.4 for measurement method.

Bay Window. An architectural projection from the building cantilevered from the facade, consisting of one or more stories in height, containing at least 60 percent glass area.

Block. An area of land separated from other areas by adjacent streets, railroads, rights-of-way, public areas, or the subdivision boundary.

Block Face. The aggregate of all the building facades on one side of a block. The block face provides the context for establishing architectural harmony.

Block Length. The horizontal distance from the right-of-way on one end of the block to the right-of-way on the other end along the same street.

Block Perimeter. The aggregate of all sides of a block bounded by the abutting rights-of-way.

Block-Scale, Building. A building that is individually as large as a block or individual buildings collectively arranged along a street to form a continuous facade as long as most or all of a block.

Building. A structure consisting of one or more foundations, floors, walls, and roofs that surround an interior space, and may include exterior appurtenant structures including, but not limited to, porches and decks.

Buildable Area. The horizontal area in which a building is allowed to be constructed.

Building Elevation. The exterior wall of a building not adjacent to a public right-of-way, the front or side along a private street, or civic space.

Building Entrance. A point of pedestrian ingress and egress to the front of a building along the sidewalk of the street immediately adjacent to the building.

Building, Existing. See "Structure, Existing."

Building Facade. The exterior wall of a building adjacent to a street, the front or side along a private street, or civic space.

1. **Building Facade, Front.** The exterior wall of a building adjacent to a street or civic space.
2. **Building Facade, Side Street.** The exterior wall of a building adjacent to a side street.
3. **Building Facade, Interior Side.** The exterior wall of a building adjacent to the interior design site line(s).
4. **Building Facade, Rear.** The exterior wall of a building opposite the front.

Building Form. The overall shape and dimensions of a building.

Building Frontage. The facade(s) along the front and side street of the design site.

Building Frontage, Principal. The facade along the front of the design site, typically the narrower of sides and identified by an address.

Building, Primary. The building that serves as the focal point for all activities related to the principal use of the design site.

Building, Setback. See "Setback, Building."

Building Type. A structure defined by its combination of configuration, disposition, and function.

By-Right, Approval. Approval by administrative staff of certain uses, improvements, and developments not requiring further review and in compliance with all applicable standards.

C. Definitions

Carriage House. A second permanent dwelling that is accessory to a primary dwelling on the same site. A carriage house provides complete, independent living facilities for one or more persons, including permanent provisions for living, sleeping, eating, cooking, sanitation, and parking, and if attached to the primary dwelling, is provided exterior access separate from the primary dwelling. See Section 05.040 (Carriage House).

Carshare Parking Space. A parking space required to be dedicated for current or future use by a carshare service through a deed restriction, condition of approval, or license agreement. Such deed restriction, condition of approval, or license agreement shall grant priority use to any carshare service that can make use of the space, although such spaces may be occupied by other vehicles so long as no carshare organization can make use of the dedicated carshare space(s).

Carshare Service. A service that provides a network of motor vehicles available to rent by members by reservation on an hourly basis or in smaller intervals.

Ceiling Height, Ground Floor. The height from finished floor to finished ceiling of primary rooms on the ground floor, not including secondary rooms which include, but are not limited to: bathrooms, closets, utility rooms, and storage spaces.

Ceiling Height, Upper Floor(s). The height from finished floor to finished ceiling of primary rooms on the floor(s) above the ground floor, not including secondary rooms which include, but are not limited to: bathrooms, closets, utility rooms, and storage spaces.

Cellar. That portion of a building between floor and ceiling which is wholly or partly below grade and so located that the vertical distance from grade to the floor below is equal to or greater than the vertical distance from grade to ceiling. A cellar shall not be counted as a story, for the purpose of height standards.

Center. Concentration of ground floor shopping, restaurants, and services, with additional offices and housing located above, within a Walkable Urban context..

Chamfered. A transitional edge between two faces of an object. Sometimes defined as a form of bevel, it is often created at a 45° angle between two adjoining right-angled faces.

Chamfered Facade Corner. An external wall of a building joining two perpendicular exterior walls, typically at a symmetrical, 45 degree angle creating a beveled edge to the building rather than a 90 degree corner.

Civic. A term defining not-for-profit organizations that are dedicated to arts, culture, education, religious activities, recreation, government, transit, and public parking facilities.

Civic Building. A structure operated by governmental or not-for-profit organizations and limited to civic and related uses.

Civic Space. An outdoor area dedicated for public gathering and civic activities. See Section 08.040 (General to Civic Space).

Common Courtyard. An entry court, forecourt, or courtyard shared by multiple residential units or commercial spaces. See Subsection 10.030.3.A.(4) for measurement method.

Common Open Space. An entry court, forecourt, courtyard, or other on-site open space shared by multiple residential units or non-residential units. See Subsection 10.030.3.A.(3) for measurement method.

Common Space (syn. Common Area). A portion of a development held in common and/or single ownership, is not reserved for the exclusive use or benefit of an individual tenant or owner, and is available for use by all persons who reside or work in the building or on the design site. See Subsection 10.030.3.A.(3) for measurement method.

Communication Equipment Building. A building housing operating electrical and mechanical equipment necessary for the conduct of a communications business with or without personnel.

Communications Tower. Any structure which supports an antenna.

Community Center. A multi-purpose meeting and recreational facility typically consisting of one or more meeting or multi-purpose rooms, kitchen, and/or outdoor barbecue facilities, that are available for use by various groups for such activities as meetings, parties, receptions, dances, etc.

Community Development Director. See "Director."

Condominium. An estate in real property consisting of an undivided interest in common in a portion of the property together with a separate interest in space called a unit, the boundaries of which are described on a recorded final map, design site map, or condominium plan. The condominium may be commercial, industrial, residential, or any combination. [Civil Code §783, §1351(f)].

Condominium Conversion. The conversion of an existing structure into separately owned commercial, industrial, or mixed-use units.

Corner Element. A physical distinction in a building at the corner of two streets or a street and public space.

Corner Entry. An entrance located on the corner of a building.

Cornice. The crown molding of a building or element.

Cottage Court. See Section 05.080 (Cottage Court).

Courtyard (syn. Court). An unroofed area that is completely or partially enclosed by walls or buildings on at least two sides and often shared by multiple residential units or non-residential units, not including off-street parking. See Subsection 10.030.3.A.(4) for measurement method.

Courtyard Building, Neighborhood and Core. See Section 05.110 (Neighborhood Courtyard) and Section 05.150 (Core Courtyard).

Coverage

1. **Coverage, Accessory Structures.** The sum of the footprint area of all structures on a design site.
2. **Coverage, Building.** The floor area of the largest story of a building divided by the total design site area.
3. **Coverage, Design Site.** The portion of the design site expressed as a percentage that is covered in buildings or other structures.

Co-working Space. A facilitated environment which may contain shared facilities including, but not limited to: conference rooms, reception services, phones, and other business amenities. Work spaces are used by a recognized membership who share the site in order to interact and collaborate with each other as part of a community and to reduce duplicated costs by sharing facilities. The uses shall have externally observable attributes similar to uses allowed in the zone in which that they are located. Equipment is limited to those which do not generate noise or pollutants in excess of what is customary within a typical office environment. Such space located in a research & development building may use equipment consistent with research & development uses. Co-working space may be interchangeably referred to as "incubator space."

Cul-de-sac. A street which connects to another public street only at one end and is not planned for later extension.

Crawl Space. A shallow unfinished uninhabitable space beneath the floor or under the roof of a building, that provides access to utility, structural, and other building components not readily accessible from the habitable portions of the building.

Crenel. A notch between two merlons (solid upright section of a crenellated parapet), often found in medieval architecture.

Crenellated. Having regularly-spaced, often rectangular gaps, often referring to a parapet or battlement in medieval architecture.

Crenellation. The series of regularly-spaced, often rectangular crenels along a parapet.

D. Definitions

Dangerous or Objectionable Elements. Any land or building structure used or occupied in any manner so as to create any dangerous, injurious, noxious, or otherwise objectionable fire, explosive, or other hazard; noise or vibration, smoke, dust, odor, or other form of air pollution; heat, cold, dampness, electrical, or other disturbance; glare; liquid or solid refuse or wastes; or other substance, condition or elements in such manner or in such amount as to adversely affect the surrounding area or adjoining premises.

Days. Calendar days unless this FBC specifies otherwise.

Dedication. The transfer by a subdivider to a public entity of title to real property or an interest therein, or of an easement or right in real property, the transfer of facilities, the installation of improvements, or any combination of these.

Defensible Space. A public, private, or semi-private residential environment whose physical characteristics—building layout and site plan—function to allow inhabitants themselves to become key agents in ensuring their security.

Density Bonus. A density increase over the maximum allowable residential density of the zone.

Dentils. Small, rectangular blocks found under a cornice in classical architecture. A decorative element, dentils bear resemblance to teeth, their namesake.

Department. The Marin County Community Development Agency.

Depth, Ground-Floor Space. The distance from the street-facing facade to the rear interior wall of the ground-floor space available to an allowed use.

Depth-to-Height Ratio. The relationship of the depth of a space measured perpendicular to a building divided by the average height of the buildings adjacent to the space.

Design Site. A portion of land within a parcel, delineated from other design sites and/or parcels to accommodate no more than one building type. The main purpose of a design site is to allow a parcel large enough to contain more than one building type to contain multiple building types while not requiring the legal subdivision of the parcel into additional parcels.

1. **Design Site, Corner.** A design site located at the intersection of two or more streets, where they intersect at an interior angle of not more than 175 degrees. If the intersection angle is more than 175 degrees, the design site is considered an interior design site.
2. **Design Site, Flag.** A design site not meeting minimum design site frontage standards and where access to a public or private street is provided by means of a long, narrow driveway between abutting design sites.
3. **Design Site, Interior.** A design site abutting only one street.
4. **Design Site, Through.** A design site with two or more frontage lines that do not intersect.

Design Site Area. The total square footage or acreage of horizontal area included within the design site lines.

Design Site Coverage. See "Coverage."

Design Site Depth. The horizontal distance between the front design site line and rear design site line of a design site measured perpendicular to the front design site line.

Design Site Line. The perimeter and geometry of a design site demarcating one design site from another.

1. **Design Site Line, Front.** One of the following:
 - a. The frontage line in the case of a design site having a single frontage line;
 - b. The shortest frontage line in the case of a corner design site with two frontage lines, neither of which are adjacent to a thoroughfare or a design site with independent frontage;
 - c. The frontage line generally perceived to be the front design site line in the case of a corner design site with three or more frontage lines, none of which are adjacent to a thoroughfare or a design site with independent frontage;
 - d. The frontage line adjacent to a thoroughfare in the case of a corner design site with two or more frontage lines, one of which is adjacent to a thoroughfare;
 - e. The frontage line adjacent to a design site with independent frontage in the case of a corner design site with two or more frontage lines, one of which is adjacent to a design site with independent frontage; or
 - f. The frontage line adjacent to the front design site line of an adjacent design site in the case of a through design site.
2. **Design Site Line, Rear.** That design site line opposite the front design site line.
3. **Design Site Line, Side.** Design site lines connecting the front and rear design site lines.

Design Site Width. The horizontal distance between the design site lines measured perpendicular to the front design site line.

Detached. Separate or unconnected.

Development Site. The parcel(s) or portion(s) thereof on which proposed structures and improvements are to be constructed.

Diligently Pursued. Continued with constant or appropriate effort.

Director. Director of the Marin County Community Development Agency, an appointed representative.

Display. An item or arrangement of items indoors that is not attached to a window, door or wall.

Disposition, Formal. Composed in a formal arrangement, in a regular, classical, and typically symmetrical manner.

Disposition, Informal. Composed in an informal character with a mix of formal and natural characteristics.

Disposition, Natural. A preservation of the existing natural condition or a composition of elements arranged as they would appear in nature, with irregular shapes and asymmetry.

Distance Between Entries. The horizontal distance between entrances to a building or buildings, measured parallel to the facade.

Dormer. A roofed structure, often containing a window, that projects vertically beyond the plane of a pitched roof. A dormer window (also called dormer) is a form of roof window.

Driveway. A vehicular lane within a design site, or shared between two design sites, usually leading to a garage, other parking, or loading area.

Duplex Side-by-Side. See Section 05.060 (Duplex Side-by-Side).

Duplex Stacked. See Section 05.070 (Duplex Stacked).

Dwelling, Group Living (syn. Cohousing). Dwellings designed for occupancy of groups living together and having a central dining facility.

Dwelling, Multiple. A building designed or used for three or more dwelling units.

Dwelling, Second Unit. A separate, complete housekeeping unit with a separate entrance, kitchen, sleeping area, and full bathroom facilities, which is an attached or detached extension to an existing single-unit structure.

Dwelling Unit. A room or group of internally connected rooms that have sleeping, cooking, eating, and sanitation facilities, but not more than one kitchen, which constitute an independent housekeeping unit, occupied by or intended for one household on a long-term basis.

Dwelling Unit, Stacked. A dwelling unit situated immediately above or below another dwelling unit.

E. Definitions

Eave. The edge of the roof that overhangs the face of the adjoining wall. The bottom of the eave can range from exposed rafters (“open eave”) to a finished horizontal surface (“closed eave”).

Elevated Ground Floor. A ground floor situated above the grade plane of the adjacent sidewalk.

Encroachment. Any architectural feature, structure, or structural element—including, but not limited to, a gallery, fence, garden wall, porch, stoop, balcony, bay window, terrace, or deck—that breaks the plane of a vertical or horizontal regulatory limit by extending: into a setback, beyond the build-to-line into the public frontage, or above a height limit.

Entablature. Syn. Expression Line. A horizontal, continuous lintel on a classical building supported by columns or a wall, comprising the architrave, frieze, and cornice.

Entasis. A slight convex curve in the shaft of a column, introduced to correct the visual illusion of concavity produced by a straight shaft.

Entry. An opening, including, but not limited to, a door, passage, or gate, that allows access to a building.

1. **Entry, Primary.** The opening that allows access to a building directly from the sidewalk along the front facade.
2. **Entry, Service.** An entrance located toward or at the rear of the building intended for the delivery of goods and removal of refuse.

Established Landscape. The point in time at which plants have developed roots into the soil adjacent to the root ball.

Establishment Period. The first year after installing a plant in a landscape.

External Employees. An employee who does not reside at his or her place of employment.

F. Definitions

Facade. See "Building Facade."

Facade Zone. The area between the minimum and maximum setback lines along the front of a design site and along the side street of a corner design site where the building facade is required to be placed. The zone standards identify the minimum amount of facade to be placed in the facade zone. See Subsection 10.030.2 for measurement method. .

Facility. An improvement, structure, or building that is designed and used for a particular purpose.

Fence. A structure, made of wood, metal, masonry, or other material, typically used to screen, enclose, or divide open space for a setback or along a design site line.

Finish Level, Ground Floor. Height difference between the finished floor on the ground floor and the adjacent sidewalk. In the case of a terrace frontage that serves as the public right-of-way, the floor finish level is the height of the walk above the adjacent street. Standards for ground floor finish level for ground floor residential uses do not apply to ground floor lobbies and common areas in multi-unit buildings.

Flex Space. A room or group of internally connected rooms designed to accommodate an evolution of use over time in response to an evolving market demand. Typically designed to accommodate future commercial uses, while accommodating less intense short-term uses, including, but not limited to, residential or live/work, until the commercial demand has been established.

Flood Hazard. The threat of overflow stormwaters having the capability to flood lands or improvements, transport or deposit debris, scour the surface soil, dislodge or damage structures, or erode the banks of channels.

Floor Area. The sum of the gross areas of all stories of a building, measured from the exterior faces of the exterior walls. The floor area shall include any building that has a roof and is enclosed so as to provide shelter from the elements on three or more sides.

Floor to Lot Area Ratio. The floor area of the building divided by the total design site area.

Floor Coverage. See "Coverage."

Floorplate. An area measurement in square feet of either the gross or the rentable floor area of a typical floor in a building.

Floorplate, Commercial. The square footage area measurement of a floorplate dedicated to commercial uses.

Floorplate, Non-residential. The square footage area measurement of a floorplate dedicated to non-residential uses.

Floorplate, Residential. The square footage area measurement of a floorplate dedicated to residential uses.

Flow Rate. The rate at which water flows through pipes and valves, measured in gallons per minute or cubic feet per second.

Footprint Area. The total square footage contained within a footprint.

Footprint, Building. The outline of the area of ground covered by the foundations of a building or structure.

Forecourt. See Section 06.080 (Forecourt).

Form-Based Zone (syn. Transect Zone). One of several zones in this FBC and its associated design and development standards.

Fourplex. See Section 05.090 (Fourplex).

Freestanding Wall. A wall that is separate from a building and supported by independent means.

Front. See "Design Site Line, Front."

Front Loaded. (Front Access). Design sites that provide vehicular access from the front of the design site.

Frontage, Private. The area between the building facade and the back of the sidewalk abutting a street (public or private) or public open space.

Frontage, Public. The area between the on-street parking and the back of the sidewalk.

1. **Avenue/Boulevard.** Any street defined in Marin County Code Title 24 (Development Standards) as an arterial, collector, or industrial commercial road.
2. **Main Street.** A street developed for at least a block on either side with a mix of commercial and residential uses or exclusively with businesses.
3. **Street.** Any road, as defined in Marin County Code Title 24 (Development Standards).

Frontage Line. The design site line(s) of a design site fronting a street (public or private) or a civic space.

Frontage Type. A physical element configured to connect the building facade to the back of the sidewalk abutting a street or public open space depending on the intended physical character of the zone.

Fuel Station, Private. A private motor fuel dispensing facility exclusively serving the business occupying the subject property and not involving either wholesale or retail sales of motor vehicle fuels to other individuals or businesses.

Funeral Home. A room or chapel from which funeral services may be conducted.

Furniture Area. An area of space that allows for the placement of furniture without restricting the movement of pedestrians.

G. Definitions

Gable. A vertical wall in the shape of a triangle formed between the cornice or eave and the ridge of the roof.

Gallery. See Section 06.120 (Gallery).

Ganged. Refers to windows designed/found in an array of two or more.

Garage. A structure, or part thereof, used or intended to be used for the parking and storage of motor vehicles.

1. **Garage, Private.** A building or portion of a building, in which only motor vehicles used by the tenants of the building or buildings on the premises are stored or kept.
2. **Garage, Public.** A structure or portion thereof, other than a private garage, used for the storage, sale, hire, care, minor or major repair, or refinishing of self-propelled vehicles or trailers; except, that a structure or part thereof used only for storage or display of self-propelled passenger vehicles, but not for transients, and at which automobile fuels and oils are not sold and motor driven vehicles are not equipped, repaired, or hired, shall not be deemed to be a public garage

Glazing. Openings in a building in which glass is installed.

Grade. The finished ground level at any point along the exterior walls of a structure. Where walls are parallel to and within five feet of a sidewalk, alley or other public way, the level above ground shall be measured at the elevation of the sidewalk, alley or public way. Also see "Grade, Finished."

Grade, Finished. The final ground surface elevation after the completion of grading or other site preparation related to a proposed development that conforms to an approved Grading Permit or Building Permit. In cases where substantial fill is proposed, "finished grade" shall be established by the Director consistent with design sites in the immediate vicinity and shall not be, nor have been artificially raised to gain additional building height. Also see "Grade."

Grade, Pre-Development. The grade of a design site prior to any site improvements related to the proposed development.

Grading. Earthwork performed to alter the natural contours of an area.

Green Building Practices. A whole-systems approach to the design, construction, and operation of buildings and structures that helps mitigate the environmental, economic, and social impacts of construction, demolition, and renovation. Green building practices including, but not limited to, those described in the LEED™ rating system recognize the relationship between natural and built environments and seek to minimize the use of energy, water, and other natural resources and provide a healthy, productive environment.

Gross Floor Area. The total floor area inside the building envelope, including the external walls, but not including the roof.

Gross Parking Area. The total area of parking space and drive included on a design site.

Gross Residential Acreage. The total area, measured in acres, included within the design site lines of a residential development.

Ground Floor. The floor of a building located nearest to the level of the ground around the building.

Ground Floor Ceiling Height. Height from finished floor to finished ceiling of primary rooms on the ground floor, not including secondary rooms including, but not limited to: bathrooms, closets, utility rooms, and storage spaces.

Guest House. A detached structure accessory to a single dwelling, accommodating living/sleeping quarters, but without kitchen or cooking facilities.

H. Definitions

Habitable Space. The portion of a building that is suitable for human occupancy.

Hand-Wrought. Wrought iron finish that appears hammered or shaped by hand

Hardscape. Paving, decks, patios, and other hard, non-porous surfaces.

Height

1. **Height, Number of Stories.** The number of stories in a structure allowed above adjacent finished grade. See "Stories."
2. **Height, Overall.** The vertical distance between adjacent finished grade and the highest part of the structure directly above. See Subsection 10.030.3.A.(6) for measurement method.
3. **Height, Highest Eave/parapet.** The vertical distance between adjacent finished grade and the highest eave or parapet of the building. See Subsection 10.030.3.A.(6) for measurement method.

Height, Above Grade. See Section 22.20.060 (Height Measurement and Height Limit Exceptions).

Height Measurement on a Sloping Design Site. This is addressed in Subsection 10.030.1.B.(4).

High Water-use or Non-drought-Tolerant Plant. A plant that will require regular irrigation for adequate appearance, growth, and disease resistance.

Historic Resource. Any resource that has been designated as historic and listed in the historic resource inventory.

Historical Structure. Any building or structure listed on or eligible for listing on the national, state, or local register of historic resources.

House. See Section 05.050 (House).

House-Scale Building. A building that is the size of a small-to-large house and detached from other buildings, typically ranging from 24 feet to as large as 80 feet overall, including wings.

I. Definitions

Impervious. The area of any surface that prevents the infiltration of water into the ground including, but not limited to, roads, parking areas, concrete, and buildings.

Improved. An area which has been paved or planted and is permanently maintained as such.

Improvement. The product of any modification to a site structure or building, not including maintenance or repairs.

Infill. The development of vacant land that was bypassed by earlier waves of development and is now largely surrounded by developed land.

Irrigation Efficiency. The measurement of the amount of water beneficially used divided by the amount of water applied. Irrigation efficiency is derived from measurements and estimates of irrigation system, characteristics, and management practices.

Irrigated Landscape Area. An entire design site less the building footprint, driveways, non-irrigated portions of parking lots, and other hardscape areas. Landscape areas encompass all portions of a development site to be improved with planting and irrigation. They include water bodies including, but not limited to, fountains, swimming pools, and ponds. Natural open spaces without irrigation systems are not included.

J. Definitions

No specialized terms beginning with the letter J are defined at this time.

K. Definitions

Kitchen. A room that is utilized for the preparation of food and contains a kitchen sink.

L. Definitions

L-Shaped (syn. Ell). A horizontal form for the main body of a building or a massing composition, also referred to as an "Ell" which is an extension at a right angle to the length of a building.

Landing. A level area at the top or bottom of a staircase or between one flight of stairs and another.

Landscaping. Flowers, shrubs, trees, or other decorative material of natural origin.

LEED™ Rating System. The most recent version of the Leadership in Energy and Environmental Design (LEED™) Commercial Green Building Rating System, or other related LEED™ rating system, approved by the U.S. Green Building Council.

Lined Building. A two-part building consisting of an exterior occupiable building specifically designed to mask the interior building, which consists of a parking structure, building with few windows, or a parking lot, from a frontage.

Liner Building. An occupiable structure specifically designed to mask a parking lot or a parking structure from a frontage.

Lintel. A horizontal architectural member spanning and usually carrying the load above an opening

Listed Resource. See "Historic Resource."

Live/Work. An integrated housing unit and working space, occupied and utilized by a single household in a structure, either single-unit dwelling or multiple-unit dwelling, that has been designed or structurally modified to accommodate joint residential occupancy and work activity, and which includes:

1. Complete kitchen space and sanitary facilities; and
2. Working space reserved for and regularly used by one or more occupants of the unit.

Living Area. The interior habitable area of a dwelling unit, including basements and attics, but not including garages or any accessory structure.

Loading Dock(s). A platform where cargo from vehicles can be loaded or unloaded.

Loading Spaces, Off-street. Permanently improved and maintained areas on the design site dedicated to loading and unloading of materials, equipment, and merchandise.

Lodging. See "Bed and Breakfast" or "Hotel or Motel."

Low-Water-Use or Extra Drought-Tolerant Plant. A plant that can survive without irrigation throughout the year once established, although supplemental water may be desirable during drought periods for improved appearance and disease resistance.

M. Definitions

Main Body. The primary massing of a primary building. See Subsection 10.030.3.A.(1) for measurement method.

Main Facade. The front facade of a building.

Main Street Building. See Section 05.160 (Main Street Building).

Major. Having a greater size, scope, effect, characteristic, or quality relative to the other corresponding sizes, scopes, effects, characteristics, or qualities; or being the greater of two or more.

Maker Shopfront. See Section 06.090 (Maker Shopfront).

Massing. The overall shape or arrangement of the bulk or volume of a building and structures.

Median. A planted or paved area which separates two roadways or divides a portion of a road into two or more lanes.

Minor. Having a lesser size, scope, effect, characteristic, or quality relative to the average size, scope, effect, characteristic, or qualities; or being the lesser of two or more.

Mixed-Use. Multiple functions within the same building or the same general area through superimposition or within the same area through adjacency.

Mobile Home. A vehicle, other than a motor vehicle, designed and equipped to contain one or more dwelling units to be used without a permanent foundation, and which is in excess of 8 feet in width and in excess of 40 feet in length.

Moderate Water-Use or Semi-Drought-Tolerant Plant. A plant that can survive throughout the year with occasional irrigation.

Multiplex. See Section 05.130 (Multiplex).

Multi-Unit Building. A residential, non-residential, or mixed-use building in which there exists three or more separate units with direct exterior access and in which there are appurtenant shared facilities. Distinguishing characteristics of a multi-tenant building or use may, but need not, include common ownership of the real property upon which the building or use is located, common wall construction, and multiple occupant use of a single structure.

N. Definitions

Neighborhood Center. A walkable environment that provides a mix of civic, institutional, and/or commercial uses.

New Construction. Structures for which the "start of construction" commenced on or after the effective date of this FBC.

Nonconforming Design Site. A design site that was legally created before the effective date of this FBC and does not comply with the minimum area, depth, width, or other applicable standards of the zone it is located.

Nonconforming Site Improvement. A site improvement (e.g., fences, landscaping, parking, walls, etc.) that conformed to the standards of the previous zoning that lawfully existed before the effective date of this FBC and does not conform to the present standards of the zone in which it is located.

Nonconforming Structure or Building. A structure or building that lawfully existed before the effective date of this FBC and does not conform to the present standards of the zone in which it is located.

Nonconforming Use. A use of a building, structure, or site, or portion thereof, or a building, structure or facility itself, which was lawfully established and maintained but, because of the application of this FBC to it, does not conform to the present standards of the zone in which it is located.

Non-Street Frontage. Building facades that do not face a street or civic space.

O. Definitions

Off-Street Parking. The area(s) located on a design site available for temporary storage of passenger vehicles, including a public or private parking lot where parking is the principal use of the property.

Open Space. See "Civic Space."

Open Space Easement. See "Scenic Easement or Open Space Easement."

Open Structure. An accessory structure having a roof constructed of lattice or other roof material which allows light and air to pass through a minimum of 50 percent of the roof surface. Additionally, the sides of an open structure consist only of support posts and decorative or functional elements including, but not limited to, braces and railings such that light and air can pass through a minimum of 75 percent of each side. Open structures include but are not limited to trellises, trellis-like patio covers, and other shade structures. Play structures do not qualify as open structures, but are regulated as minor or major accessory structures.

Oriel Window (syn. Upper Story Bay Window). A window that projects from the building facade or elevation, located on upper floors and may extend for multiple stories.

Outdoor Sales Display. An area where customers are encouraged to examine and/or experience merchandise in their typical configuration and/or manner of use.

Outdoor Storage Building. A building used primarily for storage of goods and materials, and uninhabitable.

Overhead Doors. Doors constructed in horizontally hinged sections that are equipped with hardware that rolls the sections into an overhead position, clear of the opening.

P. Definitions

Parapet. A low wall along the edge of a roof or the portion of a wall that extends above the roof line.

Parcel Map. A map prepared for the purpose of dividing a legal parcel into four or fewer parcels and prepared in compliance with the provisions of this FBC and the Subdivision Map Act (§66410 et seq.) and in a manner to be recorded in the office of the County Recorder.

Parcel, Nonconforming. A legally created parcel which does not conform with current standards for area, width, frontage or other such standards for the zone in which the parcel is located because of annexation or amendments to the title.

Parking Driveway Width. The horizontal measurement of an access driveway to a parking area, measured perpendicular to the direction of travel.

Parkway. That portion of a public right-of-way located between the outermost curb-lane driving lane and the farthest edge of the right-of-way.

Passageway. A pathway unobstructed clear to the sky and extends from a street to one entrance of the accessory dwelling unit.

Passive Recreation. See "Recreation, Passive."

Path of Travel. A continuous, unobstructed way of pedestrian passage.

Patio Cover. A one story, roofed structure, not more than 12 feet in height above adjacent finished grade, used only for recreational and/or outdoor living purposes, that may be attached or detached as an accessory structure to the primary building.

Pedestrian. All people who move along sidewalks at a walking or running pace, including those in wheelchairs, mobility scooters and strollers.

Pedestrian Shed. An area centered on a destination including, but not limited to, a civic space, civic building, or main street. Its size is limited by an average distance that people who walk and those using powered mobility assistance devices are willing to travel, between a $\frac{1}{4}$ and $\frac{1}{2}$ of a mile radius from the destination. Pedestrian sheds are used for planning Walkable Urban areas. To keep distances within this range, the street network supports frequent intersections and provides a variety of different routes to make walking, riding bikes and other forms of active travel convenient.

Pedestrian Orientation. A physical structure or place with design qualities and elements that contribute to an active, inviting, and pleasant place for pedestrians that typically includes most of the following elements:

1. Building facades that are highly articulated at the street level, with interesting uses of material, color, and architectural detailing, located directly behind the sidewalk;
2. Visibility into buildings at the street level;
3. A continuous sidewalk, with a minimum of intrusions into pedestrian right-of-way;
4. Continuity of building facades along the street with few interruptions in the progression of buildings and stores;
5. Signs oriented and scaled to the pedestrian rather than the motorist; and/or
6. Pedestrian orientation may also include: design amenities related to the street level including, but not limited to, awnings, paseos, and arcades; landscaping and street furniture.

Pedestrian-Oriented Businesses. General commercial businesses that allow customers to park once and complete multiple transactions and visits on foot in a context that encourages people to walk instead of drive.

Pedestrian-Oriented Use. A land use that is intended to encourage walk-in customers and that generally does not limit the number of customers by requiring appointments or otherwise excluding the general public. A pedestrian oriented use provides spontaneous draw from sidewalk and street due to visual interest, high customer turnover, and/or social interaction.

Pediment. A triangular space that forms the gable of a low-pitched roof and that is usually filled with relief sculpture in classical architecture.

Pennant. Any lightweight flexible plastic, fabric, or other material, whether or not containing a message of any kind, suspended from a rope, wire, or string, in a series of three or more, designed to move in the wind.

Planning Commission. The Marin County Planning Commission, referred to in this FBC as the Planning Commission.

Plot Plan. A plan for an individual residential design site within an approved subdivision. At a minimum, the plot plan shows the design site property lines with metes and bounds; street address; driveways; grading; proposed locations for structures; public and private improvements (e.g., utility service laterals); retaining walls; trees; and measurements to locate these improvements within the design site.

Podium. A continuous projecting base or pedestal under a building often occupied by parking.

Podium Top. A flat, elevated and open area above a podium that can be used as common area.

Porch. A covered shelter projecting in front of the entrance of a building.

1. **Porch, Engaged.** See Section 06.050 (Porch Engaged).
2. **Porch, Projecting.** See Section 06.040 (Porch Projecting).

Pre-Development Grade. The grade of a design site prior to any site improvements related to the proposed development.

Premises. An area of land with its appurtenances and buildings which because of its unity of use may be regarded as the smallest conveyable unit.

Primary Building. See "Building, Primary."

Primary Living Space. A space within the primary building that is designed as a living room, dining room, or bedroom.

Printing and Processing. Establishments engaged in heavy print shop, typesetting, lithograph, and silk screening (of printed materials only); graphics and art services; sign company; blueprinting; non-retail photographic processing and printing; and art services.

Private Open Space. The area required for each unit in some building types, provided as outdoor yard areas, patios, decks, and balconies, but excluding stairs, entrance decks, and/or landings. Does not include required setbacks.

Private Street. Any street not a public street.

Public Assembly. A gathering of members of the public.

Public Safety Building. Buildings for public utility uses including substations, fire stations, police stations, hospitals, and similar uses.

Public Property. Any property publicly owned outside of the designated public right-of-way.

Public Street. A street for which the right-of-way is owned by or offered for dedication to the public and accepted by the County.

Public Use. A use undertaken by a political subdivision.

Q. Definitions

No specialized terms beginning with the letter Q are defined at this time.

R. Definitions

Rake. The sloped end portion of a roof. Rakes may be close to, or extend from the building to allow for an overhang. Roof rakes can be exposed or closed.

Rear. Opposite of front.

Rear-Loaded (syn. Rear Access). Vehicular access from the rear of the design site.

Recessed Entry. An entrance to a building that is set back from the facade of the building.

Reclassification of Land. An amendment to this FBC, which changes the classification of any property from one zone to another zone provided for in compliance with this FBC.

Recreation, Active. Recreational pursuits usually performed with others and often requiring equipment which required physical alteration to the area in which they are performed. Such areas are intensively used, and include but are not limited to playgrounds; sport courts; baseball/softball and other field sports; and swimming pools.

Recreational Area. Areas of active play or recreation including, but not limited to, sports fields, school yards, picnic grounds, or other areas with intense foot traffic.

Recreation, Passive. Recreational pursuits involving existing natural resources which can be carried out with little alteration or disruption to the area in which they are performed. This includes, but is not limited to such activities as walking; hiking; bicycling; bird and animal watching; and picnicking.

Recreation, Commercial. Recreation facilities operated as a business and open to the general public for a fee.

Recreation, Private, Noncommercial. Recreation facilities operated by a nonprofit organization and open only to bona fide members of such nonprofit organization.

Relocation. The act or process of moving a structure or object from one property to another property or to a different location on the same property.

Renovation

1. A structural change to the foundation, roof, floor, or exterior of load-bearing walls of a facility, or the extension of an existing facility to increase its floor area.
2. Alteration of an existing facility including, but not limited to, significantly changing its function, even if such renovation does not include any structural change to the facility.
3. Remodeling of the building interior or exterior.

Residential. Premises used primarily for human habitation.

Residential Development. Any development that consists entirely of dwellings.

Review Authority. The individual or official Marin County body (the Community Development Director, Planning Commission, or Board of Supervisors) identified by this FBC as having the responsibility and authority to review, and approve or deny the permit applications.

Right-of-Way (ROW). Land dedicated to transportation purposes and/or use by the general public.

Roadside Service Establishment. Service stations, garages, restaurants, motels, hotels, and similar enterprises which provide food, shelter, or necessary automotive services or supplies to travelers.

Rooming and/or Boarding. A dwelling or part thereof other than a hotel where meals and/or lodgings are provided, for compensation, for six or more persons unless otherwise specified, not transients.

Rowhouse. See Section 05.100 (Neighborhood Townhouse) and Section 05.140 (Core Townhouse).

Runoff. Water which is not absorbed by the soil to which it is applied. Runoff usually occurs when water is applied at too great a precipitation rate, when water is applied to saturated soils, or when water is applied to a steep slope.

S. Definitions

Satellite Dish Antenna. Parabolic or spherical antenna whose purpose is to receive and/or transmit radio communication signals to and/or from satellites.

Scenic Easement or Open Space Easement. An easement granted to the public whereby the owner relinquishes or limits the right to construct improvements on the land.

Second Unit. See "Dwelling, Second Unit."

Semi-Public Use. A use owned or operated by a non-profit organization, private institution, or foundation.

Semi-Public Utility Building. A building owned or operated by a non-profit organization, private institution, or foundation, and used to provide utility services to its members or those persons it serves.

Service Entries. Building access for service providers.

Service Facilities. On-site facilities that support grounds maintenance, landscaping, and minor repair service relative to a primary use.

Setback. The distance by which a structure, parking area, or other development feature is separated from a design site line, other structure, or development feature

1. **Setback, Front.** An area extending across the full width of the design site between the front design site line and the primary structure.
2. **Setback, Rear.** An area extending the full width of the design site between a rear design site line and the primary structure.
3. **Setback, Side.** An area between a side design site line and the primary structure extending between the front and rear setback.

Setback, Building. The mandatory clear distance between a design site line and a building.

Setback, Parking. The mandatory clear distance between a design site line and parking.

Setback, Non-Street Frontage. Any side or rear setback not contiguous to a public right-of-way. Such setback shall be measured laterally from the nearest part of that portion of a primary building facing said side or rear setback toward the nearest point of the design site line.

Shared Parking. Any parking spaces assigned to more than one user, where different persons utilizing the spaces are unlikely to need the spaces at the same time of day.

Shopfront. See Section 06.100 (Shopfront).

Shopfront Base. A very low wall, that does not include glass, between the display window(s) of a shopfront and the adjacent sidewalk.

Sidewalk. A paved area along a street intended exclusively for pedestrian use and often installed between a street and design site frontages.

Single-Loaded, Building. A building containing dwellings and/or commercial units without common hallways for access to the dwellings and/or units.

Site Plan. A base sheet that includes the basic information that will appear on all plans including, but not limited to, natural features, roads, buildings, or other structures to remain on-site.

Special Architectural Elements. Church spires; belfried cupolas and domes; monuments; corner or entry towers on residential units; and other similar architectural elements.

Specific Plan. See California Government Code §65450-65457.

Stealth Design. The effect of integrating an element including, but not limited to, a cellular antenna into a building that results in the element not being visible from adjacent public sidewalks and open space.

Street, Front. Street located along the front design site line of a parcel.

Street, Side. Street located along a design site line of a parcel that is not along the front design site line.

Stoop. See Section 06.070 (Stoop).

Storefront. The majority portion of a shopfront frontage that consists of the display window and/or entrance and its components, including windows, doors, transoms, and sill pane.

Story. The portion of a building included between the surface of any floor and the surface of the next floor above it, or if there is no floor above, the space between the floor and the ceiling above. If the finished floor level directly above a basement or cellar is more than six feet above grade for more than 50 percent of the total perimeter, such basement or cellar shall be considered a story.

1. **Story, First.** The lowest story or the ground story of any building, the floor of which is not more than 12 inches below the average contact ground level at the exterior walls of the building.
2. **Story, Half (syn. Attic Story).** A conditioned space that rests primarily underneath the slope of the roof, usually having dormer windows. The half story is identified by the ".5" in the description of maximum height (e.g., 2.5). A half-story is considered a story when its top wall plates, on at least two opposite exterior walls, are four feet or more above the floor of such story.
3. **Story, Mezzanine.** A story which covers one-third or less of the area of the story directly underneath it. A mezzanine story shall be deemed a full story when it covers more than one-third of the area of the story directly underneath said mezzanine story.

Street. A public or permanent private thoroughfare which affords a primary means of access to design site(s).

1. **Street, Front.** Street located along the front design site line.
2. **Street, Side.** Street located along a design site line that is not the front design site line

Street Frontage. The lineal length of that portion of a design site abutting a street.

Street Frontage, Principal. The length of the property line of any one premise parallel to and along the public right-of-way which it borders and which is identified by an officially assigned street address.

Street Tree. A tree planted in open spaces, parkways, sidewalk areas, easements, streets, and rights-of-way.

T. Definitions

Tandem Parking. A parking space deep enough to allow two cars to park, one behind the other.

Terrace. See Section 06.110 (Terrace).

Thoroughfares. A way for use by vehicular, pedestrian, and bicycle traffic that provides access to design sites and open spaces, and that incorporates vehicular lanes and public frontages.

Townhouse, Neighborhood and Core. See Section 05.100 (Neighborhood Townhouse) and Section 05.140 (Core Townhouse).

Transect. A cross-section of the environment showing a range of different habitats. The Natural-to-Urban Transect of the human environment is divided into multiple transect zones that describe the physical form and character of a place according to the intensity of its land use and urbanism. See Table P-1E-B (Summary Table of Transects for Natural, Rural, and Walkable Contexts in Marin County).

Transect Zone. See "Form-Based Zone."

Transit Station. A design site or structure used for the purpose of parking, loading, and unloading freight and passengers from train or bus transportation. May include parking facilities and other commercial amenities to service transit passengers.

Transit Stop. A location where buses stop to load and unload passengers. A transit stop may or may not include a shelter or a pullout.

Transom. Refers to a window; a window above a door or other window built on and commonly hinged to a transom

Tripartite. A method of visually organizing a facade of the building by dividing it up into three sections: the base, middle, and top.

Turf. A surface layer of earth containing mowed grass with its roots. Annual bluegrass, Kentucky bluegrass, perennial ryegrass, red fescue, and tall fescue are cool-season grasses. Bermuda grass, kikuyu grass, seashore paspalum, St. Augustine grass, zoysia grass, and buffalo grass are warm-season grasses.

U. Definitions

Understory. The smaller trees and shrubs below the canopy of large trees.

Unit. See "Dwelling Unit."

Upper Floor. A floor in a building containing habitable space that is located above the ground floor.

Usable Open Space. Common or private open space, excluding the following:

1. Required front setbacks;
2. Areas devoted to parking, driveways, and maneuvering areas;
3. Open space at grade less than 10 feet in its minimum dimension; and
4. Patios, balconies, or decks less than five feet in their minimum dimension.

Use. The purpose for which land, premises, or structure thereon is designed, arranged, or intended, or for which it is or may be occupied or used.

Use, Accessory. A subordinate use of a building, structure, or design site that is customarily incidental to a principal use located on the same parcel.

Use, Principal. The main or primary use or uses conducted on a design site or located within a building or within a portion of a building which is separated structurally from other uses within the same building, not to include an accessory use as defined herein or a subordinate department of a main or primary use.

Use, Temporary. The use of land or premises or a building thereon for a limited period of time which does not change the character of the site, premises, or uses therein.

V. Definitions

Visitability. A basic level of accessibility that enables persons with disabilities to visit others in their dwellings by providing at least one accessible means of egress/ingress for each residential unit.

W. Definitions

Walkable Neighborhood Center. A Walkable Urban environment that provides a concentrated mix of civic, institutional, and/or commercial uses.

Walkable Neighborhood Plan (WNP). A development plan for creating Walkable Urban environments with a mix of housing, civic, retail, and service choices within a compact, walkable, and transit-ready environment. See Section 08.030 (Walkable Community Design).

Walkable/Walkability. The condition when an area is highly interconnected to other areas and appeals to pedestrians for recreational walking or for walking to work, transit, errands, shopping, or restaurants.

Walkway. A paved way located on one or more design sites, used for pedestrian traffic, and used exclusively by the design site owner(s), their guests, and invites.

Wall Plane. A vertical surface defined by the facades of buildings.

Water Table, Architectural Feature. A horizontal projecting string-course of masonry, molding, or a ledge placed so as to divert rainwater from a building.

Width-to-Height Ratio. The ratio of the horizontal size of a space measured perpendicularly to the vertical height of a building. See Subsection 10.030.3.A.(5) for measurement method.

Wing. A structure of at least five feet in depth physically attached to, and secondary to, the main body of a primary building. See Subsection 10.030.3.A.(2) for measurement method.

X. Definitions

No specialized terms beginning with the letter Y are defined at this time.

Y. Definitions

Yard. See "Setback."

Z. Definitions

Zero Design Site Line. A building or structure that is placed on the property line.

Zone. See "Transect Zone."

Zone Map. The zoning map(s) of Marin County, California, together with all amendments.

Zoning Administrator. The duly designated and appointed zoning administrator of the County.

Zoning Code. The Development Code of the County specified in Title 22 (Development Code).

10.030 Measurement Methods

1. Sloped and Steeply Sloped Design Sites

- A. **Applicability.** The standards of Section 04.050 (Slope Standards) apply to sloped and steeply sloped design sites. Slope is measured by taking the vertical distance, or "rise", over the horizontal distance, or "run." The resulting fraction, or percentage, is the "slope" of the land. Sloped and steeply sloped design sites are those areas of land that exhibit the slopes of six percent and greater.
- B. **Methodology.** The following methodology shall be used to identify steep slopes protected in compliance with this Chapter. An example of the methodology is shown in Figure 1 (Example for Defining Sloped and Steeply Sloped Design Sites).
- (1) **Steep Slope Determination.** To qualify as a steep slope, the slope shall be at least six percent with a 10 feet vertical drop over a 100 feet horizontal distance parallel to at least one common contour line. The horizontal measurement shall cross property lines to establish if a steep slope may exist on a design site (i.e., the 100 feet minimum width calculation shall cross a property line if necessary to achieve this minimum width).

Figure 10.030.1: Example for Defining Sloped and Steeply Sloped Design Sites

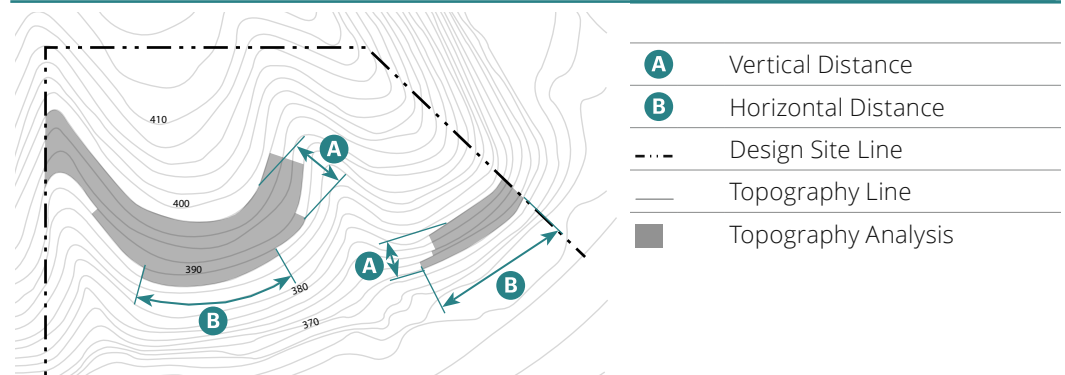

- (2) **Area Calculation.** Step slope areas are calculated based on the square feet of steep slope on the design site as determined in Subsection 1 above. There is no minimum square footage for each slope area.
- First, calculate the square footage of slopes 30 percent and greater. Determine the square footage of each area as well as the sum of these areas for the total site.
 - Second, calculate the square footage of slopes between 29 and 25 percent. Determine the square footage of each area as well as the sum of these areas for the total site.
 - Third, calculate the square footage of slopes between 24 and 20 percent. Determine the square footage of each area as well as the sum of these areas for the total site.
 - Fourth, calculate the square footage of slopes between 15 percent and 19 percent. Determine the square footage of each area as well as the sum of these areas for the total site.
 - Fifth, calculate the square footage of slopes between 10 and 14 percent. Determine the square footage of each area as well as the sum of these areas for the total site.
 - Last, calculate the square footage of slopes between 6 and 9 percent. Determine the square footage of each area as well as the sum of these areas for the total site.

- (3) **Steep Slope Resource Area.** Based on the area calculations in Subsection 2, above, Table 04.050.A (Amount of Sloped Areas Allowed to be Developed) shows the percentage of slope area that shall be included in the resource protection area. The steep slope areas to be protected shall be included in the survey.
- (4) **Sloping Design Site Height.** Design sites with slopes of six percent or more shall measure the maximum height of structures as set forth in the zone and measured vertically from ground level at the front setback line, or if no setback is required, at the center of the design site.

Figure 10.030.2: Example for a Sloped Development Site (<1 acre)

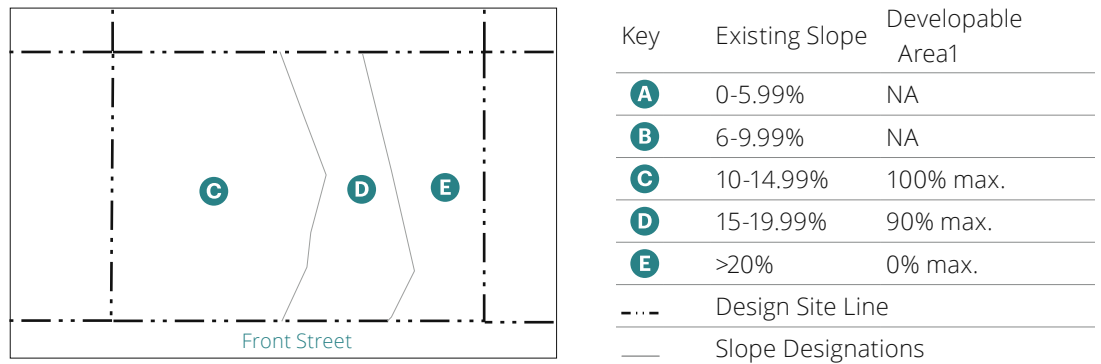
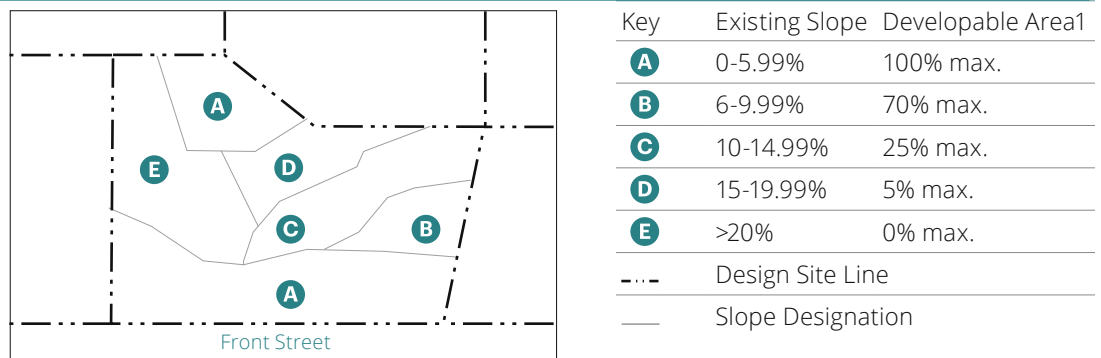

Figure 10.030.3: Example for a Sloped Development Site (>1 acre)



¹ In compliance with the setbacks of the zone, required on-site open space, this Section, and the maximum building footprint standards in Chapter 6 (Building Type Standards).

- C. **Average Slope.** The result of dividing the length of a slope by the difference in elevation at the top and bottom of the slope.
- (1) **Design Sites with Even Slope.** Average slope for design sites with relatively even slope across the site and small design sites is determined by using the following formula:
- (a) $S = ((T - B) \div \text{run}) \times 100$
 - (b) S = average slope
 - (c) T = elevation at top of slope
 - (d) B = elevation at bottom of slope
 - (e) Run = horizontal distance between the top and bottom elevations
- (2) **Design Sites with Uneven Slope.** Average slope of design sites with an uneven slope across the site before grading is determined by using the following formula:
- (a) $S = (1.0029 \times I \times L) \div A$
 - (b) S = average slope
 - (c) I = contour interval in feet
 - (d) L = summation of length of the contour lines in scale feet
 - (e) A = area of the design site in acres

2. **Facade Zone defined by Primary Building/Frontage Type**

- A. **Applicability.** The facade zone standards apply to new primary buildings and their additions along the front and side street of a design site.
 - B. **Methodology.** The required amount is expressed in the zone standards as a percentage. The percentage is calculated as follows through an example for the front facade zone [See Figure 4 (Determining the Required Amount Subject to the Facade Zone)]. The same approach is to be applied to the side street, using the minimum front and rear building setbacks.
- (1) Identify the width of design site (e.g., 50 feet) and apply required side building setbacks (e.g., 5 feet and 5 feet).
 - (2) Subtract the horizontal length between each side setback and the adjacent side design site line from the total width of the design site. The result is the net buildable width of the design site (e.g., 40 feet).
 - (3) Multiply the required minimum percentage in the zone standards (e.g., 50 percent) by the net buildable width of the design site (e.g., 50 feet).
 - (d) The result is the minimum length, in feet, of building facade and frontage type(s) that is required in or abutting the facade zone (e.g., 20 feet).
 - (5) See Figure 5 (Applying the Required Amount to the Facade Zone) for examples that are consistent with the intent of this standard.

Figure 10.030.4: Determining the Required Amount Subject to the Facade Zone

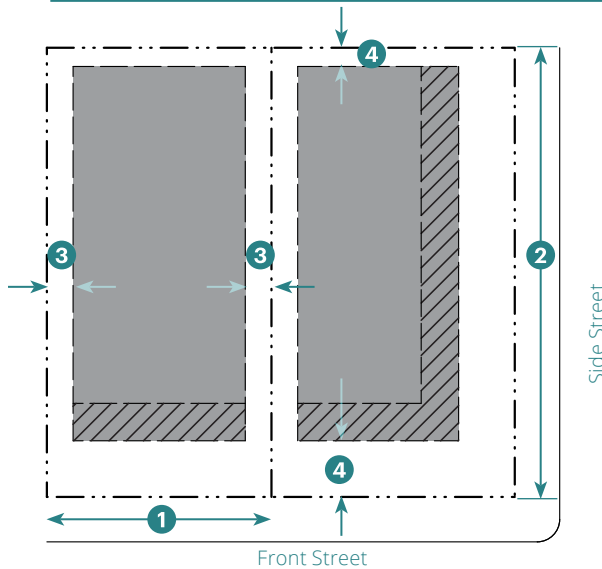



Example Calculation

50'	Design Site Width
- 5'	Side Setback
- 5'	Side Setback
= 40'	Net Buildable Width
40'	Net Buildable Width
x Zone Standard (e.g., 50%)	
= 20'	Required In or Abutting the Facade Zone

- ① Width of Design Site
- ② Depth of Design Site
- ③ Setback to be Subtracted from Design Site Width
- ④ Setback to be Subtracted from Design Site Depth

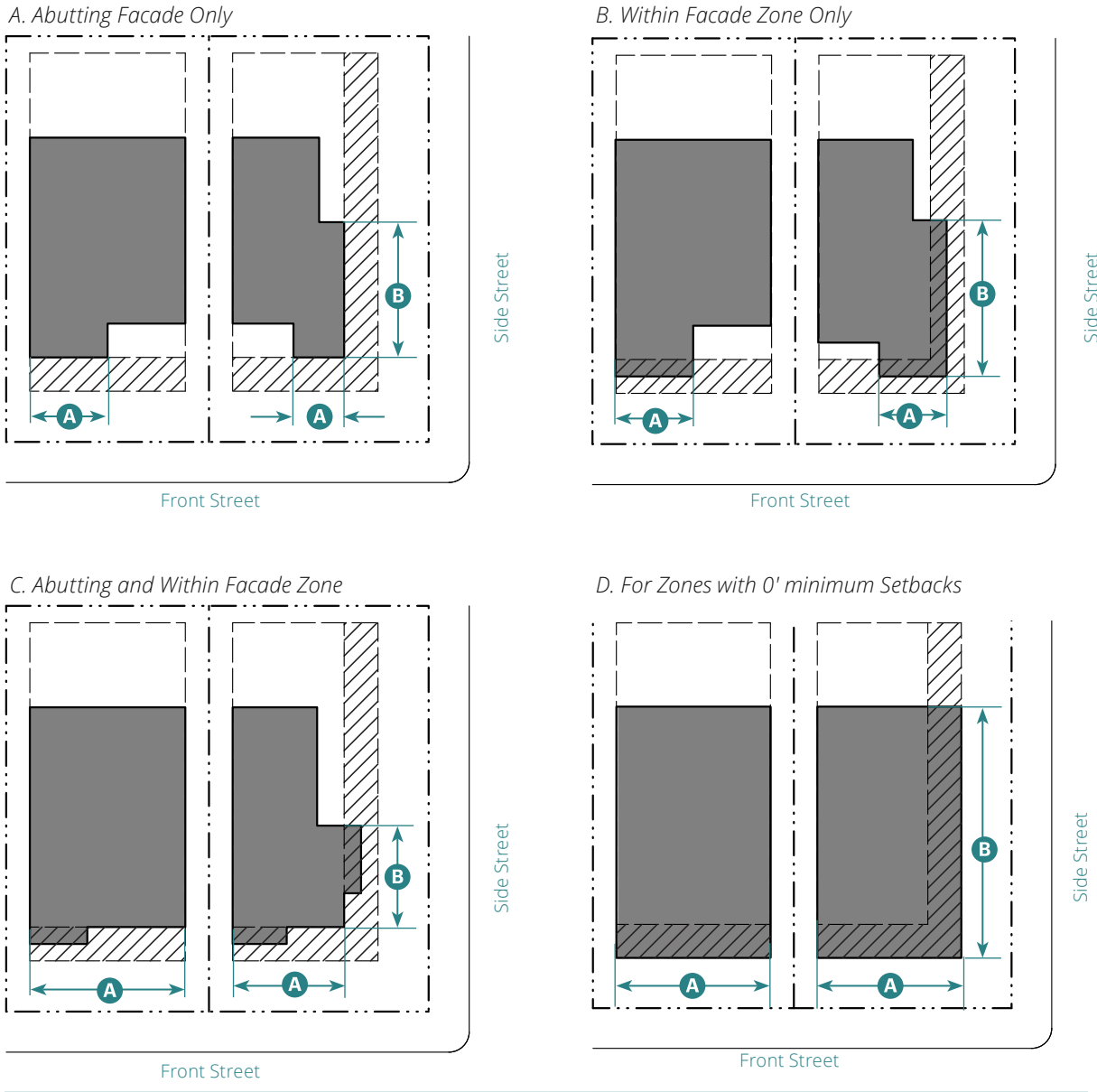
Figure 10.030.5: Applying the Required Amount to the Facade Zone



		Front Street	Side Street
	Facade Zone	50% min. ¹	50% min. ¹
	Buildable Area for Building and Frontage Type(s)	A	B

¹This is an example. See Subsection 5 of the zone for the standard.

3. **Measuring Building Types**

A. **Methodology.** Measurement of width and depth.

- (1) **Main Body.** The width and depth of the main body shall be measured as follows:
 - (a) The width shall be parallel to the front.
 - (b) The depth shall be perpendicular to the front.

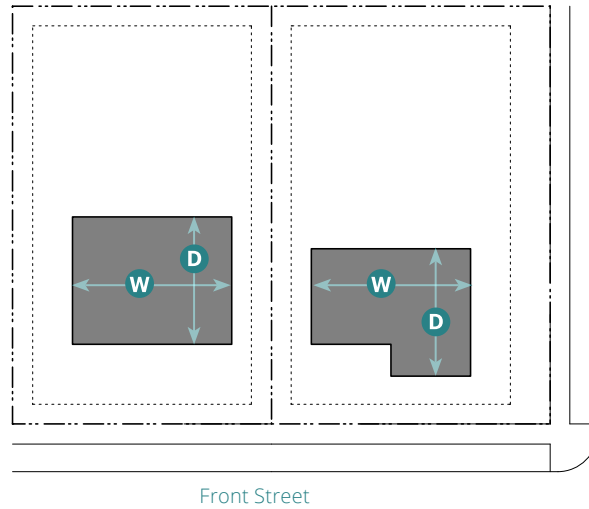

Figure 10.030.6:
Main Body

- W** Width
- D** Depth

- (2) **Wings and Ancillary Structures.** The width and depth of wings and ancillary structures, shall be measured as follows:
 - (a) The width shall be the greater of the two dimensions of the footprint.
 - (b) The depth shall be the lesser of the two dimensions of the footprint.

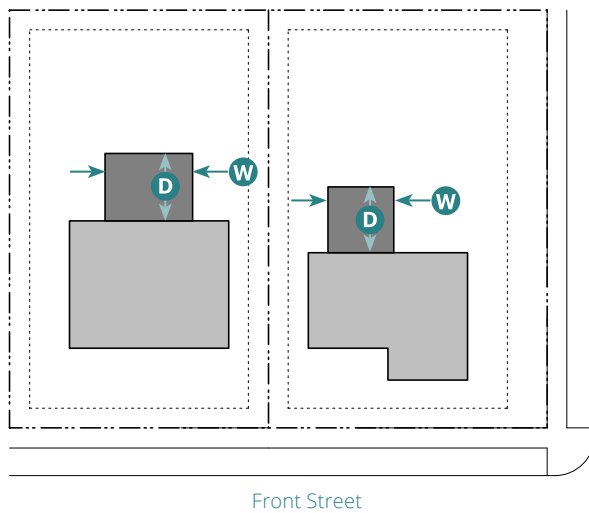

Figure 10.030.7:
Wings and Ancillary Structures

- W** Width
- D** Depth

- (3) **Open Space(s).** The width and depth of open spaces shall be measured as follows:
- (a) The width shall be parallel to the front
 - (b) The depth shall be perpendicular to the front.

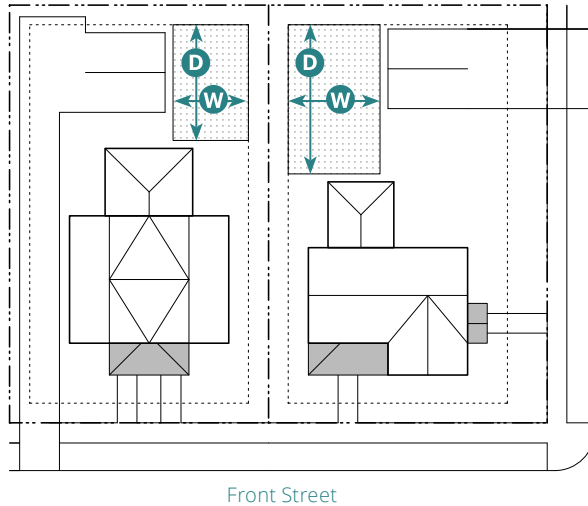

Figure 10.030.8:
Open Space(s)

- W** Width
- D** Depth

- (4) **Courtyard(s).** The width and depth of courtyards shall be measured as follows:
- (a) The width shall be parallel to the front; unless the courtyard is a secondary courtyard accessed directly from a side street.
 - (b) If a secondary courtyard is accessed directly from the side street, the width shall be parallel to the side street.
 - (c) The depth shall be perpendicular to the width.

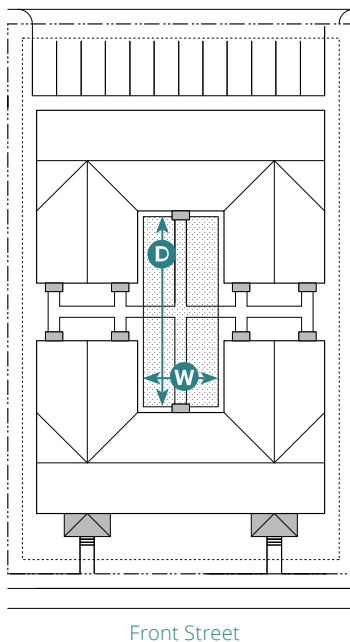

Figure 10.030.9:
Courtyard(s)

- W** Width
- D** Depth

- (5) **Width-to-Height Ratio.** Measurement of width-to-height ratio and depth-to-height ratio of forecourts.
- The width and depth of forecourts shall be measured per Figure 10 (Width-to-Height Ratio).
 - The height of forecourts shall be a measurement of the vertical plane of the building that defines the forecourt.

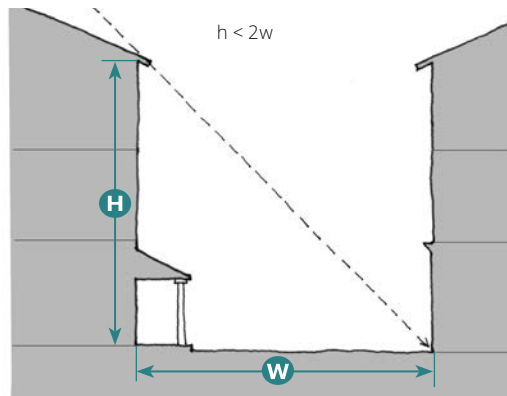

Figure 10.030.10:
Width-to-Height Ratio

-
- W** Width
-
- H** Height

- (6) **Highest Eave/Top of Parapet.**
- Height, Overall.** The vertical distance between adjacent finished grade and the highest part of the structure directly above.
 - Height, Top of Parapet.** The vertical distance between adjacent finished grade and the top of the parapet of the primary building.
 - Height, Highest Eave.** The vertical distance between adjacent finished grade and the highest eave of the primary building.
 - Highest Eave Measurement.** The measurement is to bottom of the eave assembly.
 - Eave.** The edge of the roof that overhangs the face of the adjoining wall. The bottom of the eave can range from exposed rafters to a finished horizontal surface.

Figure 10.030.11: Top of Parapet and Flat Roof

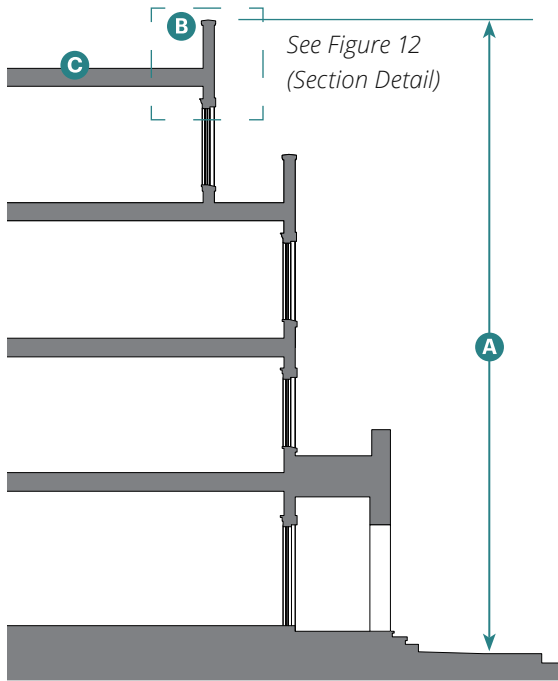
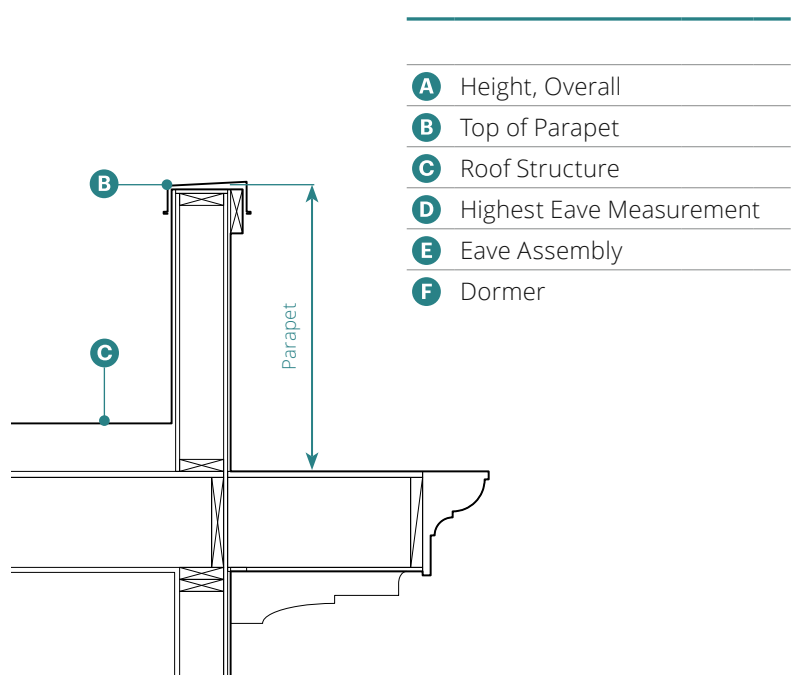

Figure 10.030.12: Section Detail of Top of Parapet and Flat Roof



- A** Height, Overall
- B** Top of Parapet
- C** Roof Structure
- D** Highest Eave Measurement
- E** Eave Assembly
- F** Dormer

Figure 10.030.13: Highest Eave for Pitched Roof

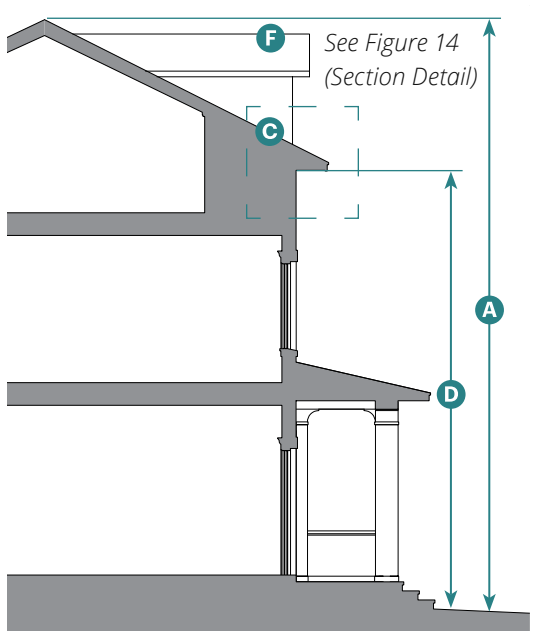
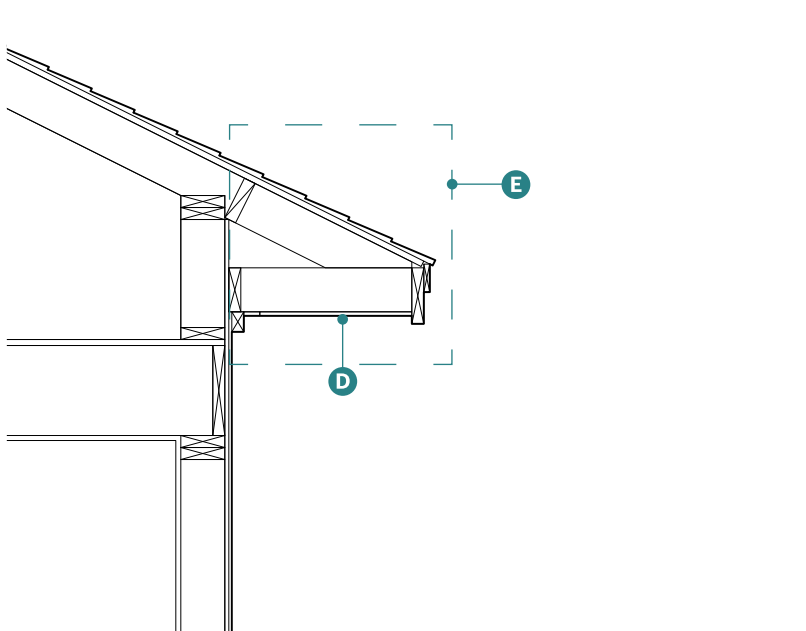

Figure 10.030.14: Section Detail of Highest Eave for Pitched Roof



4. Measuring Bays.

- A. **Applicability.** All buildings, with or without wings must have defined bays, numbering as specified in Subsection 7 (Main Body Massing Composition) of the selected building type.
- B. **Methodology.** The following methodology shall be used to identify bays. An example of the methodology is shown in Figure 2 (Example for Defining Openings and Main Body Massing Composition).
- (1) Select building type (e.g. Duplex Side-by-Side).
 - (2) Select main body massing composition from Subsection 7 (Main Body Massing Composition) of the Building Type (e.g. Gable L (2/5 + 3/5)).
 - (3) Within the main body massing, identify the required number or range of bays (e.g. 3-5 bays).
 - (4) See Figure 15 (Example of House-Scale Massing Composition and Bays) for examples that are consistent with the intent of this standard.

Figure 10.030.15: Example of Massing Composition and Bays

A. Select Main Body Massing Composition.

Gable L (2/5 + 3/5)

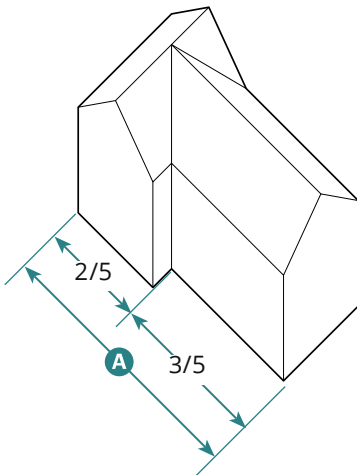

Twin Gable

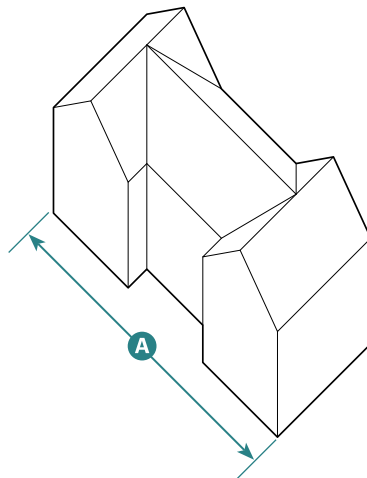

Gabled Courtyard

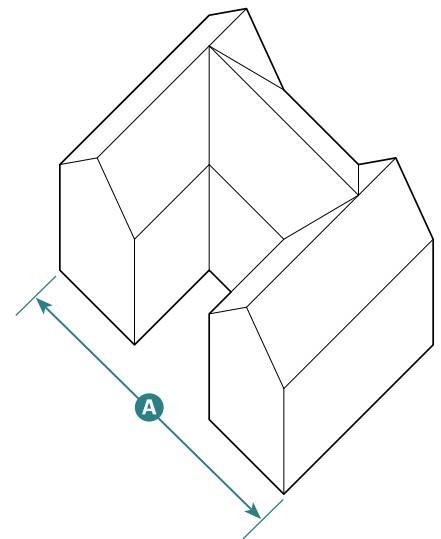

Key

- A** Required Massing Proportions and Number of Bays

B. Identify the Required Number or Range of Bays

Gable L: 3-6 Bays



Twin Gable: 3-6 Bays

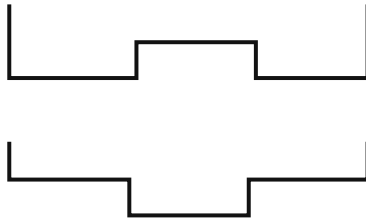

Gabled Courtyard: 3-6 Bays



C. Examples of Bay Compositions in Compliance with Required Massing Proportions

5-Bay Composition

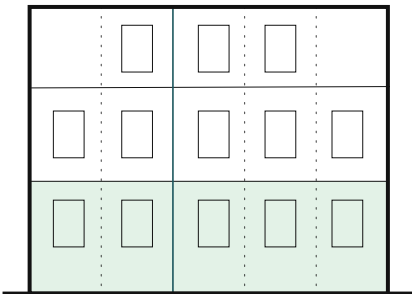

3-Bay Composition

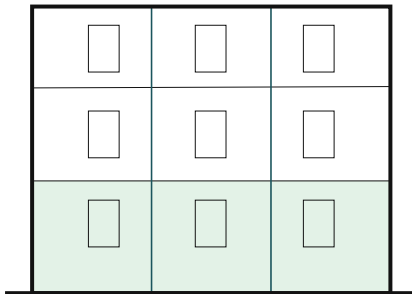

6-Bay Composition

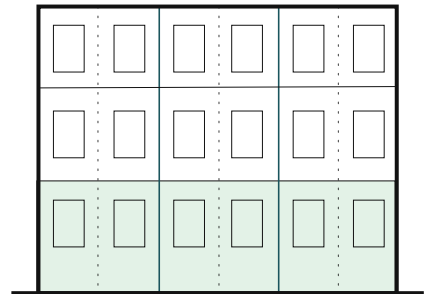

3-Bay Composition

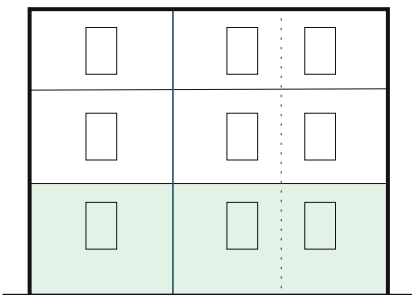

6-Bay Composition

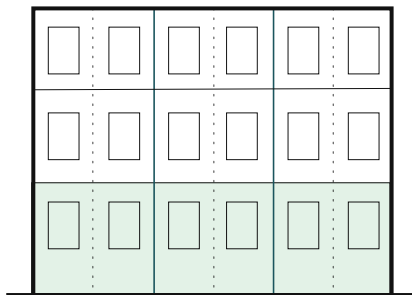

3-Bay Composition

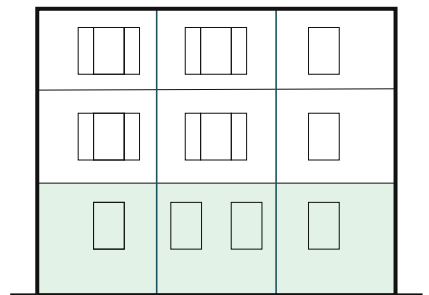

Key

 Ground Floor

This page intentionally left blank